

NÁSTREŠNÉ VENTILÁTORY TORRETTE RF EU

S HORIZONTÁLNYM VÝFUKOM

www.vortice.sk

- Odsávacie ventilátory vhodné pre montáž na strechy obytných, komerčných a priemyselných budov.
- 17 modelov s horizontálnym výfukom a výkonom až 14500m³/h.
- Ventilátory s asynchrónnym indukčným motorom a guľôčkovými ložiskami. Krytie IP44.
- Kryt ventilátora vyrobený z ocele s epoxidovým povrchovým náterom pre zabezpečenie odolnosti voči korózii a predĺženie životnosti.
- Aerodynamicky tvarovaný nasávací otvor z oceľového plechu s polyestrovou povrchovou úpravou.
- Obežné koleso z pozinkovanej ocele so samočistiteľnými, dozadu zahnutými lopatkami, chránené ochrannou mriežkou z nehrdzavejúcej ocele.
- Zariadenie je určené pre odsávanie čistého vzduchu - bez prachu, mastných častíc, sadzí, chemických a korozívnych čínidiel alebo výbušných či horľavých zmesí a ďalších znečistení vznikajúcich z výrobného procesu (napr. piliny...).
- Bezpečnostné lanko pre ukotvenie ventilátora k montážnemu základu.
- Závesné oká pre jednoduchú manipuláciu pri zdvíhaní a transporte.
- Zariadenie musí byť uzemnené.



Príklady montáže

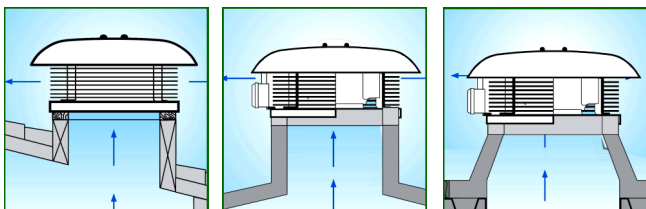

Jednoduchá a ľahká montáž na akýkoľvek typ strechy.

Technické parametre

	Kód	El. napájanie V~50 Hz	El. príkon [W]	Prúd [A]	Počet pólov	[Ot/min]	Vzduchový výkon		Výtlak [Pa]	Akustický tlak Lp (3m) [dB(A)]	Hmotnosť [kg]	Krytie IP	Max. teplota [°C]
							[m ³ /h]	[l/s]					
RF EU M 10 4P	15120	230	92	0,41	4	1345	1365	379	184	35,8	11,7	44	50
RF EU M 15 4P	15121	230	118	0,56	4	1400	1440	400	223	28,3	12,6	44	45
RF EU M 20 4P	15122	230	150	0,66	4	1395	2150	597	281	34,1	13	44	60
RF EU M 30 4P	15123	230	500	2,33	4	1370	4000	1111	428	43,6	25,4	54	50
RF EU M 50 4P	15124	230	470	2,14	4	1328	3900	1083	496	39,7	27,5	54	60
RF EU M 70 4P	15125	230	906	4,42	4	1310	6700	1861	435	47,2	33,8	54	60
RF EU T 10 4P	15126	400	93	0,21	4	1367	1350	375	203	30,5	12,8	44	60
RF EU T 15 4P	15127	400	137	0,28	4	1387	1810	503	254	37,7	13,8	44	60
RF EU T 20 4P	15128	400	258	0,49	4	1395	2980	828	365	36,6	22,3	54	60
RF EU T 30 4P	15129	400	523	1,04	4	1400	4100	1139	538	38,7	25,4	54	60
RF EU T 50 4P	15130	400	700	1,44	4	1400	5100	1417	648	50,3	28,2	54	60
RF EU T 70 4P	15131	400	853	1,63	4	1370	5850	1625	649	49,1	29,5	54	60
RF EU T 70 6P	15132	400	712	1,57	6	900	8100	2250	399	43,8	55,5	54	60
RF EU T 100 4P	15133	400	2700	4,92	4	1430	13100	3639	961	58,3	64,2	54	60
RF EU T 100 6P	15134	400	1210	2,60	6	910	12000	3333	508	46,9	64,7	54	60
RF EU T 100 8P	15135	400	830	1,85	8	650	11000	3055	303	43,5	76,8	54	60
RF EU T 150 6P	15136	400	1990	3,85	6	890	14500	4028	549	46,1	77,3	54	60

Rozměry (mm)

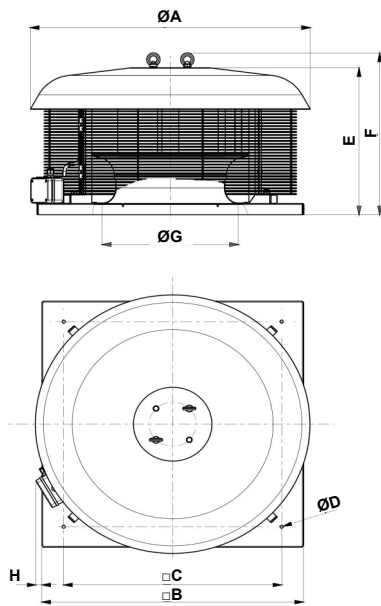

	kód	ØA	∇B	∇C	ØD	E	F	ØG	H
RF EU M 10 4P	15120	540	410	357	11	215	254	242	69
RF EU M 15 4P	15121	540	410	357	11	255	293	235	69
RF EU M 20 4P	15122	540	410	357	11	281	320	261	69
RF EU M 30 4P	15123	720	550	500	11	358	397	325	76
RF EU M 50 4P	15124	720	550	500	11	328	366	325	76
RF EU M 70 4P	15125	720	550	500	11	455	506	410	76
RF EU T 10 4P	15126	540	410	357	11	256	295	235	69
RF EU T 15 4P	15127	540	410	357	11	282	321	255	69
RF EU T 20 4P	15128	720	550	500	11	327	366	292	69
RF EU T 30 4P	15129	720	550	500	11	328	366	325	69
RF EU T 50 4P	15130	720	550	500	11	330	369	362	69
RF EU T 70 4P	15131	720	550	500	11	366	405	362	69
RF EU T 70 6P	15132	945	900	750	11	497	548	460	21
RF EU T 100 4P	15133	945	900	750	11	490	540	456	21
RF EU T 100 6P	15134	945	900	750	11	535	586	510	21
RF EU T 100 8P	15135	945	900	750	11	595	646	576	21
RF EU T 150 6P	15136	945	900	750	11	595	646	576	21

Tlakovo - výkonové křivky

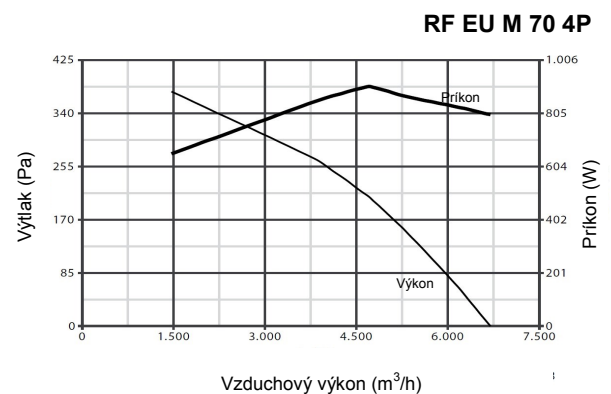
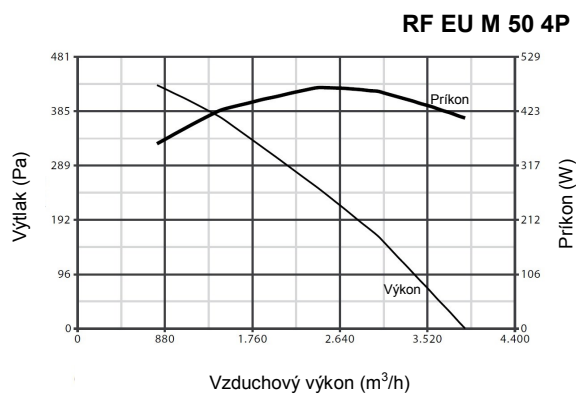
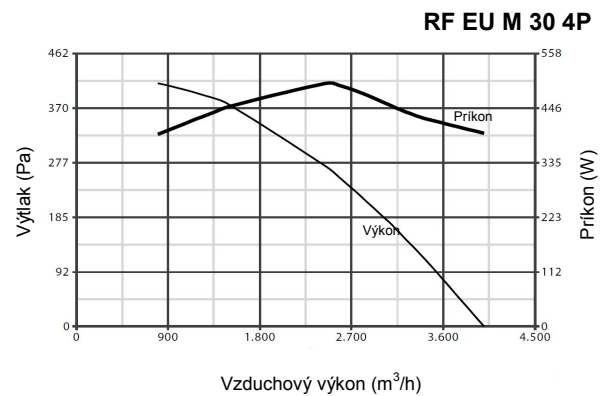
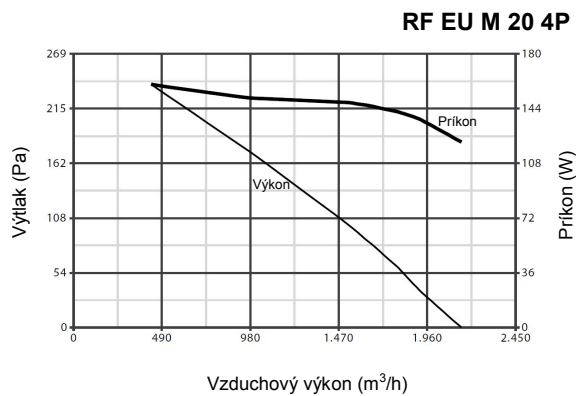
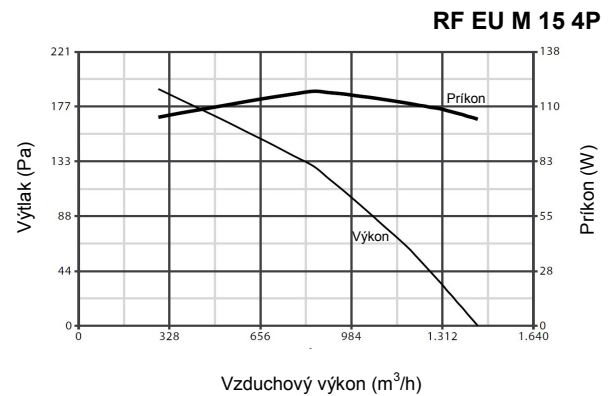
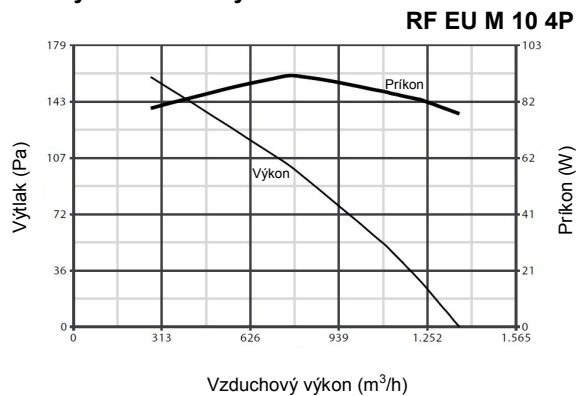

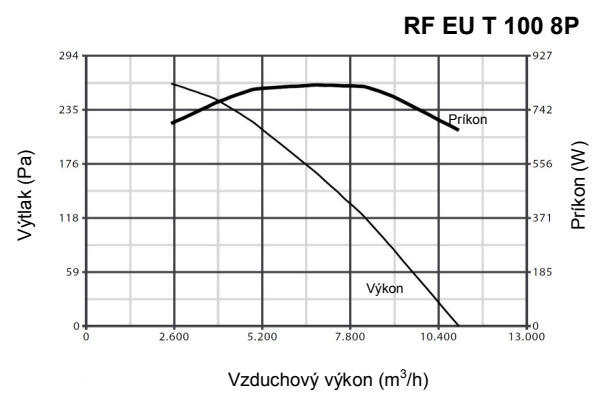
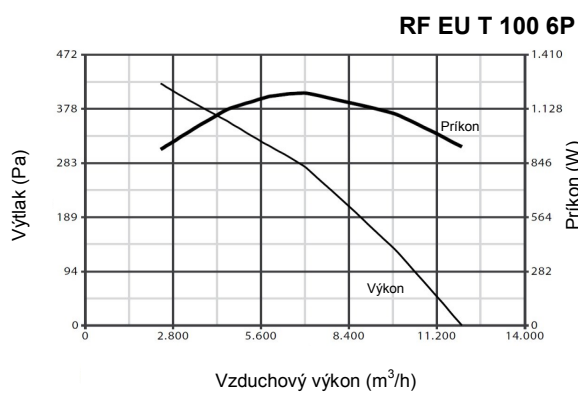
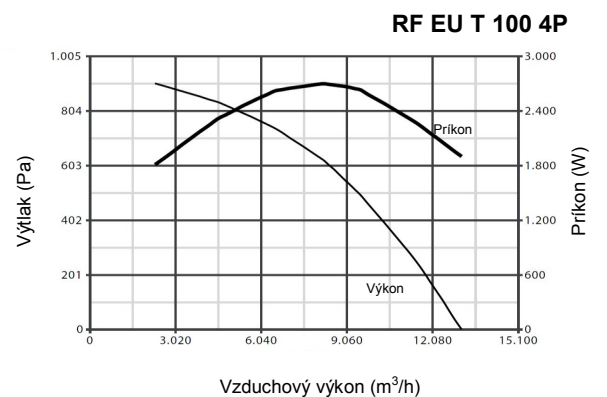
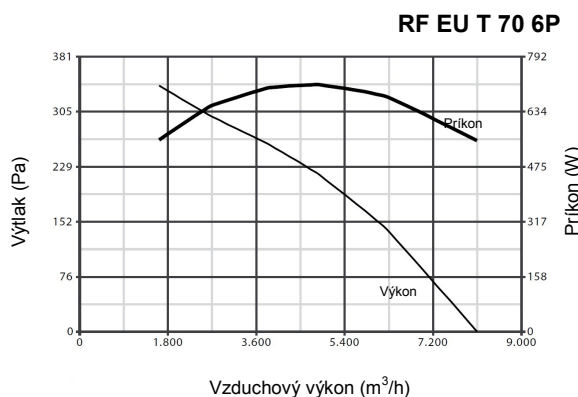
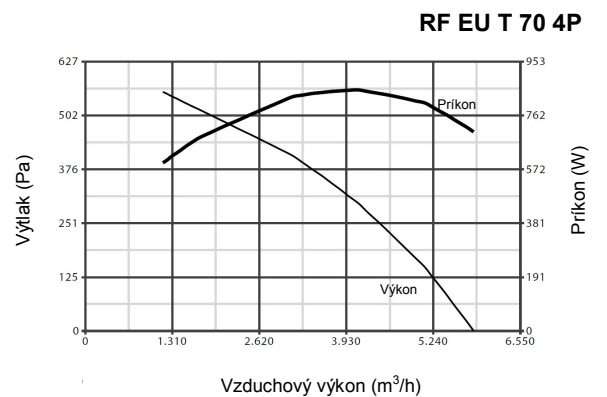
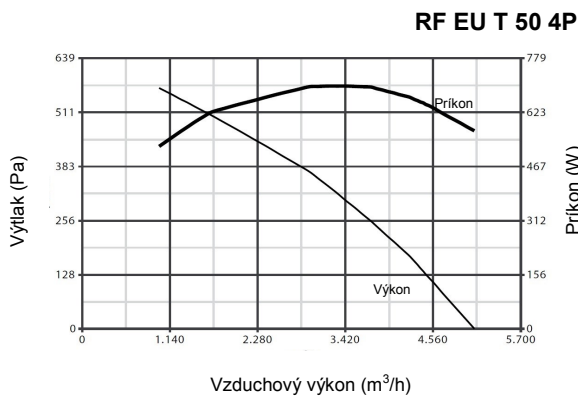
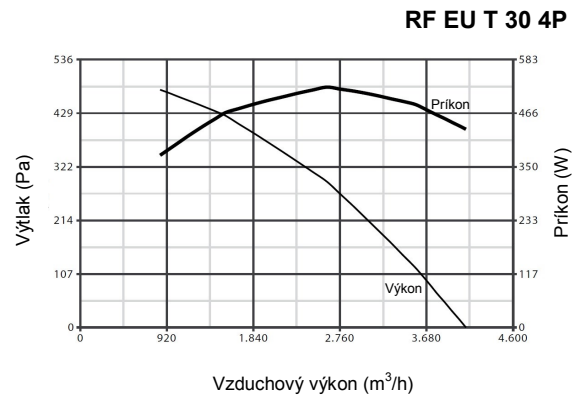
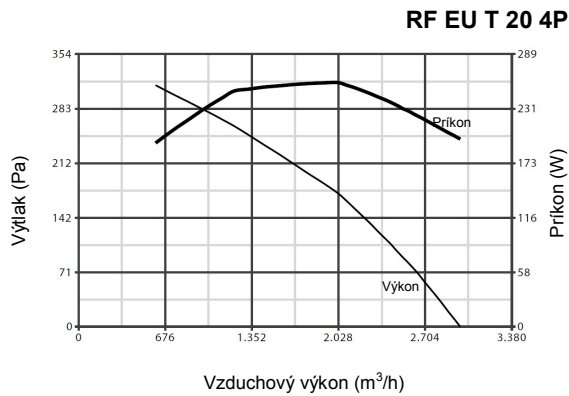
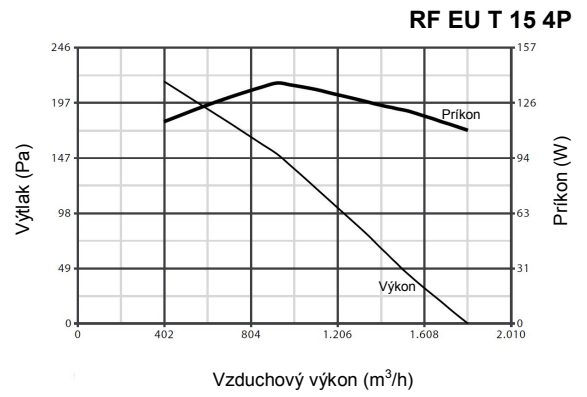
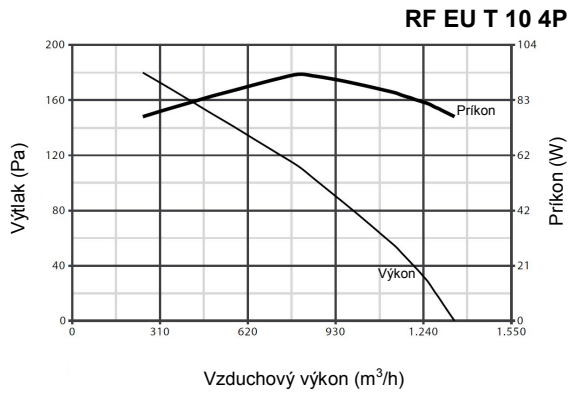

RF EU T 150 6P

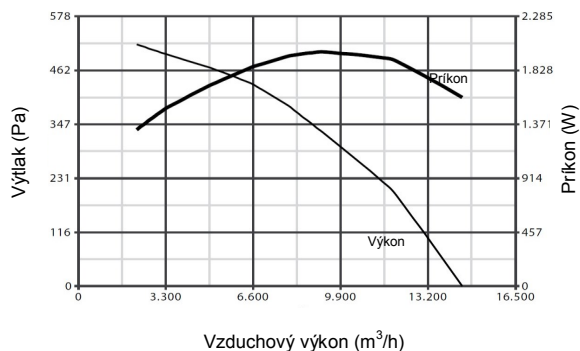

Kompatibilita ventilátorov a regulátorov otáčok

	Kód	C1.5	IRM 30	IRM 40	IRM 50	IRT 15	IRT 35	IRT 40	IREM 3	IREM 9	IRET 6	IREM INVERTER 4 M	IREM INVERTER 6 M	IRET INVERTER 2.5 M	IRET INVERTER 5 M
RF EU M 10 4P	15120	X	X						X	X		X			
RF EU M 15 4P	15121	X	X						X	X		X			
RF EU M 20 4P	15122	X	X						X	X		X			
RF EU M 30 4P	15123			X					X	X		X			
RF EU M 50 4P	15124			X					X	X		X			
RF EU M 70 4P	15125				X								X		
RF EU T 10 4P	15126					X								X	
RF EU T 15 4P	15127					X								X	
RF EU T 20 4P	15128					X								X	
RF EU T 30 4P	15129						X							X	
RF EU T 50 4P	15130						X							X	
RF EU T 70 4P	15131						X							X	
RF EU T 70 6P	15132						X							X	
RF EU T 100 4P	15133							X							X
RF EU T 100 6P	15134							X						X	
RF EU T 100 8P	15135						X							X	
RF EU T 150 6P	15136							X			X				X

Voliteľné príslušenstvo

- C1.5 jednofázový regulátor otáčok
- IRM (30, 40, 50) jednofázový regulátor otáčok
- IRT (15, 35, 40) trojfázový regulátor otáčok
- IREM (3, 9) jednofázový regulátor otáčok
- IRET 6 trojfázový regulátor otáčok
- IREM INVERTER (4 M, 6 M) - frekvenčný menič pre jednofázové modely
- IRET INVERTER (2.5 M, 5 M) - frekvenčný menič pre trojfázové modely
- TR-CU - základový rám
- TR-G - ochranná mriežka
- TR-S - spätná klapka
- TR-B - sací nástavec



Všetky výkonové údaje sú overené nezávislou skúšobňou, čo potvrdzuje štítok kvality a osvedčenie IMQ. Podlieha norme 2012/19/EU-WEEE.