

NOVINKA

EATEX

Axiálne ventilátory do
výbušného prostredia



CE

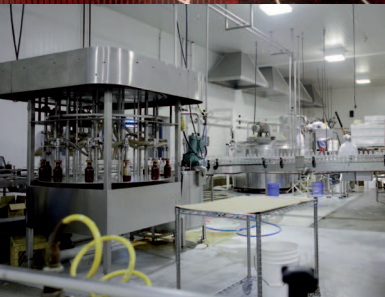



AXIÁLNE VENTILÁTORY DO VÝBUŠNÉHO PROSTREDIA

- 14 modelov (5 s jednofázovým napájaním, 9 s trojfázovým napájaním),
- navrhnuté pre aplikácie, kde hrozí nebezpečenstvo výbuchu z plynov a/alebo prachových častíc,
- vzduchový výkon až do 6900 m³/h,
- dostupný tlak do 200 Pa,
- pracovná teplota od -20°C do +40°C,
- ATEX certifikované indukčné asynchrónne motory,
- vrtuľa s hliníkovým telesom a plastovými lopatkami,
- oceľový rám so špeciálne tvarovaným difúzorom pre zníženie hlučnosti,
- ochranná mriežka z galvanizovanej ocele opatrená ochranným náterom,
- rozbehový kondenzátor u jednofázových modelov umiestnený v nevýbušnom kryte,
- kovové káblové priechodky pre ATEX certifikované elektrické pripojenie,
- chránené základný náterom a polyuretánovou vrchnou vrstvou,
- krytie IP65, trieda izolácie I,
- vyrobené v súlade s normou EN 14986 (navrhovanie ventilátorov určených do potenciálne výbušných prostredí),
- certifikované nezávislou skúšobňou s certifikátom IMQ 10 ATEX 030 X.

PRÍKLADY INŠTALÁCIE

Ventilátory je možné inštalovať do steny, stropu alebo do potrubia.
Vhodnosť umiestnenia musí byť potvrdená oprávnenou osobou.

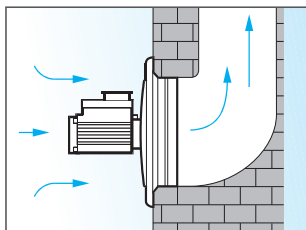
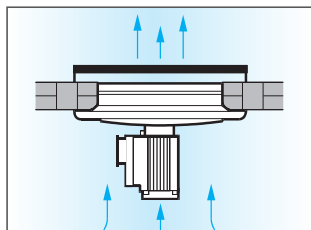
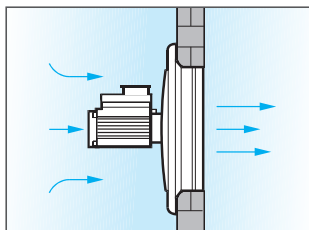

Príklady použitia

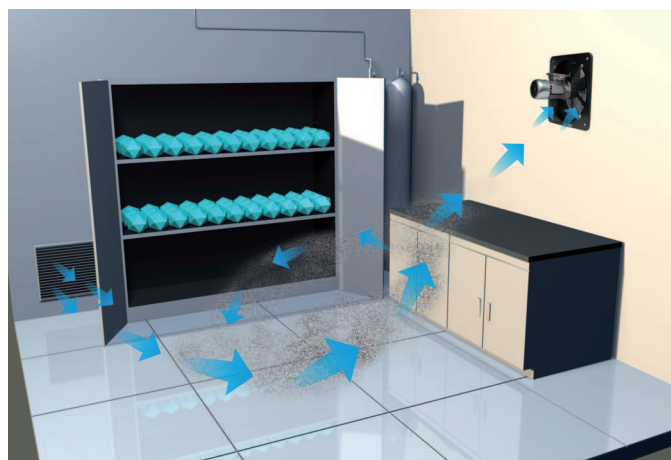
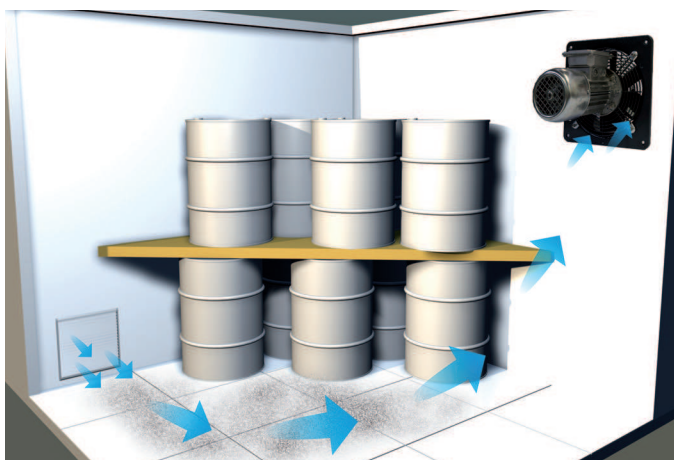

ROZMERY

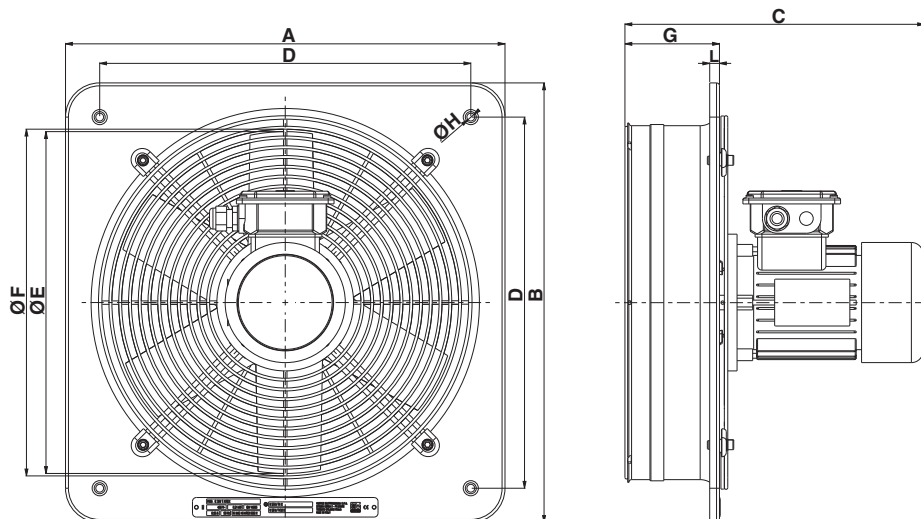

Rozmery (mm)

MODEL	Ø nom.	A	B	C	D	Ø E	Ø F	G	Ø H	L
E 254 M ATEX	250	320	320	305	280	256	250	95	8	10
E 304 M ATEX	315	380	380	307	330	308	300	97	8	10
E 354 M ATEX	355	450	450	307	380	360	350	97	8	10
E 404 M ATEX	400	510	510	327	430	410	400	117	12	15
E 454 M ATEX	450	630	630	325	530	460	448	112	12	15
E 254 T ATEX	250	320	320	305	280	256	250	95	8	10
E 304 T ATEX	315	380	380	307	330	308	300	97	8	10
E 354 T ATEX	355	450	450	307	380	360	350	97	8	10
E 404 T ATEX	400	510	510	327	430	410	400	117	12	15
E 454 T ATEX	450	630	630	325	530	460	448	112	12	15
E 504 T ATEX	500	630	630	325	530	510	498	112	12	15
E 506 T ATEX	500	630	630	361	530	510	498	112	12	15
E 604 T ATEX	630	760	760	340	630	610	598	127	12	15
E 606 T ATEX	630	760	760	361	630	610	598	127	12	15

TECHNICKÉ ÚDAJE

	Model	Kód	Napätie V~50 Hz	El.prikon max. (W)	Prevádzkový prúd (A)	Počet pólov	Ot / min	Max. vzduchový výkon		Maximálny tlak		Akustický tlak Lp dB(A) 3m	Kg
								(m³/h)	(l/s)	(mmH₂O)	(Pa)		
JEDNOFÁZOVÉ	E 254 M ATEX	40301	230	167	0.75	4	1400	1040	288.90	8.90	87.50	63.2	8
	E 304 M ATEX	40302	230	175	0.77	4	1400	1600	444.40	14	137.30	59.6	8.8
	E 354 M ATEX	40304	230	204	0.97	2	1400	2220	616.70	17.30	169.40	66	9.5
	E 404 M ATEX	40306	230	294	1.27	4	1400	3550	986.10	19.80	193.80	62	11.5
	E 454 M ATEX	40308	230	346	1.50	4	1400	4634	1287.20	19.10	187.60	70	14
TROJFÁZOVÉ	E 254 T ATEX	40309	400	121	0.49	4	1400	1050	291.70	9.60	94.20	59.6	7
	E 304 T ATEX	40310	400	162	0.53	4	1400	1585	440.30	14.10	138.30	62	8
	E 354 T ATEX	40313	400	208	0.50	4	1400	2550	708.30	18.40	180.50	66	8.8
	E 404 T ATEX	40314	400	268	0.61	4	1400	3480	966.70	17.40	170.30	64.8	10.5
	E 454 T ATEX	40315	400	345	0.70	4	1400	4443	1234.20	18.20	178.30	69.8	13.6
	E 504 T ATEX	40316	400	293	0.64	4	1400	4900	1361.10	17.70	173.80	72.7	13.6
	E 506 T ATEX	40319	400	166	0.47	6	1000	3823	1061.90	10.10	99.20	64	14.5
	E 604 T ATEX	40317	400	374	0.71	4	1400	6900	1916.70	20.80	203.70	75.4	18
	E 606 T ATEX	40318	400	223	0.49	6	1000	5715	1587.50	12.20	119.40	65.5	19.5

TLAKOVO - VÝKONOVÉ KRIVKY

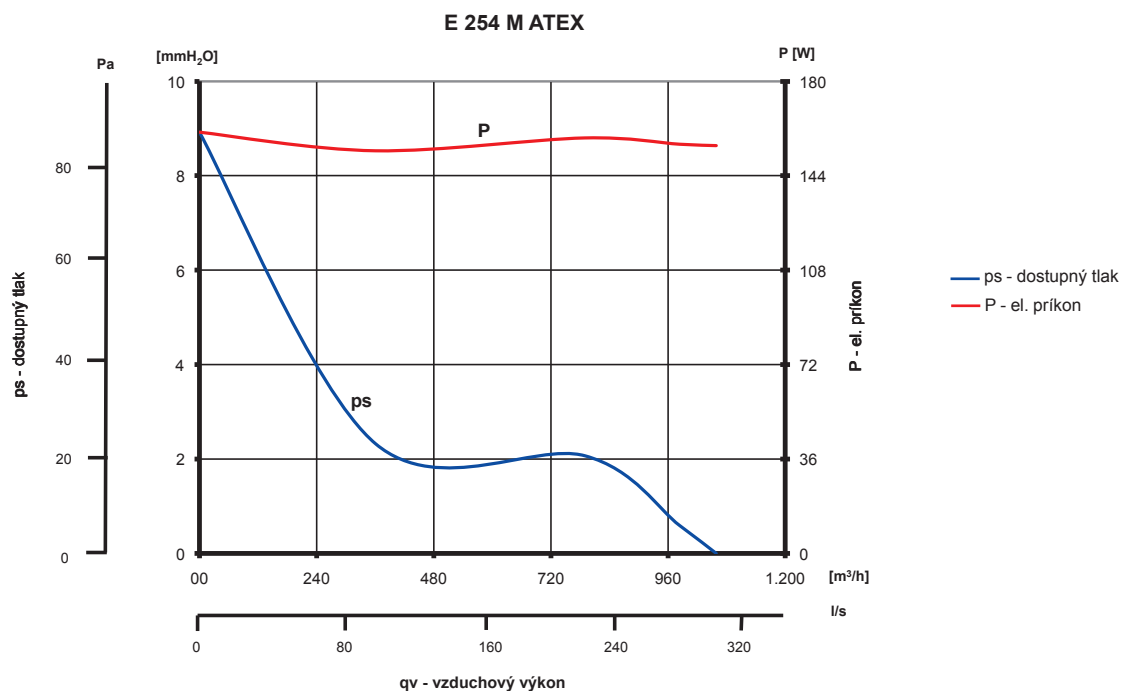

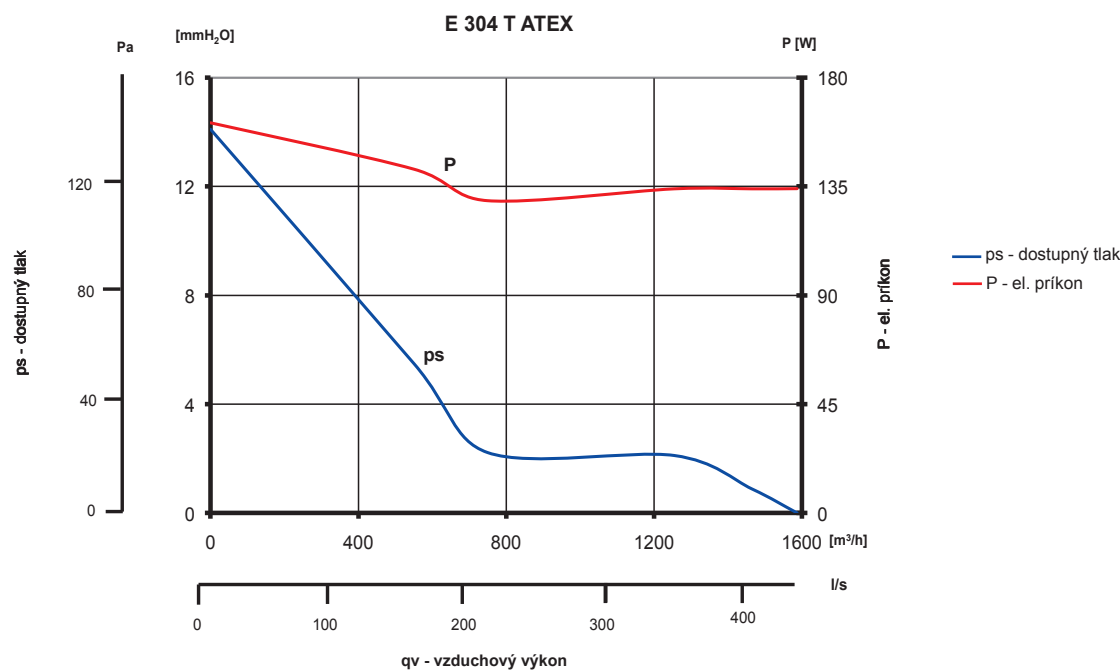
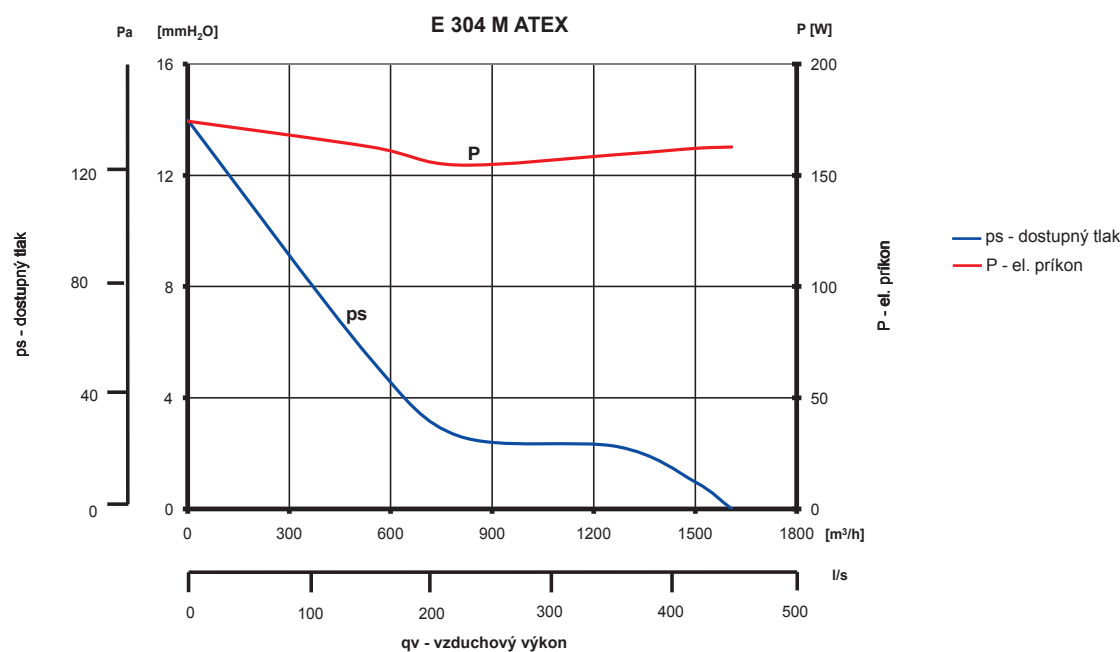
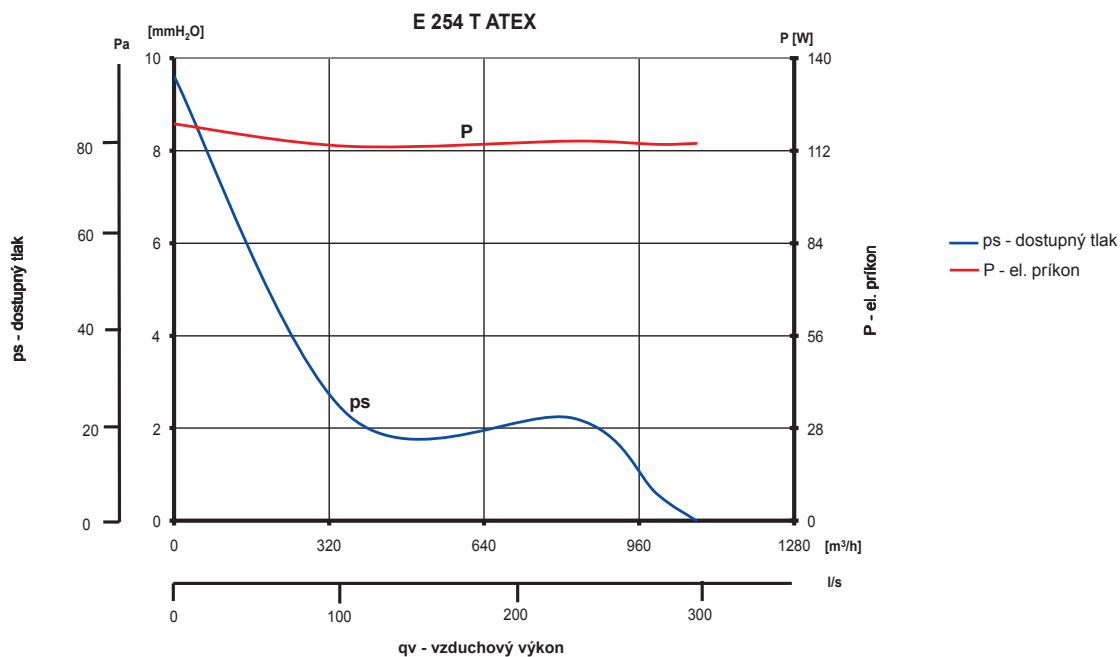

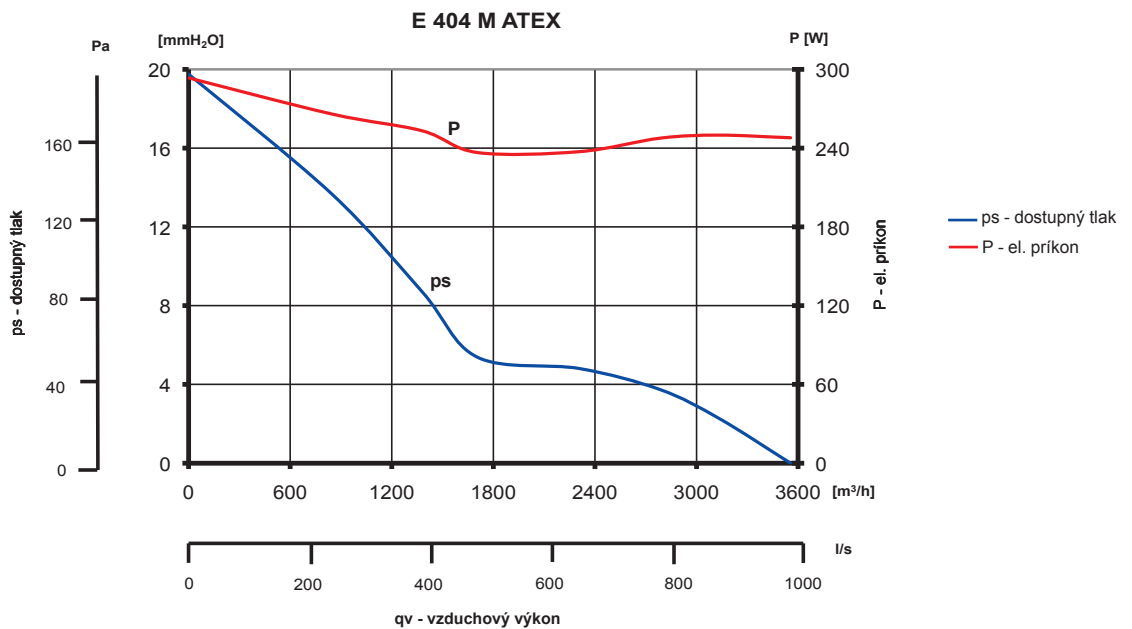
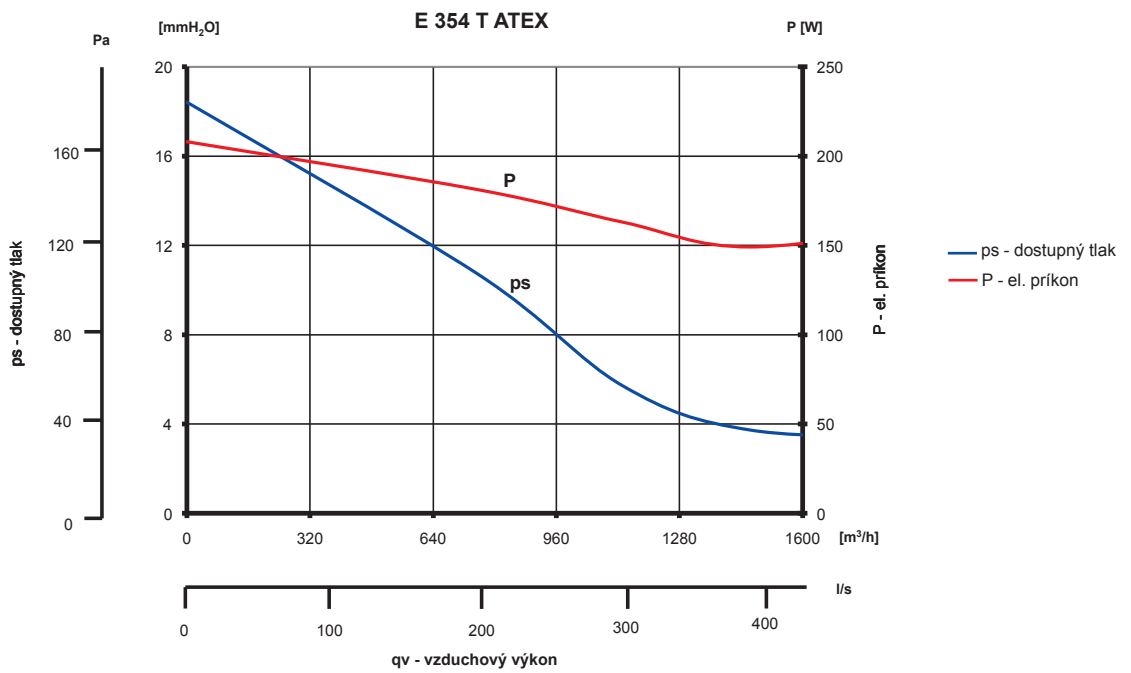
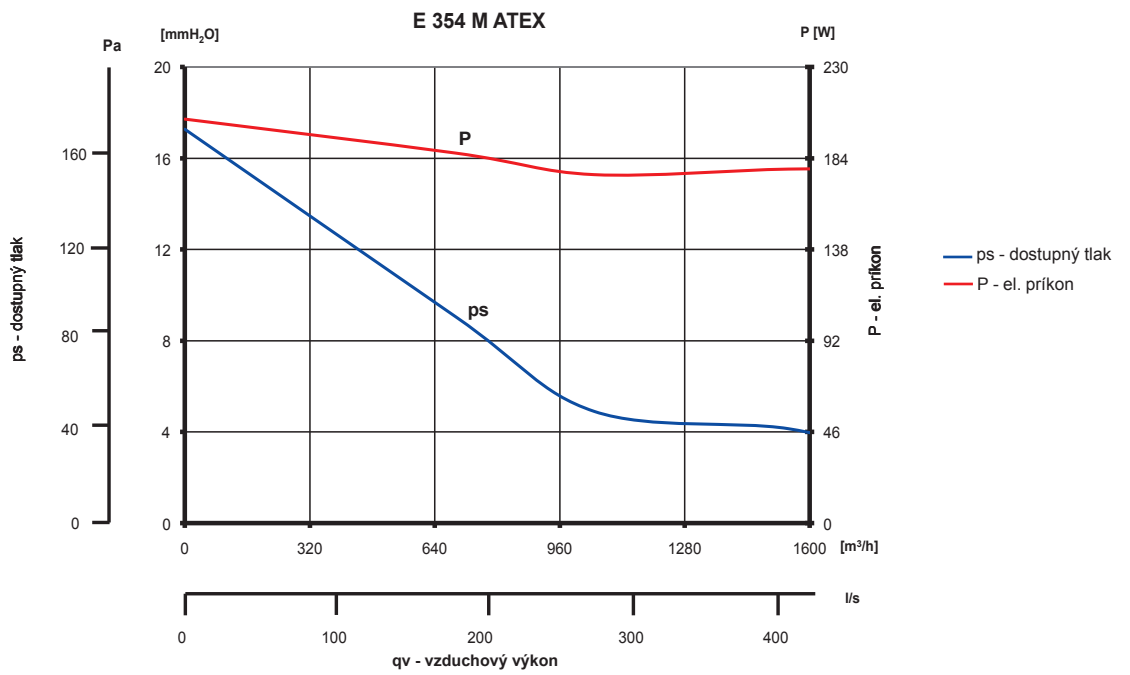

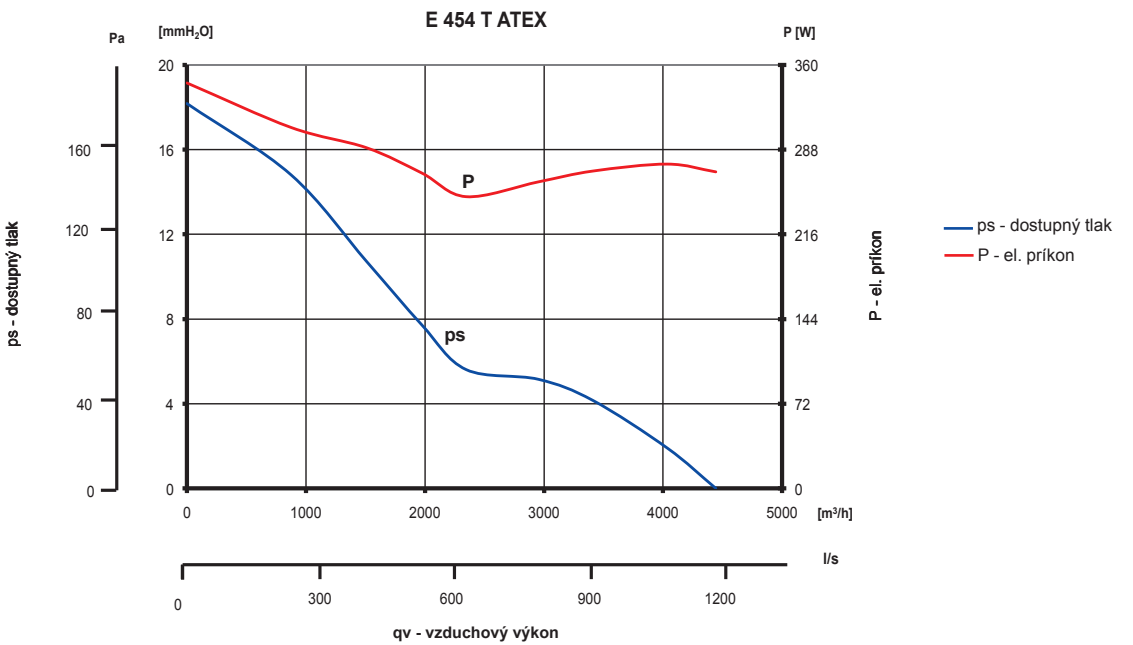
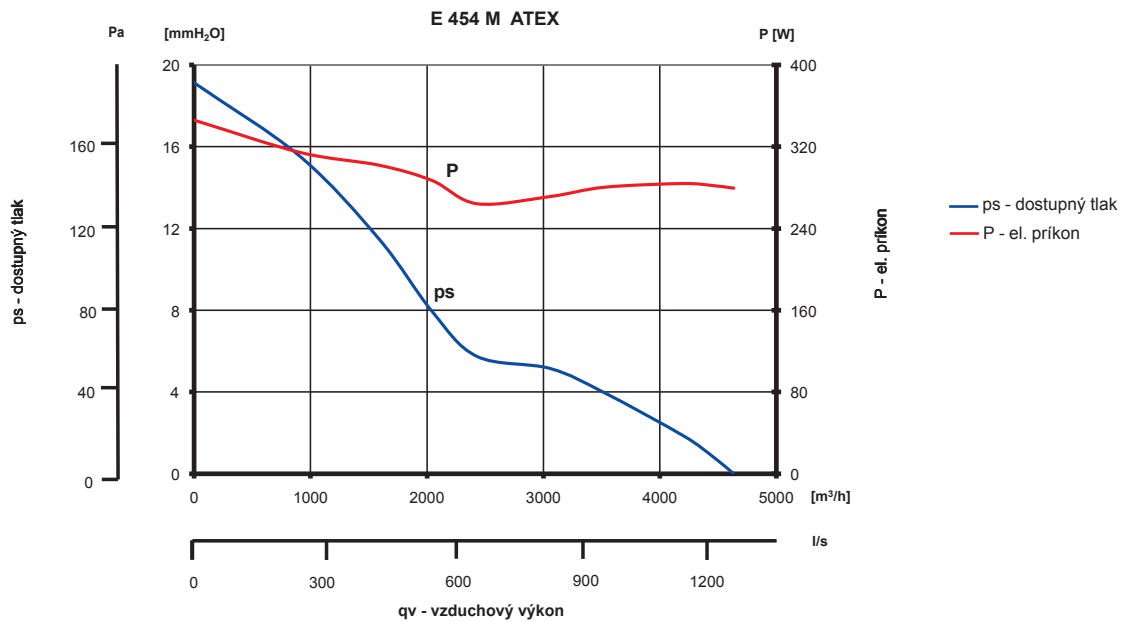
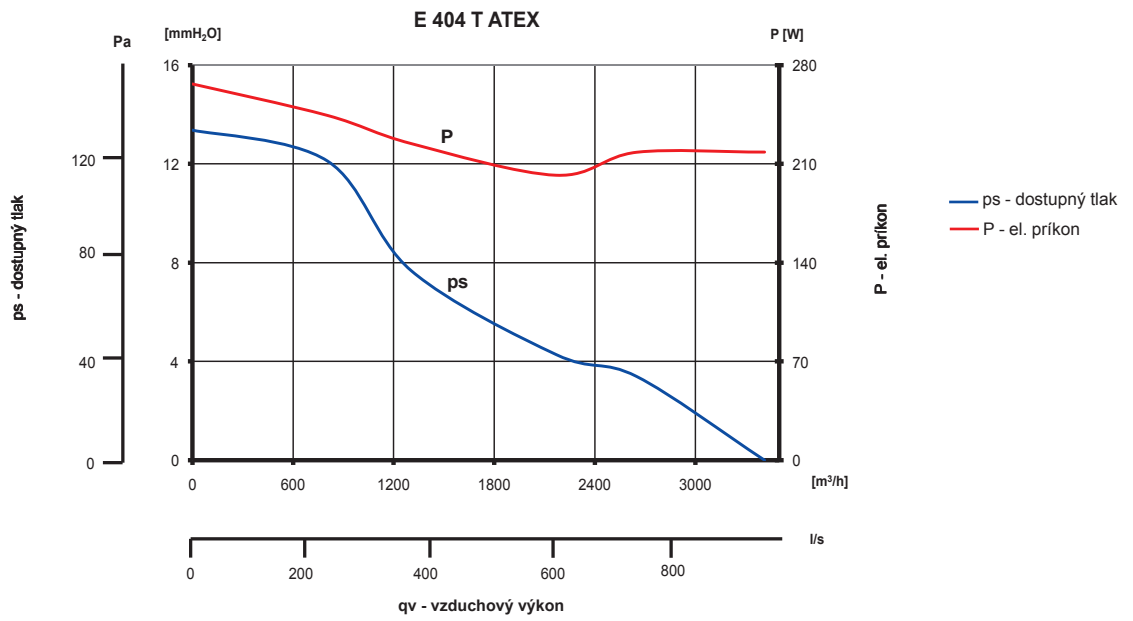

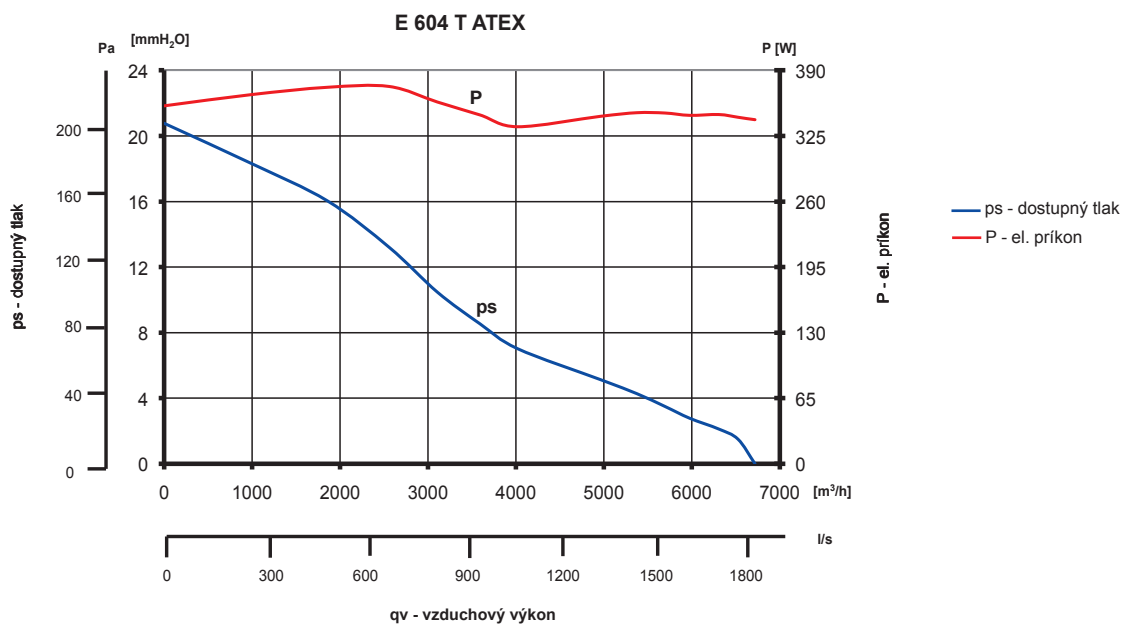
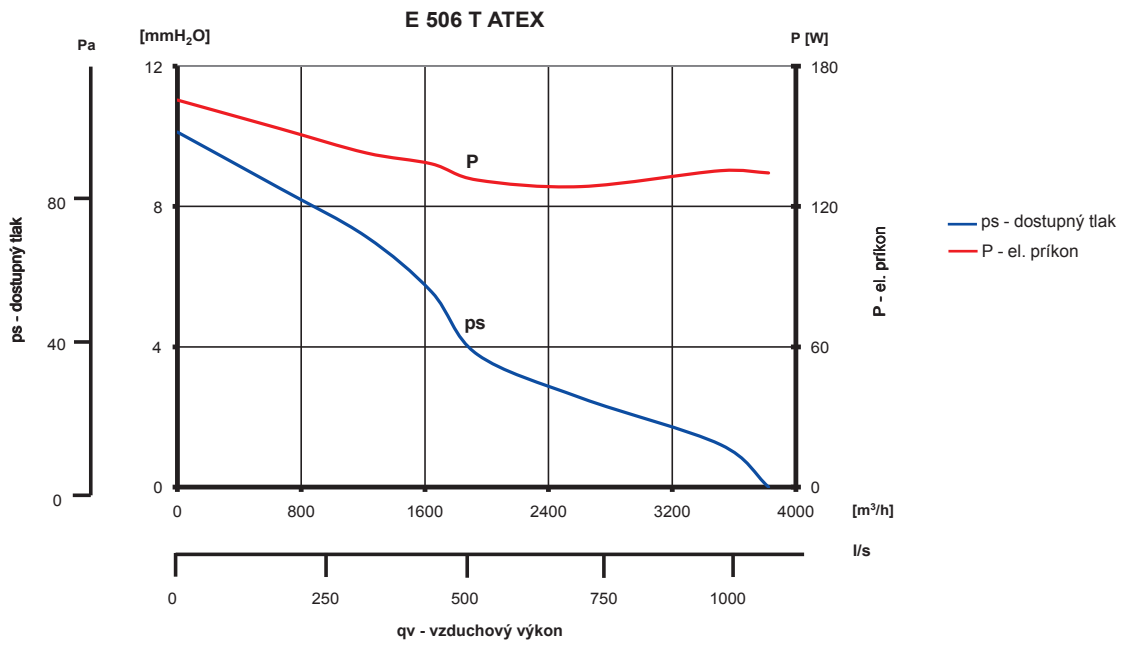
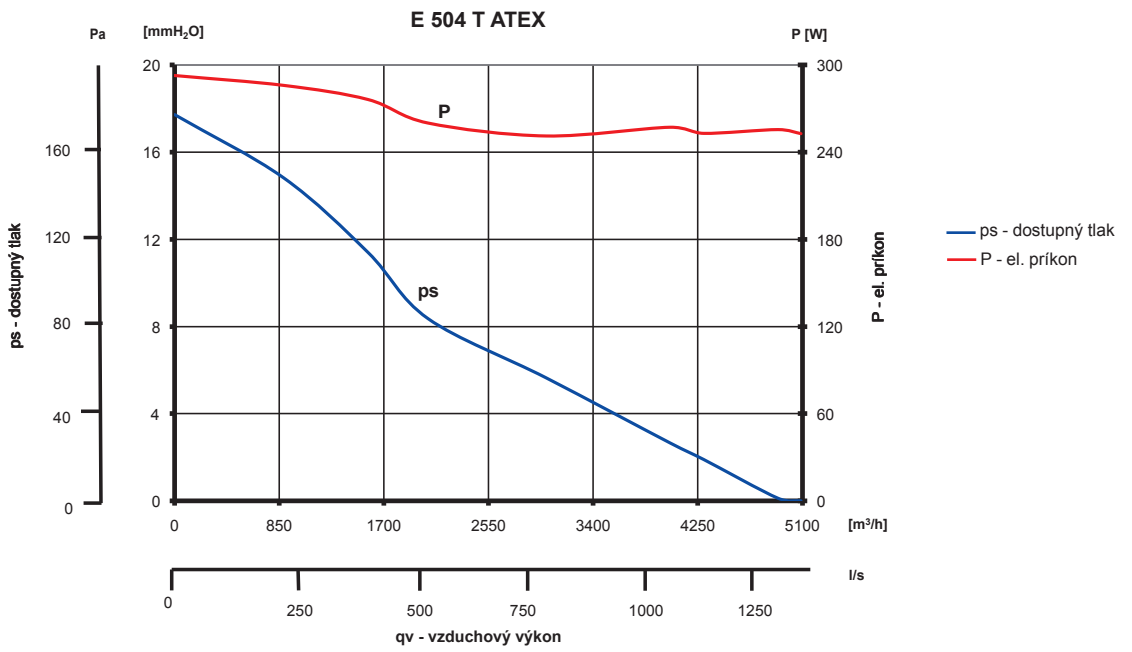

E 504 T ATEX

