

# RAD LINEO

## Potrubné ventilátory

Produkty radu LINEO sú vybavené viac otáčkovými indukčnými motormi.

NAJLEPŠÍ POMER MEDZI VÝKONOM,  
SPOTREBOU A HLUKOM.



# JEDNODUCHÁ A FLEXIBILNÁ INŠTALÁCIA

## VLASTNOSTI A VÝHODY

- 26 modelov s pripojením na potrubie s priemerom 100 mm až 315 mm, z toho 18 modelov s AC motorom a 8 modelov s EC motorom.
- S alebo bez časovača (dobehu).
- Flexibilita a jednoduchosť inštalácie, ideálne na dosiahnutie špecifických požiadaviek na výkon a spotrebu s ohľadom na náklady



# jednoduchá ÚDRŽBA

EL. KRABICA  
Pripojenie el. napájania  
/ umiestnenie riadiacej  
dosky

NASÁVACÍ OTVOR  
Pripojenie na potrubie



DIVERGENTNÝ ELEMENT  
Slúži na zvýšenie výkonových  
parametrov vrtule

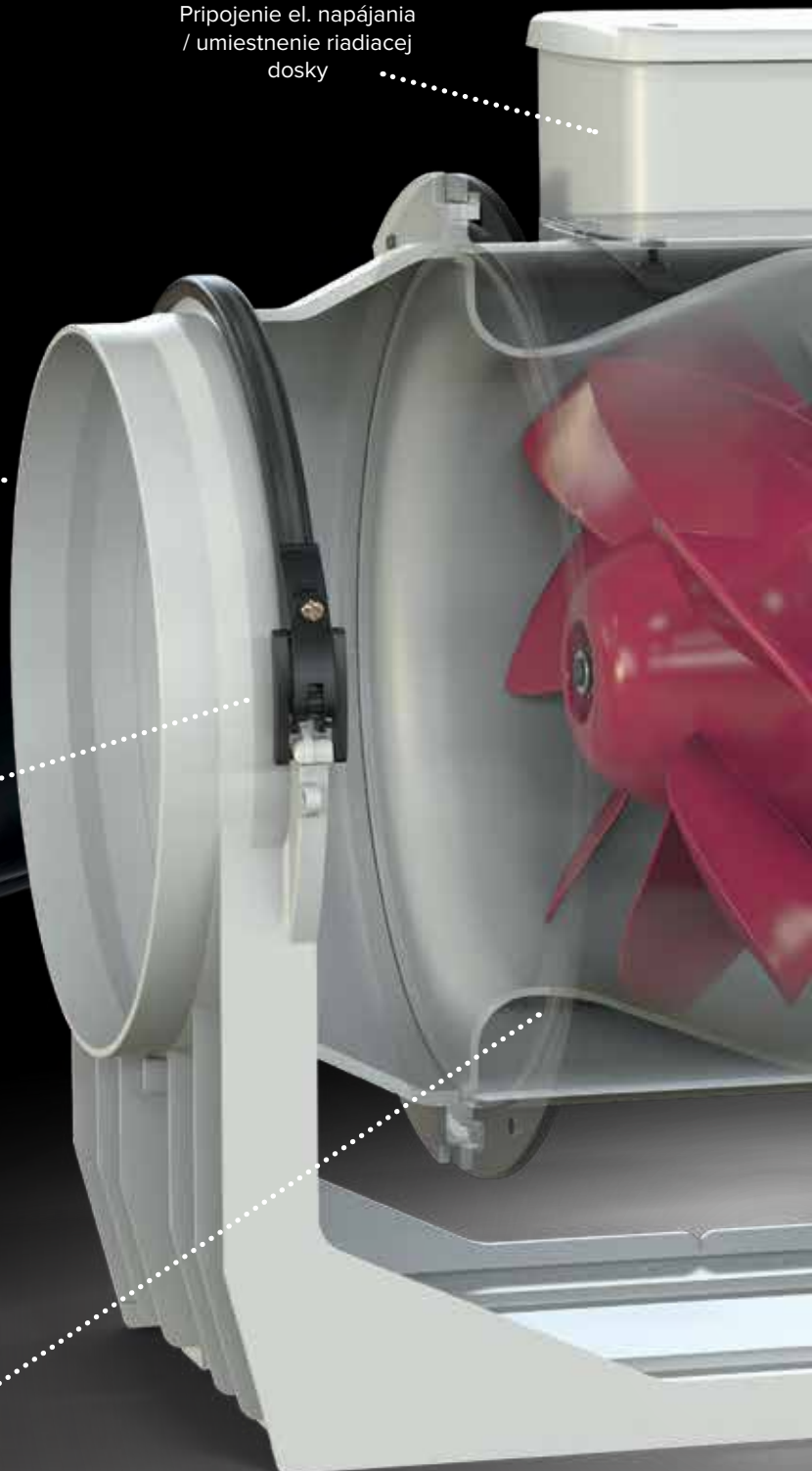

NOVÉ

RAD LINEO  
Potrubné ventilátory



### VRTUĽA

Navrhnutá pre dosiahnutie vyššej účinnosti a splnenie ErP

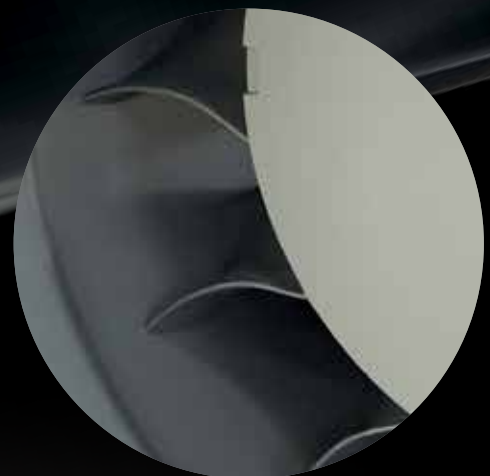
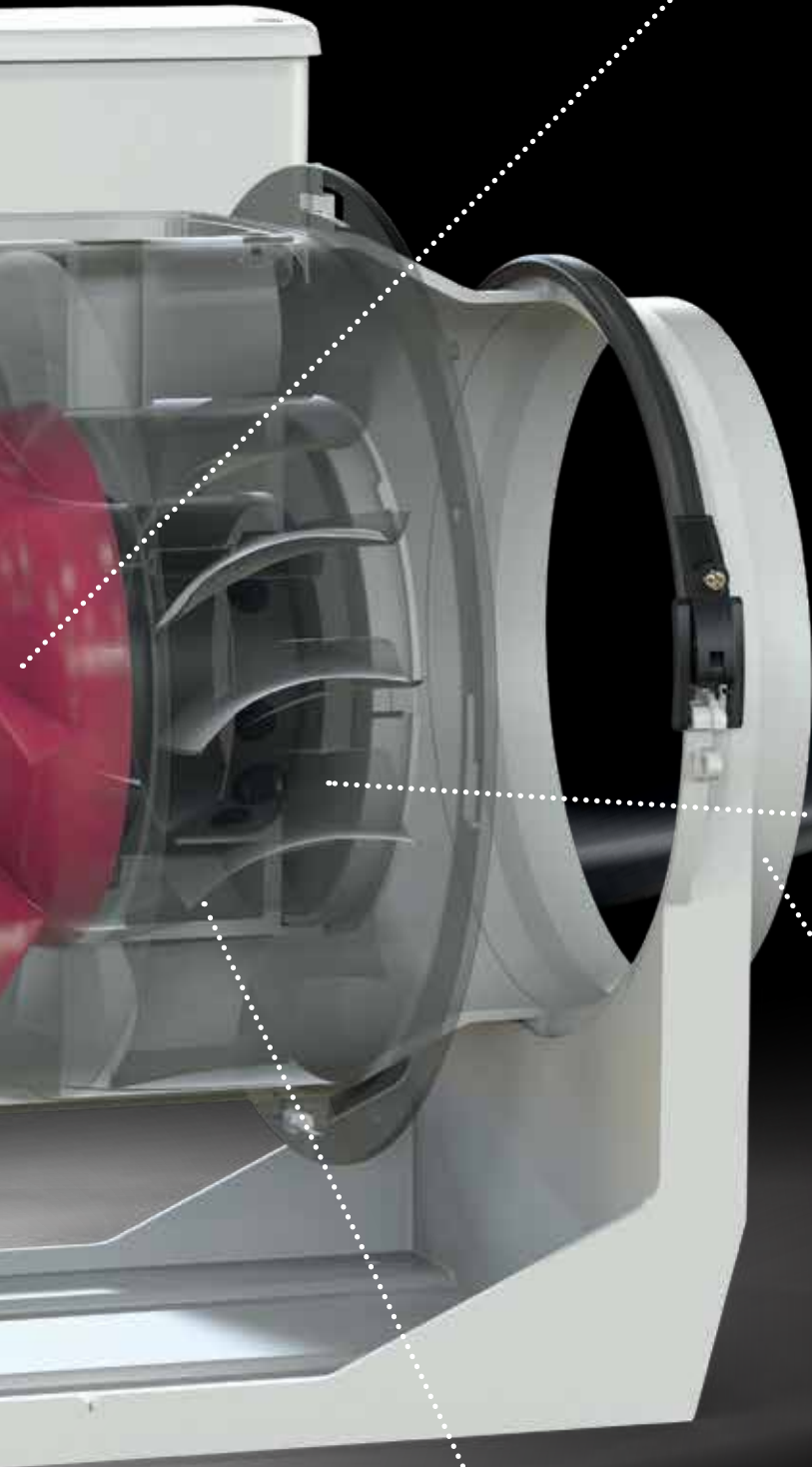

VÝFUKOVÝ OTVOR  
Pripojenie na potrubie

### USMERŇOVAČ PRIETOKU

Navrhovaný spolu s vrtuľou, na usmernenie prietoku a minimalizáciu turbulencií za vrtuľou

**TECHNICKÉ A VÝKONOVÉ ÚDAJE - LINEO**

Modely	Kód	El. napájanie 1~/50Hz (V)	El. príkon min/max (W)	El. prúd min/max (A)	Otáčky min/max (ot/min)	Vzduch. výkon min/max (m <sup>3</sup> /h)	Výtlak min/max (Pa)	Ak. tlak Lp min/max dB(A)*	Krytie**	Max. teplota (°C)	Hmotnosť (kg)
LINEO 100	17144	220-240	20	0.09	1520	180	127.5	30.7	IP44	60	1.8
LINEO 100 T	17185		23	0.11	2030	255	161.9	39.4			
LINEO 100 Q	17143	220-240	12	0.05	1860	155	63.8	29.4	IP44	60	1.8
LINEO 100 Q T	17184		15	0.9	2450	200	73.6	37.9			
LINEO 125	17145	220-240	25	0.11	1570	250	127.5	33.9	IP44	60	1.8
LINEO 125 T	17186		33	0.15	2140	365	166.8	43			
LINEO 150	17146	220-240	40	0.18	1580	385	206	41.4	IP44	60	2.5
LINEO 150 T	17187		58	0.26	2100	550	264.9	50.5			
LINEO 160	17147	220-240	40	0.18	1580	385	206	41.7	IP44	60	2.8
LINEO 160 T	17188		58	0.26	2100	550	264.9	50.8			
LINEO 200 Q	17148	220-240	45	0.22	1780	700	127.5	39.6	IP44	60	4.3
LINEO 200 Q T	17189		75	0.37	2740	950	284.5	49.0			
LINEO 250 Q	17149	220-240	85	0.40	1850	720	333.5	49.1	IP44	60	5.9
LINEO 250 Q T	17197		110	0.50	2550	990	519.9	56.2			

Modely	Kód	El. napájanie 1~/50Hz (V)	El. príkon min/str/max (W)	El. prúd min/str/max (A)	Otáčky min/str/max (ot/min)	Vzduch. výkon min/str/max (m <sup>3</sup> /h)	Výtlak min/str/max (Pa)	Krytie**	Max. teplota (°C)	Hmotnosť (kg)
<b>NOVÉ</b> LINEO 200	17180	220 - 240	80	0.34	1925	815	210.9	IPX5	50	4,9
<b>NOVÉ</b> LINEO 200 T	17177		95	0.42	2450	1025	267.7			
<b>NOVÉ</b> LINEO 250	17181	220 - 240	90	0.41	1500	725	136.5	IPX5	50	5,3
			120	0.54	2240	1145	284.4			
			145	0.63	2730	1440	364.8			
<b>NOVÉ</b> LINEO 315	17182	220 - 240	190	1.14	1770	1590	265.8	IPX5	50	9,5
			260	1.57	2300	2115	413.9			
			360	1.60	2690	2590	543.3			

\* kalkulované vo voľnom priestore vo vzdialenosti 3m

\*\* krytie platné pre ventilátory napojené na potrubie z oboch strán

**HLUČNOSŤ - LINEO 200 - 250 - 315**

Modely	Kód	NASÁVANIE			AKUSTICKÝ VÝKON Lw dB (A)			DO OKOLIA		
		min	str.	max	min	str.	max	min	str.	max
LINEO 200	17180	80	86.4	89.5	78.6	74.9	88.2	57.4	63.7	67.5
LINEO 200 T	17177									
LINEO 250	17181	73.6	83.3	88.2	72.2	81.7	86.4	52.4	60	64
LINEO 315	17182	82.6	88.7	92	82	88.2	91.8	60.1	66.3	69.5

Modely	Kód	NASÁVANIE			AKUSTICKÝ TLAK LP dB(A)***			DO OKOLIA		
		min	str.	max	min	str.	max	min	str.	max
LINEO 200	17180	62.5	68.8	72	61	67.4	70.7	36.9	43.1	46.9
LINEO 200 T	17177									
LINEO 250	17181	56.1	65.8	70.7	54.6	64.2	68.8	31.9	39.5	43.5
LINEO 315	17182	65	71.1	74.5	64.5	70.6	74.2	39.6	45.8	49

\*\*\* kalkulované vo voľnom priestore vo vzdialenosti 3m

## ROZMERY - LINEO

Modely	Kód	A	B	C	Ø D	E	F	G	H	L	Ø M	N
LINEO 100	17144	188.5	211	303	96	101.5	189	90	60	80	5.5	-
LINEO 100 T	17185	188.5	211	303	96	101.5	189	90	60	80	5.5	-
LINEO 100 Q	17143	156	174	231	96	82	152	95	51.5	47.5	4.5	-
LINEO 100 Q T	17184	156	174	231	96	82	152	95	51.5	47.5	5.5	-
LINEO 125	17145	188.5	211	258	122	101.5	189	90	60	80	5.5	-
LINEO 125 T	17186	188.5	211	258	122	101.5	189	90	60	80	5.5	-
LINEO 150	17146	214.5	234	294	146	112.5	212	110	60	80	5.5	-
LINEO 150 T	17187	214.5	234	294	146	112.5	212	110	60	80	5.5	-
LINEO 160	17147	214.5	234	272.5	156	112.5	212	110	60	80	5.5	-
LINEO 160 T	17147	214.5	234	272.5	156	112.5	212	110	60	80	5.5	-
LINEO 200	17180	270	373	396	194.5	195	330	190	120	155	5.5	-
LINEO 200 T	17177	270	373	396	194.5	195	330	190	120	155	5.5	280
LINEO 200 Q	17148	234.5	266	300	196	125.5	235	140	94	100	5.5	-
LINEO 200 Q T	17189	234.5	266	300	196	125.5	235	140	94	100	5.5	-
LINEO 250	17181	300	378	322	243	190	329	200	70	170	5.5	174.5
LINEO 250 Q	17149	300	322	385	247	152.5	292	176.5	140	145	5.5	-
LINEO 250 Q T	17189	300	322	385	247	152.5	292	176.5	140	145	5.5	174.5
LINEO 315	17182	373	446	420	307	224	398	309	110	255	8.5	259.5

## VERZIA A

LINEO 100 - LINEO 100 T - LINEO 125 - LINEO 125 T - LINEO 150 - LINEO 150 T  
LINEO 160 - LINEO 160 T - LINEO 200 Q - LINEO 200 Q T - LINEO 250 Q - LINEO 250 Q T

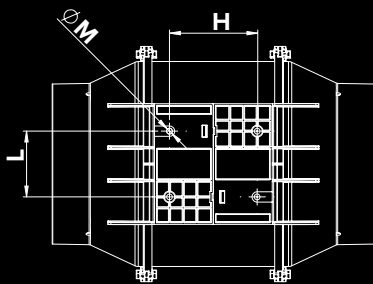

## VERZIA B

LINEO 100 Q  
LINEO Q T

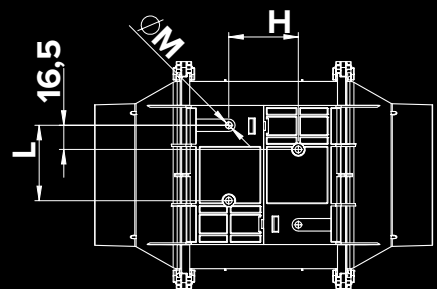

## VERZIA C

LINEO 200 - LINEO 200 T - LINEO 250 - LINEO 315

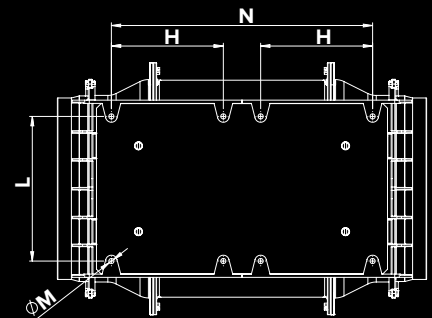
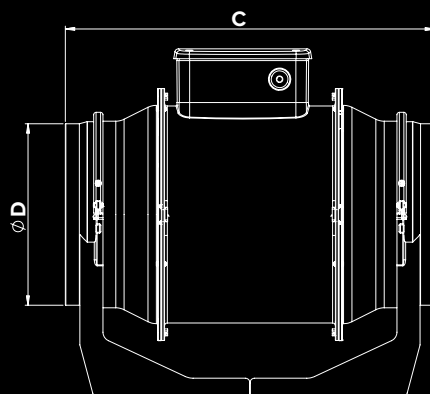
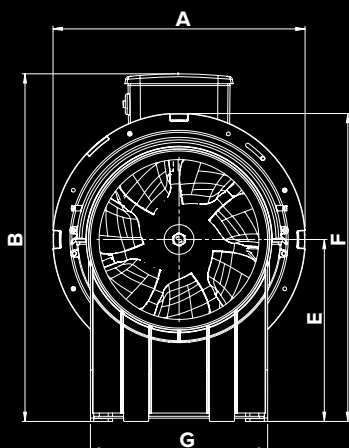



## TLAKOVO-VÝKONOVÉ KRIVKY - LINEO

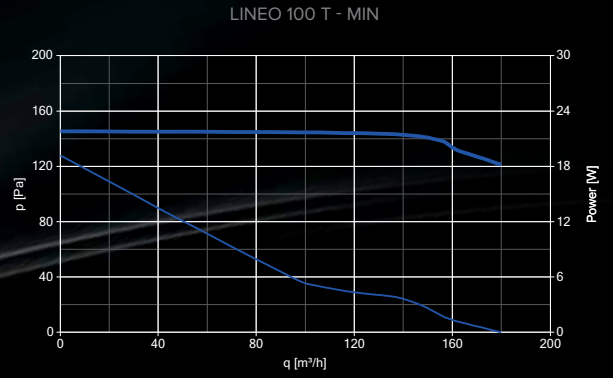
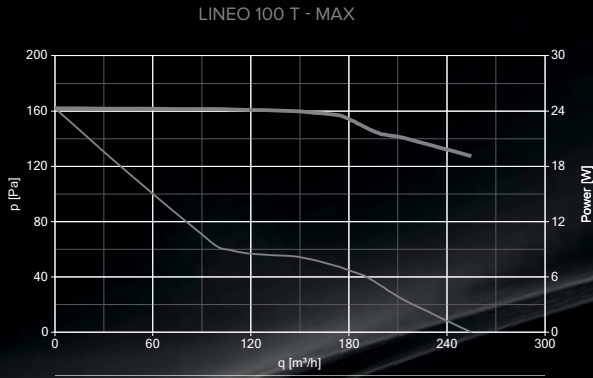
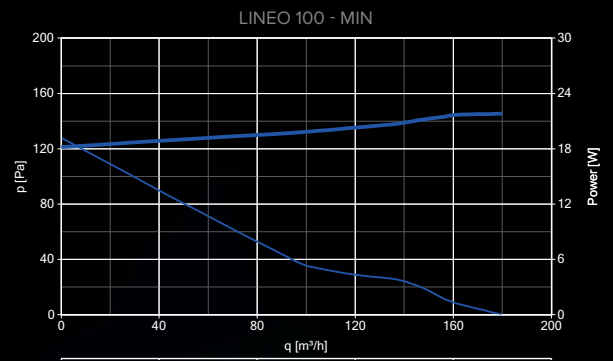
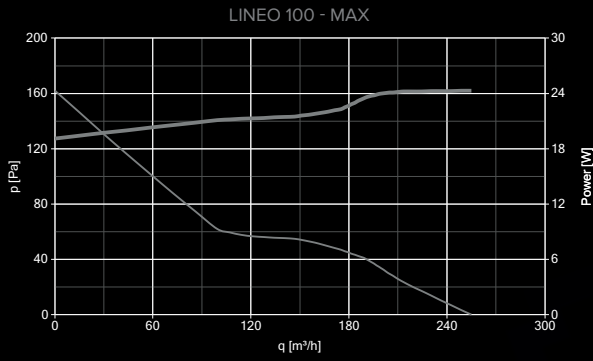

EL. PRÍKON [W]  
 — max  
 — min

VÝKON  
 — max  
 — min

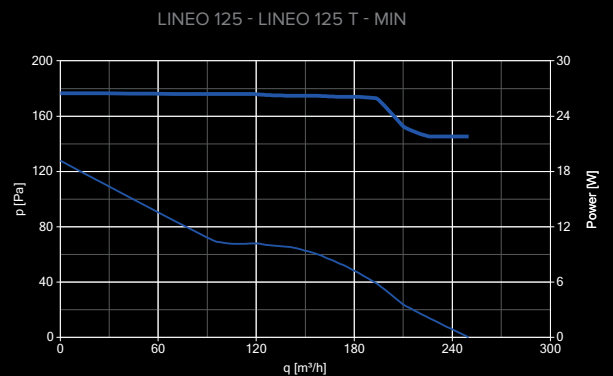
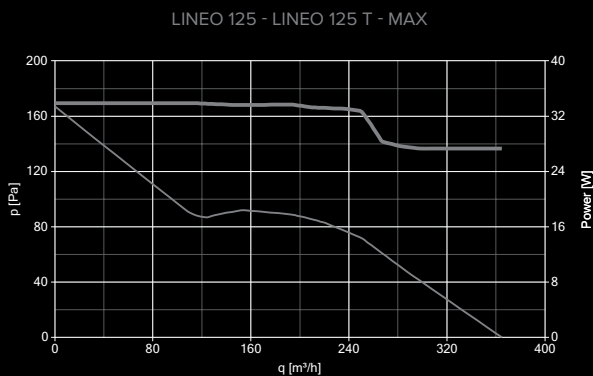
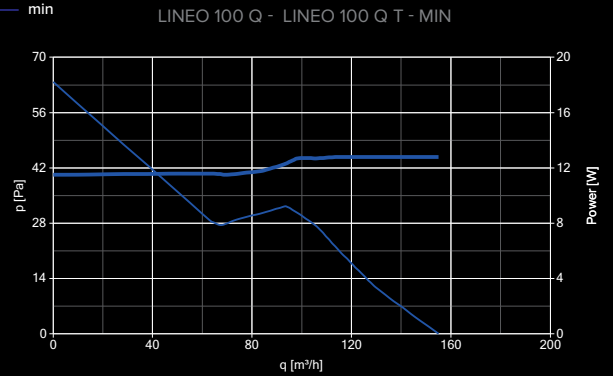
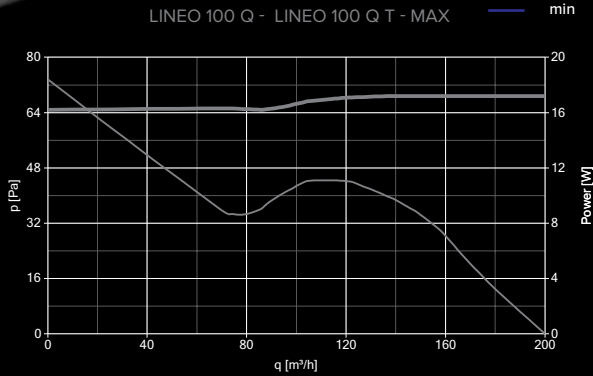

TLAKOVO-VÝKONOVÉ KRIVKY - LINEO

LINEO 150 - LINEO 150 T - MAX

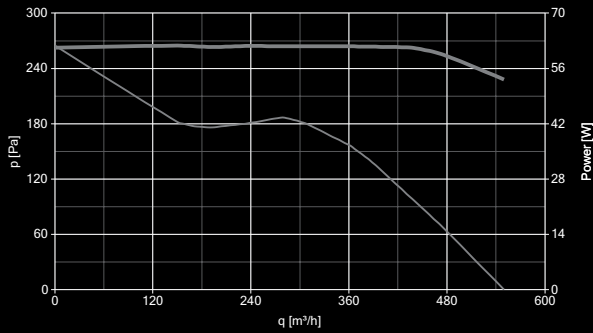

LINEO 150 - LINEO 150 T - MIN

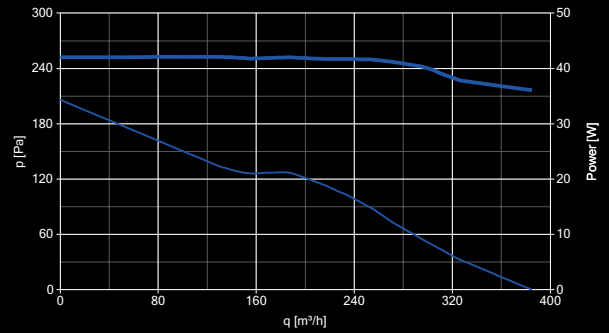

LINEO 160 - LINEO 160 T - MAX

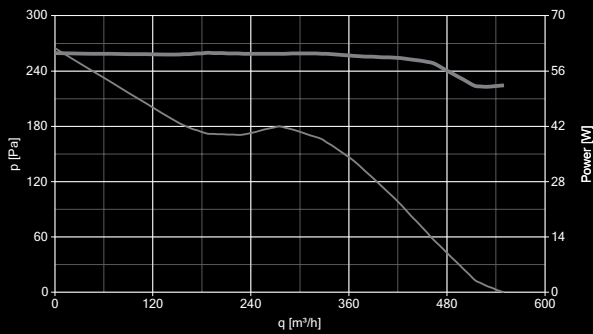

LINEO 160 - LINEO 160 T - MIN

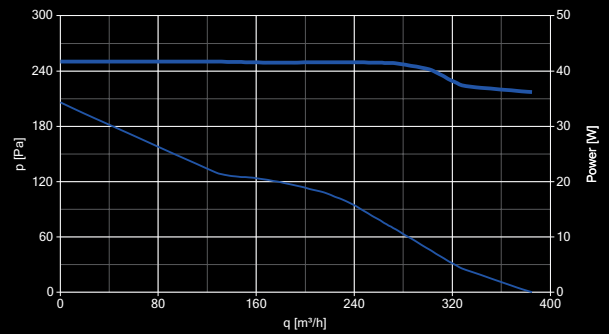

EL. PRÍKON  
— max  
— min

VÝKON  
— max  
— min

LINEO 200 Q - LINEO 200 Q T - MAX

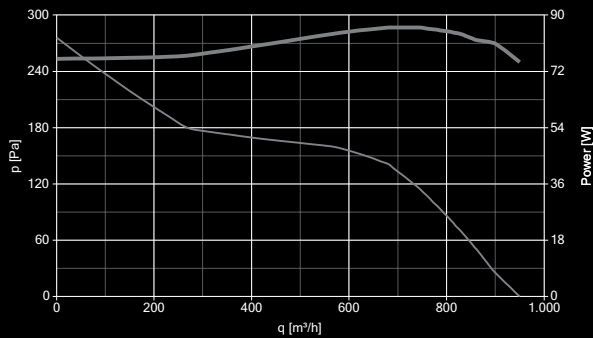

LINEO 200 Q - LINEO 200 Q T MIN

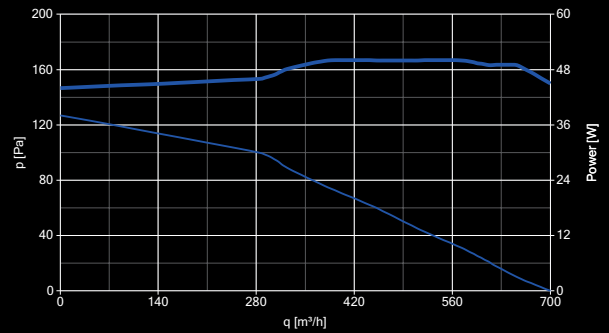

LINEO 250 Q - LINEO 250 Q T - MAX

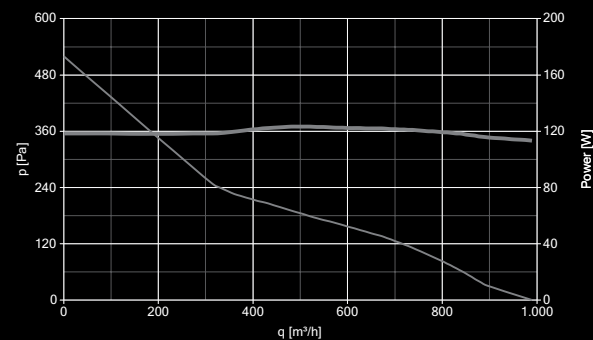

LINEO 250 Q - LINEO 250 Q T - MAX

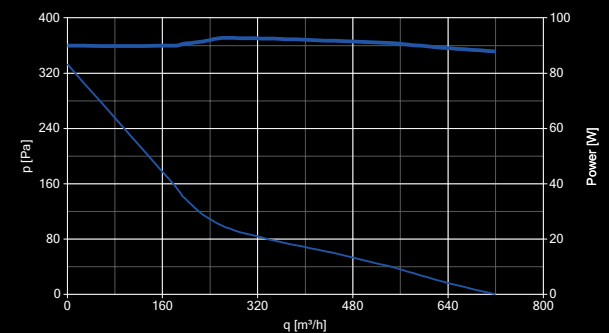





## TLAKOVO-VÝKONOVÉ KRIVKY - LINEO

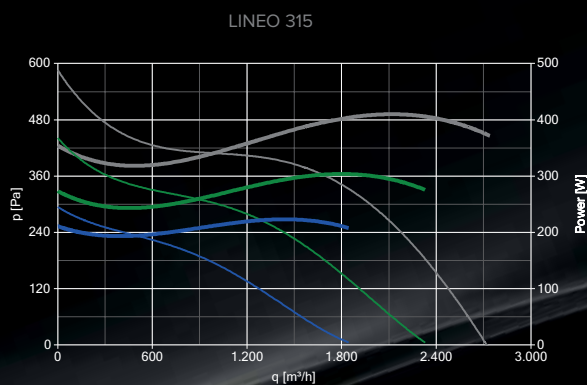
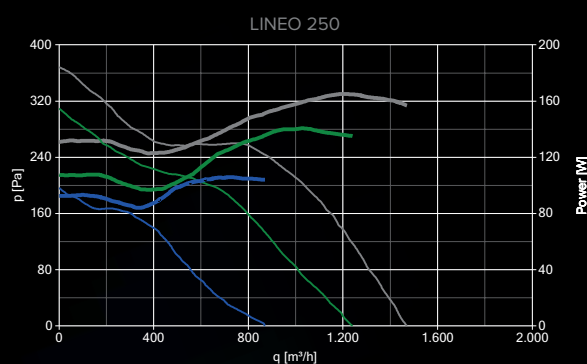
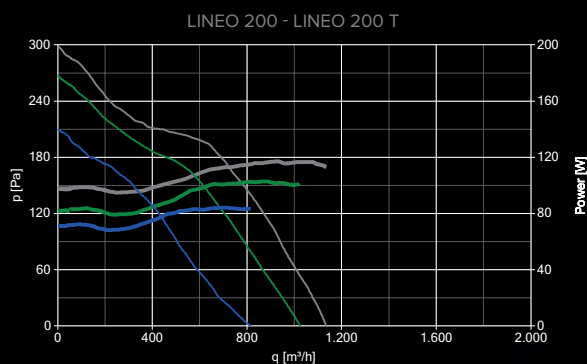

EL. PRÍKON [W]	VÝKON
— max	— max
— str.	— str.
— min	— min

NOVÉ

RAD LINEO

Potravné ventilátory s AC motorom

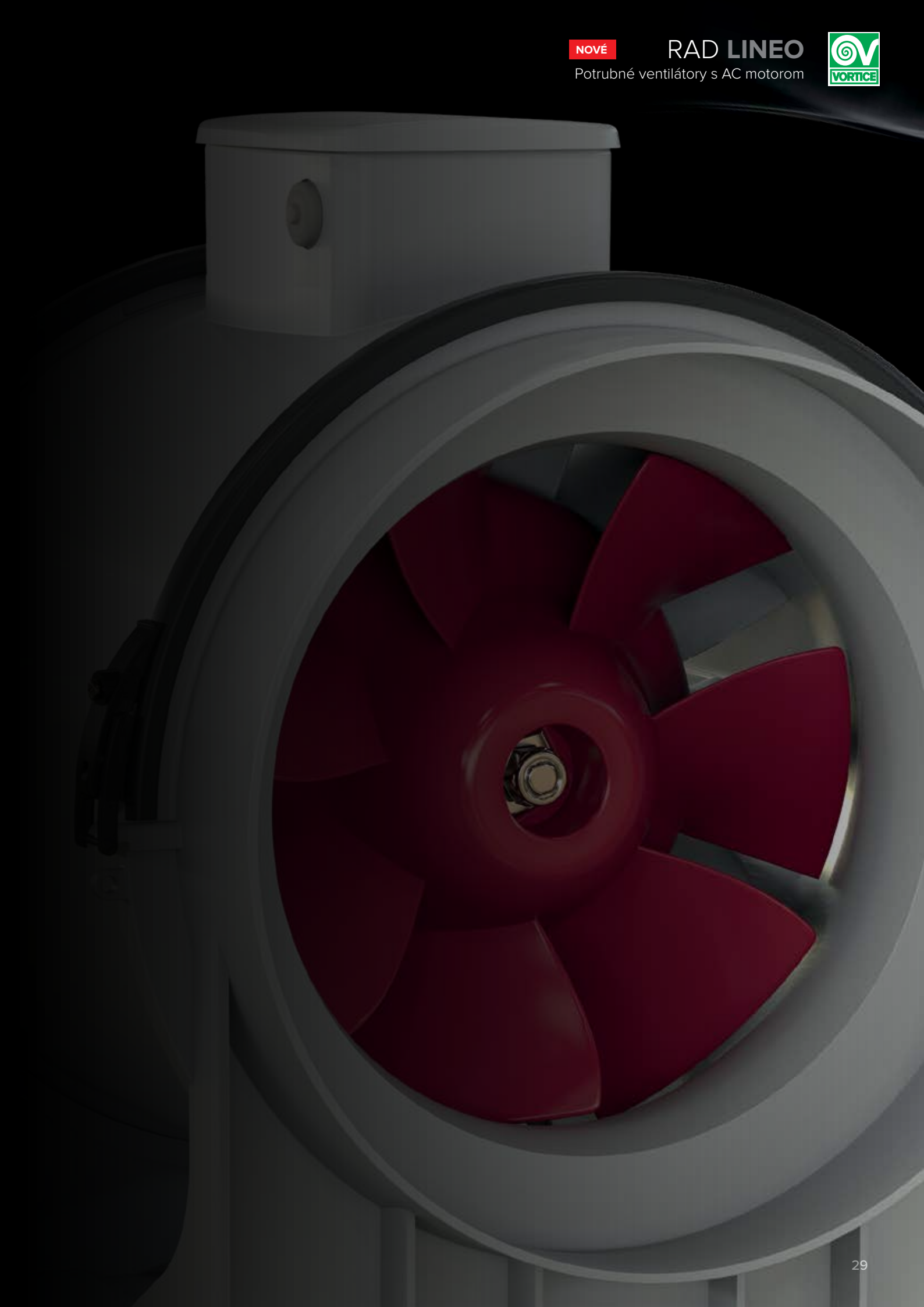

## TECHNICKÉ A VÝKONOVÉ ÚDAJE - LINEO ES

Modely	Kód	El. napájanie 1~/50Hz (V)	El. príkon 4V/6V/8V/10V (W)	El. prúd 4V/6V/8V/10V (A)	Otáčky 4V/6V/8V/10V (ot/min)	Vzduch. výkon 4V/6V/8V/10V (m³/h)	Výtlak 4V/6V/8V/10V (Pa)	Krytie*	Max. teplota (°C)	Hmotnosť (kg)
LINEO 100 ES	17159	220 - 240	6.5	0.07	1070	140	36.3	IP45	60	2.3
			8.7	0.09	1345	175	59.8			
			16	0.15	1900	250	111.8			
			20	0.20	2220	305	258.9			
LINEO 100 Q ES	17158	220 - 240	4.5	0.05	900	60	8.8	IP45	60	1.8
			5.5	0.06	1235	80	16.7			
			9	0.08	2070	145	42.2			
			19	0.18	3230	235	96.1			
LINEO 125 ES	17178	220 - 240	7	0.07	1090	170	37.3	IP45	60	2.2
			10	0.10	1395	220	63.7			
			18	0.17	1940	315	115.7			
			25	0.25	2270	370	296.2			
LINEO 150 ES	17179	220 - 240	11	0.10	1260	290	83.4	IP45	60	2.6
			17	0.16	1595	370	135.3			
			34	0.30	2125	500	222.6			
			55	0.50	2480	590	433.5			
LINEO 160 ES	17183	220 - 240	12	0.11	1305	300	9	IP45	60	2.7
			19	0.17	1645	385	145.1			
			37	0.33	2165	510	230.5			
			60	0.55	2625	630	462.9			
NOVÉ LINEO 200 ES	17167	220 - 240	15.8	0.19	1380	560	90.2	IP45	50	4.6
			25.7	0.28	1700	700	141.2			
			52.8	0.53	2220	920	235.4			
			90	0.80	2680	1100	342.4			
NOVÉ LINEO 250 ES	17168	220 - 240	20	0.17	2270	755	107.9	IP45	50	5
			35	0.28	1695	935	165.7			
			75	0.61	1370	1235	283.4			
			126	1.00	2680	1475	396.2			
NOVÉ LINEO 315 ES	17169	220 - 240	45	0.37	1300	1415	143.2	IP45	50	9.2
			75	0.63	1600	1740	214.8			
			170	1.32	2130	2320	378.6			
			230	1.75	2370	2625	421.7			

\* krytie platné pre ventilátory napojené na potrubie z oboch strán

## HLUČNOSŤ - LINEO ES

### AKUSTICKÝ VÝKON Lw dB (A)

Modely	Kód	NASÁVANIE				VÝFUK				DO OKOLIA			
		4V	6V	8V	10V	4V	6V	8V	10V	4V	6V	8V	10V
LINEO 100 ES	17159	63.3	69.4	78.2	82.6	62.1	68.4	77.5	82	35.5	39.5	47.8	52.3
LINEO 100 Q ES	17158	57.8	64.9	75.1	85.7	54.9	64.9	73.5	85.7	35.1	37.4	47.5	56.6
LINEO 125 ES	17178	64.1	68.2	76.7	81.4	63.6	68.6	77.5	81.5	36.8	40.5	48.8	52.2
LINEO 150 ES	17179	67.9	74.6	82.1	87.9	69.6	75.2	82.1	86.4	41.5	47.8	56.1	62.5
LINEO 160 ES	17183	68.4	76.4	83.1	87.5	69.1	76	82.8	86.9	42.4	49.4	57	62.3
LINEO 200 ES	17167	78.5	83.9	86.9	89.4	77.5	82.9	85.4	88.4	55.6	60.4	62.8	65
LINEO 250 ES	17168	74.2	79.1	85.1	88.9	74.4	79.2	84.9	88.5	49.5	54.3	61.4	64
LINEO 315 ES	17169	83.1	88	90.7	92.8	80.8	88.2	88.8	90	63	64.6	65.3	68.1

### AKUSTICKÝ TLAK Lp dB(A)\*\*

Modely	Kód	NASÁVANIE				VÝFUK				DO OKOLIA			
		4V	6V	8V	10V	4V	6V	8V	10V	4V	6V	8V	10V
LINEO 100 ES	17159	45.8	51.9	60.7	65.1	44.6	50.9	59.9	64.4	15	18.9	27.2	31.8
LINEO 100 Q ES	17158	40.2	47.3	57.6	68.2	37.3	47.4	56	68.1	14.6	16.9	27	36.1
LINEO 125 ES	17178	46.6	50.6	59.1	63.9	46	51.1	60	64	16.2	20	28.3	31.6
LINEO 150 ES	17179	50.4	57.1	64.6	70.3	52.1	57.7	64.5	68.9	21	27.2	35.5	41.9
LINEO 160 ES	17183	50.9	58.9	65.6	70	51.5	58.5	65.6	69.3	21.9	28.9	36.5	41.8
LINEO 200 ES	17167	60.9	66.4	69.4	71.9	60	65.3	67.9	70.8	35.1	39.9	42.3	44.5
LINEO 250 ES	17168	56.7	61.5	67.6	71.3	56.9	61.6	67.3	71	29	33.7	40.9	43.4
LINEO 315 ES	17169	65.6	70.4	73.2	75.3	63.3	70.6	71.2	72.4	42.5	44	44.8	47.5

\*\* kalkulované vo voľnom priestore vo vzdialenosti 3m

## ROZMERY - LINEO ES

Modely	Kód	A	B	C	Ø D	E	F	G	H	L	Ø M	N
LINEO 100 ES	17159	188.5	240	303	96	101.5	189	90	60	80	5.5	-
LINEO 100 Q ES	17158	156	205	231	96	82	152	95	51.5	47.5	4.5	-
LINEO 125 ES	17178	188.5	240	258	122	101.5	189	90	60	80	5.5	-
LINEO 150 ES	17179	214.5	265	294	146	112.5	212	110	60	80	5.5	-
LINEO 160 ES	17183	214.5	265	272.5	156	112.5	212	110	60	80	5.5	-
LINEO 200 ES	17167	270	372.5	396	194.5	195	330	190	120	155	5.5	280
LINEO 250 ES	17168	300	377.5	322	243	190	329	200	70	170	6.5	174.5
LINEO 315 ES	17169	373	506	420	307	224	398	309	110	255	8.5	259.5

### VERZIA A

LINEO 100 ES - LINEO 125 ES  
LINEO 150 ES - LINEO 160 ES

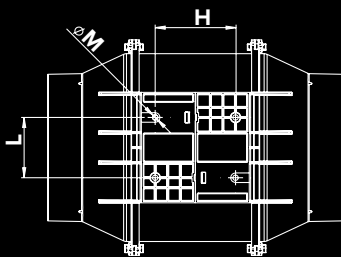

### VERZIA B

LINEO 100 Q ES

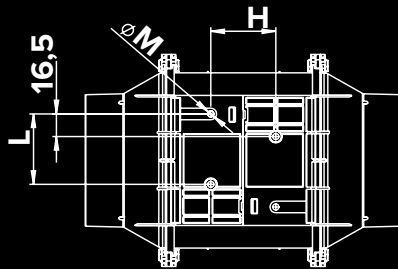

### VERZIA C

LINEO 200 ES - LINEO 250 ES - LINEO 315 ES

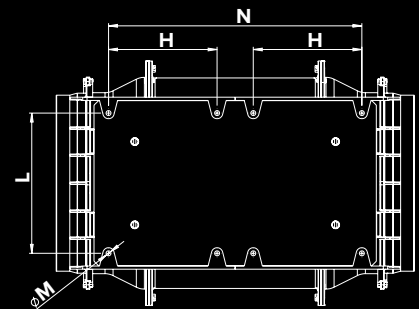
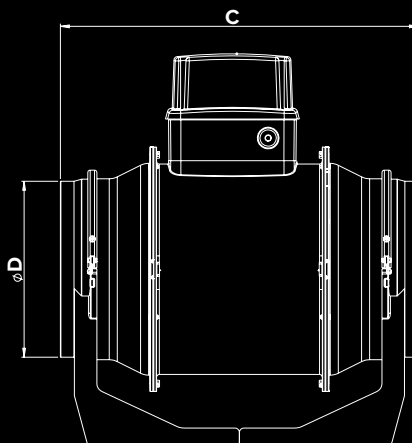
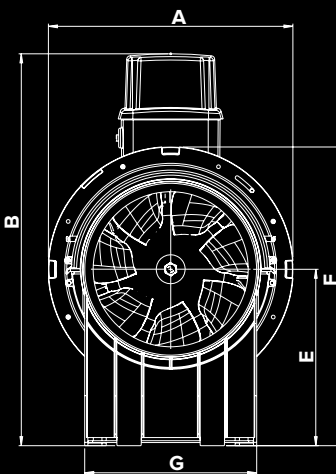

## TLAKOVO-VÝKONOVÉ KRIVKY - LINEO ES

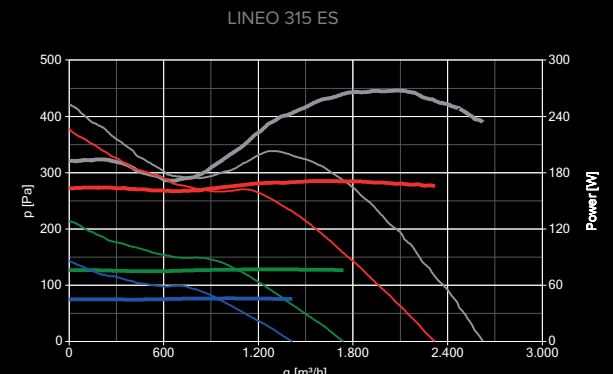
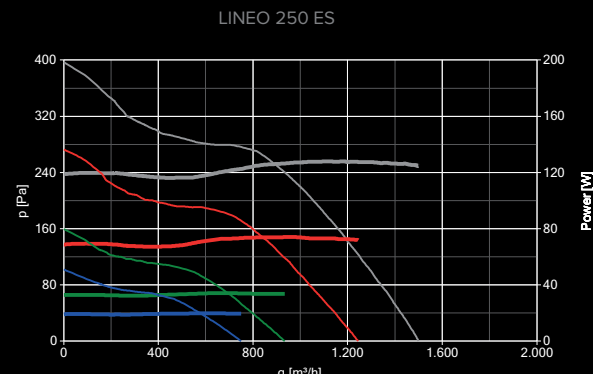
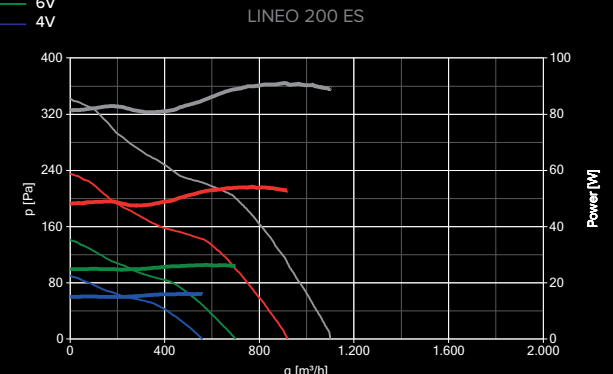
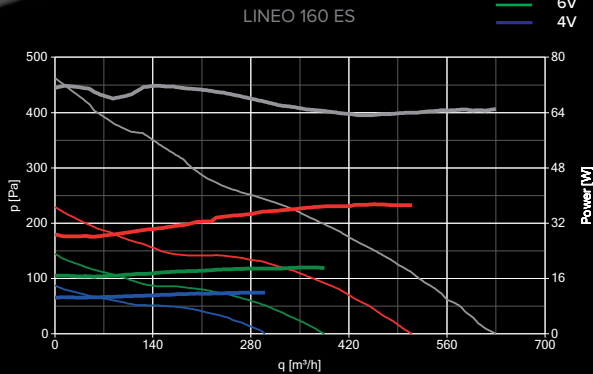
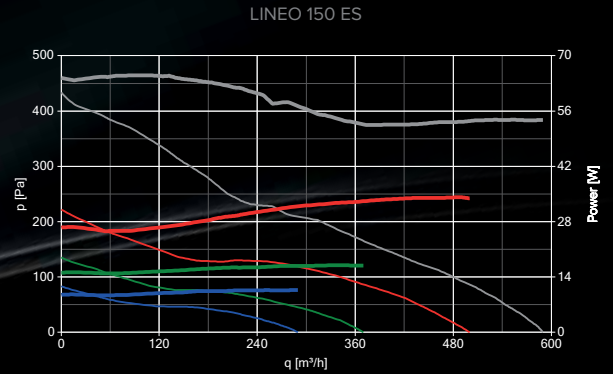
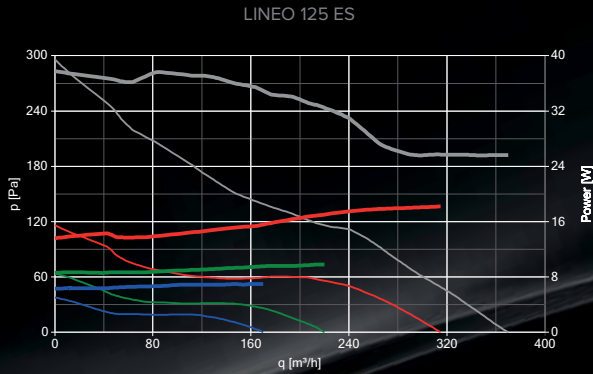
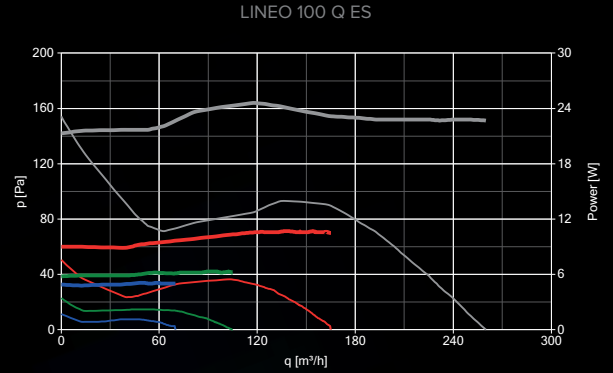
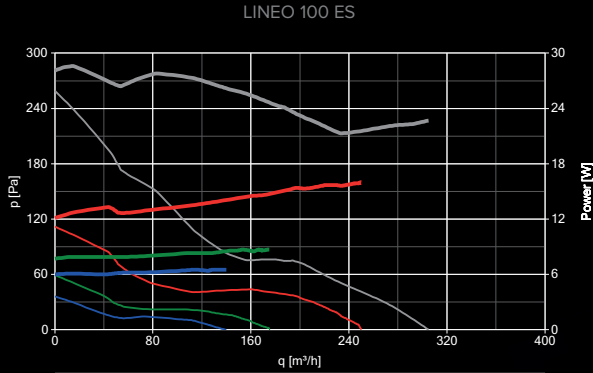







EL. PRÍKON [W]

- 10V
- 8V
- 6V
- 4V

VÝKON

- 10V
- 8V
- 6V
- 4V

## REGULÁTORY - LINEO

MODELY	POPIS	KÓD	KOMPATIBILITA
	<b>C5 0.5</b> - (5-STUPŇOVÁ REGULÁCIA)	12987	17180
	<b>C 1.5</b> (PLYNULÁ REGULÁCIA OTÁČOK, MAX 1.5 A)	12966	17180
	<b>C 2.5</b> (PLYNULÁ REGULÁCIA OTÁČOK, MAX 2.5 A)	12967	17181 - 17182
	<b>POT-IT</b> - POTENCIOMETER 0-10V A PREPÍNAČ ZAP/VYP (VYŽADUJE KRABIČKU UNI 503)	12826	17158 - 17159 - 17179 - 17183 - 17187 17167 - 17168 - 17169
	<b>POT</b> - POTENCIOMETER 0-10V (VYŽADUJE KRABIČKU DIN)	12828	17158 - 17159 - 17179 - 17183 - 17187 17167 - 17168 - 17169
	<b>TRIO-LINEO 503</b> - (3-STUPŇOVÁ REGULÁCIA)	12891	17181 - 17177 - 17182
	<b>DUO</b> - VYPÍNAČ A PREPÍNAČ OTÁČOK	22914	17144 - 17185 - 17143 - 17184 - 17145 17186 - 17146 - 17187 - 17147 - 1718 17148 - 17189 - 17149 - 17197
	<b>C TEMP</b> - SNÍMAČ TEPLoty	12992	VŠETKY MODELY
	<b>C SMOKE</b> - SNÍMAČ PACHOV	12993	VŠETKY MODELY
	<b>C HCS</b> - SNÍMAČ VLHKOSTI	12994	VŠETKY MODELY
	<b>C PIR</b> - SNÍMAČ POHYBU	12998	VŠETKY MODELY
	<b>C TIMER</b> - ČASOVAČ	12999	VŠETKY MODELY

## VOLITEĽNÉ PRÍSLUŠENSTVO - LINEO

MODELY	POPIS	KÓD	KOMPATIBILITA	
	<b>LINEO-C</b> - SADA PRE MONTÁŽ 2 VENTILÁTOROV ZA SEBOU	100	22584	17159 - 17158
		125	22585	17178
		150	22586	17179
		160	22587	17183
		100	22577	17159 - 17158
	<b>LINEO-PF</b> - SADA PRE MONTÁŽ 2 VENTILÁTOROV VEDĽA SEBA	125	22578	17178
		150	22579	17179
		160	22581	17183
		17143 - 17184 - 17144 - 17185 - 17159 17158 - 17145 - 17186 - 17178 - 17146 17187 - 17179 - 17147 - 17188 - 17183 17148 - 17189 - 17180 - 17177 - 17167		
	<b>LINEO-SF 500</b> - MONTÁŽNA PLATŇA	22593		
	<b>LINEO-SF 700</b> - MONTÁŽNA PLATŇA	22594	17149 - 17197 - 17168 - 17169	
	<b>LINEO-G</b> - OCHRANNÁ MREŽKA	100	22701	17143 - 17184 - 17144 17185 - 17159 - 17158
		125	22702	17145 - 17186 - 17178
		150	22703	17146 - 17187 - 17179
		160	22704	17147 - 17188 - 17183
		200	22705	17148 - 17189 - 17180 - 17177 - 17167
		250	22706	17149 - 17197 - 17168
		315	22707	17169