



Dantherm[®]
CLIMATE SOLUTIONS

2023

ENERGY-EFFICIENT SOLUTIONS

FOR RESIDENTIAL VENTILATION

DANTHERMGROUP

DANTHERM GROUP





About the Dantherm Group

Dantherm Group is a European leader in portable and installed climate control solutions for a wide range of industries and uses. Based on the heritage of the variety of brands we own, our climate control experts build and manufacture hundreds of thousands of exceptional heating, cooling, dehumidification, air cleaning and ventilation units in our own factories in Europe every year. All of them are designed to create healthy and comfortable climate surroundings in a sustainable, energy-efficient and cost-effective way.

Why partner with us

- European design quality
- Experts in climate control
- Extensive range of solutions

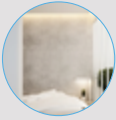
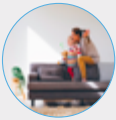
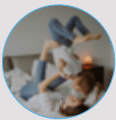
INDEX

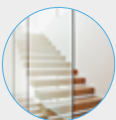
Product	Name	Page
	INTRODUCTION	5
	WALL-MOUNTED	10
	CEILING- AND WALL-MOUNTED	57
	ATTIC- AND WAAL-MOUNTED	83
	ACCESSORIES	102
	CONTROLS	118

WHY CHOOSE OUR RESIDENTIAL VENTILATION PRODUCTS?



CHOOSING THE BEST SOLUTION

Unique Dantherm products for residential ventilation for your home.



RESIDENTIAL VENTILATION SOLUTIONS

Balanced whole-house mechanical ventilation with heat recovery for private homes.



REMOTE CONTROL POSSIBLE

Dantherm residential ventilation units can be controlled using the Dantherm APP.



STAY COOL IN THE SUMMER

The automatic free-cooling features lets in cool night air on hot days to help maintain a comfortable temperature throughout the day.



KEEP HUMIDITY UNDER CONTROL

Optional enthalpy heat exchangers reuse heat and keep indoor air at the optimal humidity level summer and winter.



VERSATILE INSTALLATION OPTIONS

Designed for installation in standard cabinets, on walls or in ceilings, our range of units can be used for private homes and apartment buildings of any size.



REDUCE OPERATING COSTS

We focus on developing energy saving units.



CREATING A HEALTHY ENVIRONMENT

All Dantherm units use automatic demand-controlled ventilation that constantly monitors and measures the moisture content in the extracted air and then adjusts fan speed accordingly.



PROTECT THE ENVIRONMENT

Our development teams focus on reducing the carbon foot print by making our products as environmentally friendly as possible.



TECHNICAL SUPPORT AND AFTER-SALES CARE

Network of service agents and accredited technicians available from Dantherm Group Denmark, UK and Italy and through local distributors.

INTRODUCTION

A good indoor climate is inseparable from the ventilation of the home. Ventilation adds fresh air and removes the humidity released by residents through exhaling, doing laundry, cooking, bathing and more.

A typical family of four people generates around 10 litres of water vapour a day, so the home is subjected to a considerable amount of humidity if its ventilation is not able to replace the damp air with fresh air from outside. If the air change is inadequate, moisture accumulates in the home, increasing the risk of condensation building up on cold surfaces, which can lead to mould.

As we continue to build houses more and more airtight to keep in the heat, the need for mechanical ventilation increases. The natural ventilation through leaks and cracks in the building envelope is so minimal in modern buildings that it is necessary to use mechanical ventilation in order to comply with building regulation requirements on the supply of fresh outdoor air and to ensure a pleasant indoor climate.

Dantherm provides the ideal ventilation solution for private family houses, social housing, and private sector apartment blocks be they new-build or renovation projects.



INTRODUCTION

VENTILATION WITH HEAT RECOVERY

High efficiency, low power consumption and low-noise balanced ventilation solutions.

Highly efficient heat exchangers and fans

Dantherm manufactures highly efficient alu heat exchangers – lightweight counter-flow heat exchangers in aluminium that deliver up to 86% efficiency at a minimal pressure loss. We also use plastic exchangers, with thermal efficiency of up to 96%. The ventilation units come with energy-efficient EC fan motors that help reduce energy consumption.

Enthalpy helps in all seasons of the year

Dantherm's enthalpy ventilation units offer a number of unique advantages compared to other types of counter-flow heat exchangers. By transferring humidity from the extract air to the supply air, the enthalpy exchanger prevents drying out of the indoor climate during the winter. In the summer, it removes humidity from the supply air. This way, the enthalpy exchanger maintains an optimal indoor air humidity (40-60%) throughout the year, thereby avoiding drying out and humidity issues. Moreover, the enthalpy exchanger significantly reduces energy consumption because it recovers heat and humidity very efficiently.

Fans

Dantherm's units are equipped with the latest EC (Electromagnetic Commutation) fan motor technology, so they are fitted with modern motors and fan rotors offering the very best in air technology and electrical efficiency. Thanks to the EC technology the bearings are the only moving parts to produce resistance, and therefore the lifetime of these fans is approximately ten years. The fans are connected to the controller of the fan unit and powered by 230V, and the stepless fan speed is controlled by a 0-10 volt signal.



Healthy and comfortable indoor climate

Why choose Dantherm Residential Ventilation?

- Danish design and quality since 1958
- Vast experience within residential ventilation
- Energy-efficient solutions
- Units for mounting on walls, attics, ceilings, and suspended ceilings
- Versatile unit configuration with L/R switch
- Smartphone App available
- Automatic free cooling
- Easy installation and user-friendly operation
- Trained and experienced service team

Frost protection

The intelligent control system prevents the heat exchanger from icing up. Frost protection is automatically activated at low outdoor temperatures. In areas where the outdoor temperature is frequently lower than minus 3°C, preheating coils are recommended to heat the outdoor air before it enters the heat exchanger.

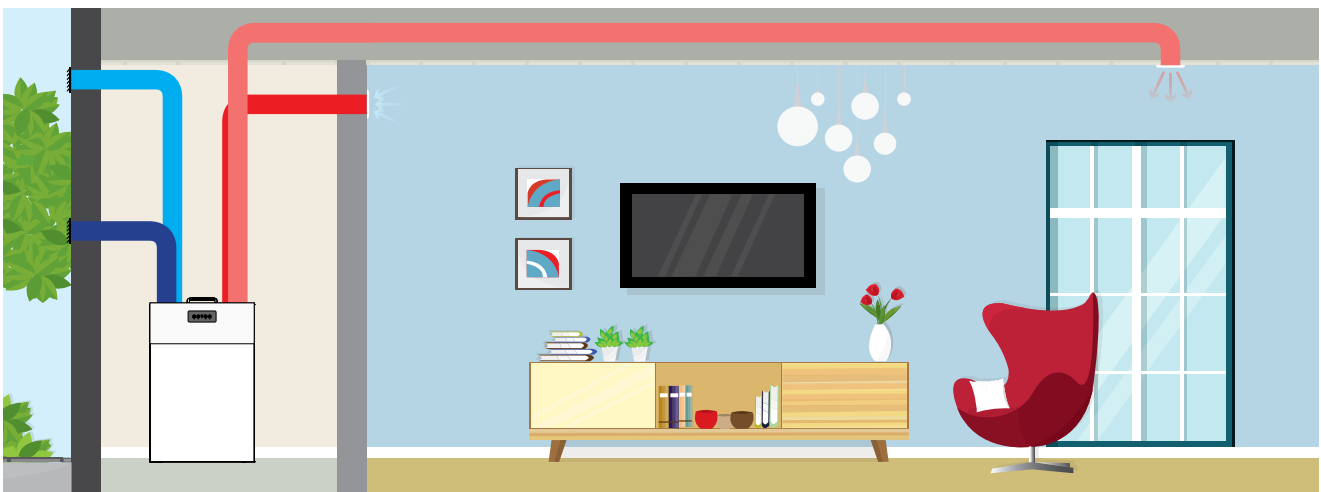

INTRODUCTION

VENTILATION WITH HEAT RECOVERY

Automatic and manual free cooling

Dantherm residential ventilation units have an inbuilt automatic bypass function to obtain 100% free cooling with outdoor air. The bypass opens and closes automatically depending on the extract air temperature readings and settings. Moreover, a manual bypass function can be activated whenever required, allowing the fresh outdoor air to move through the unit without passing through the heat exchanger. It is activated with one of the control interfaces – the built-in control panel, wireless remote control, wired control, the Dantherm App, or the Dantherm PC Tool. At outdoor temperatures below 9°C, the bypass is blocked due to the risk of condensation.

Optional demand-controlled ventilation

The units deliver a comfortable indoor climate in all conditions at a minimal power consumption by means of automatic demand-controlled ventilation. This is obtained through the application of a humidity sensor, a VOC sensor and/or a CO₂ sensor. The humidity sensor (RH%) continuously monitors extract air humidity and adjusts the fan speed accordingly. The VOC sensor continuously monitors the level of artificial or natural organic chemicals of the extract air and adjusts the air flow level accordingly. Once installed in a room and connected to the HAC accessory control unit, the CO₂ sensor continuously monitors the CO₂ level and adjusts the air change accordingly.

Filters

All Dantherm residential ventilation units are fitted with G4 filters as standard for both supply air and extract air. This filter will meet the majority of air cleaning needs. F7 pollen and dust filters are available as optional accessories. F7 filters will ensure that allergens do not enter the house through the ventilation system.

VOC air quality demand sensor

The units can be fitted with a VOC air quality sensor. This sensor will continuously monitor the level of artificial as well as natural organic fumes in the air.

Examples of included fumes:

- Natural fumes, e.g. formaldehyde from building materials
- Chemical fumes from sprays, e.g. hair spray or perfumes
- Indoor pollution e.g. from smoking and printing with laser printer
- Fumes from fire-retardant substances in carpets, paint and furniture

Using the VOC sensor in demand mode will result in the correct level of ventilation with the lowest possible power consumption. If a wireless remote control or App is connected, the actual VOC level will be shown in the display using a 3 level icon.

RH% demand sensor

The residential ventilation units are fitted with a humidity sensor (RH%). This sensor will continuously monitor the humidity of the extract air and adjust the air flow level accordingly. This operation is named demand mode. If a wireless remote control is connected, the level will be shown in the display using a 3 level icon. Using demand mode will result in the correct level of ventilation at the lowest possible electrical power consumption. If both VOC and RH% sensors are fitted, the ventilation level is determined by the highest demand from just any one of the sensors.

Leakage protection

All the Dantherm units have the best class of protection for external and internal leakages, according to EN 13141-7 <2% (Class A1).

Maintenance

Dantherm residential ventilation units are virtually maintenance-free. We recommend filters to be changed twice a year to maintain optimum performance. An alarm will indicate when the filters need to be replaced with new ones. Apart from changing the filters and cleaning the outside of the unit, any other form of service has to be carried out by qualified personnel.



INTRODUCTION

VENTILATION WITH HEAT RECOVERY

The intelligent control system of the HCV systems ensures that the heat exchanger does not ice up.

Frost protection is activated if the exhaust air temperature falls below 2°C, which will usually occur when the outdoor air temperature falls below approximately -3°C. The system reduces the volume of supply air to maintain the final exhaust temperature to a minimum of 2°C, therefore keeping the heat exchanger frost free. When it is even colder, the supply air volume will be turned off for short intervals of up to 30 minutes (this is for temperatures lower than -20°C for more than 4 minutes). This is essential for the maintenance and functionality of the unit.

In areas where the outdoor temperatures are often lower than -6°C, you can easily mount preheating to continue to ensure a balanced and reliable solution.

DANTHERM USES 3 TYPES OF COUNTER-FLOW HEAT EXCHANGERS

Aluminium exchangers Characterised by low pressure loss, good sound reduction and high air output.

Plastic exchangers Similar to aluminium exchangers, but tend to have better thermal efficiency.

Enthalpy heat exchangers A special polymer membrane capable of transferring up to 65% of the humidity



Aluminium and plastic heat exchanger

Sensible energy (heat) is recovered from the extract air and transferred to the fresh supply air.

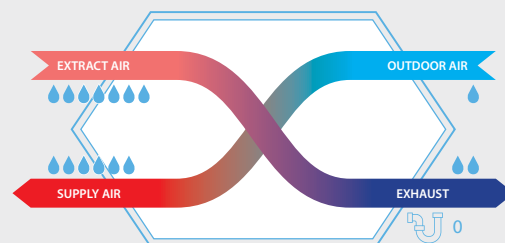

Enthalpy heat exchanger

Sensible energy (heat) and latent energy (humidity) is recovered from the extract air and transferred to the fresh supply air.

INTRODUCTION

ENTHALPY HEAT EXCHANGERS

Enthalpy heat exchangers pass both heat and moisture from one airstream to the other. This keeps humidity within a building at a consistent, comfortable level throughout the year.

Conventional HRV heat exchangers are based on the condensation of water on the walls inside of the exchanger. This is designed to increase the efficiency of the exchanger, but means that condensate is left behind. In contrast, an enthalpy heat exchanger is made from a special polymer membrane. This material allows moisture to penetrate it, unlike the aluminium or plastic used in a traditional heat exchanger. Therefore, an enthalpy heat exchanger allows both heat and moisture to be passed from one airstream to the other. This means that the humidity within a building is kept at a consistent, comfortable level, removing the risk of excessive dryness.

With an enthalpy heat exchanger, because moisture passes through the polymer membrane and across airstreams, very little (if any) condensate will be left behind. This means that the heat exchanger will be at no risk of freezing. This greatly reduced risk of freezing ensures that enthalpy heat exchangers are noticeably more efficient during the colder months of the year. In the winter, the thermal efficiency of an ERV unit greatly outmatches a conventional HRV unit. In addition, the enthalpy heat exchangers in Dantherm units can function down to -5°C , without any preheating. This guarantees balanced ventilation for the main part of the year without preheating, which in turn reduces residents' heating and electricity bills.

The advanced polymer membrane used in these enthalpy heat exchangers blocks the transfer of any odours or contaminants between airstreams, without compromising the transfer of heat and humidity. This removes the risk of bacteria or viruses in the stale air inside the building being recycled back into the supply air. Furthermore, the membrane contains built-in antimicrobial technology, making it resistant to both mould and bacteria. This ensures our enthalpy heat exchangers are extremely hygienic, and no danger to the residents who benefit from the ventilation unit.



The benefits of enthalpy

First and foremost, by allowing for efficient humidity recovery, an enthalpy heat exchanger avoids any of the consequences typically associated with low humidity. These include damage to wooden fixtures and furniture, wall cracks and also health issues like chapped lips, itchy eyes, headache or flaky skin. Instead, relative humidity will be maintained at a comfortable, pleasant level, protecting the health and wellbeing of both residents and buildings.



WALL-MOUNTED



ENERGY-EFFICIENT VENTILATION SOLUTIONS FOR: HOMES, APARTMENTS, NEW-BUILDS AND RENOVATIONS

QUICK GUIDE



HCV 300



HCV 400_{P1}
HCV 400_{P2}
HCV 400_{E1}



HCV 460_{P2}
HCV 460_{E1}



HCV 500



HCV 700

INSTALLATION



WALL-MOUNTED



ATTIC-MOUNTED



CEILING

WALL-MOUNTED UNITS HCV RANGE



For a quick selection of the product range, you can use the selection chart below. The selection chart shows the air volumes at 100Pa pressure loss.

HCV 300	50-180
HCV 400	50-240
HCV 460	50-360
HCV 500	80-300
HCV 700	80-450

Air flow at 100Pa, external pressure (m³/h)

Overview

The HCV 300-400-460-500-700 residential ventilation units are primarily designed for villas and apartments. They meet ventilation requirements of houses up to 450m² or more, depending on national requirements and the actual pressure loss in the installation.

The units are supplied as packaged basic ventilation units complete with built-in control panel, and are delivered with all parts necessary for wall installation. A wide range of additional accessories are available.

The residential ventilation units are fitted with highly efficient counter-flow heat exchangers, which are optimised to a high efficiency level, thus achieving a low power consumption (SPL value) for the entire unit.

Model range

The HCV 300 unit is perfect for concealed installation instead of in a 60 x 60cm cupboard module, e.g. in a modern utility room environment, where everything is hidden behind doors. All ducts are connected to the top of the unit. On the HCV 300 and HCV 400, it is also possible to connect the supply duct to the base if ducts are to run beneath the floor.

HCV 400 and HCV 460 fit into a standard 60 x 60cm cupboard module.

HCV 500 and HCV 700 are ideal for free wall installation with minimum 700mm space. A standard wall rail is supplied with all units.



WALL-MOUNTED UNITS

HCV RANGE

Features

All units are equipped with easy-access filter slots behind the upper front cover. The control panel with LED light indicators is located in an opening in the front cover.

Cabinet

The HCV insulation is made of expanded polystyrene (EPS) components with a minimum wall thickness of 32mm. This allows the units to be placed in rooms with temperatures as low as +12°C.

The outer surface is made of 0.8mm Aluzinc powder-coated sheet metal and painted in RAL 9016. The HCV series complies with European fire safety requirements as specified in EN 13501 class E.

The leakage rate of the unit (internal and external) is <2% as specified in EN13141-7 leakage class A1.

Function

The unit ventilates residential homes by extracting the inside humid air, and replacing it with fresh outside air, which has been heated with the heat energy of the extracted air. This reduces energy consumption.

The air volume can be controlled by:

- Selecting a fixed fan speed from 0-4
- Demand mode, in which a built in RH sensor continuously adjusts the fan speed depending on any immediate demand, determined by the humidity of the extracted air
- Week timer program – the fan speed will increase or decrease according to an hourly time schedule, or specific demand

When very humid inside air is extracted, the humidity will condensate inside the heat exchanger and be collected by the embedded drip tray. This water is drained from the unit through the enclosed hose and then disposed of in the nearest drainage.

Installation

After installation of the unit, ducts and condensate hose, the unit needs to be calibrated to the specific environment. Measurements of air volumes are carried out via built-in air pressure spigots. Appropriate initial adjustments are performed directly on the control panel or with Dantherm PC Tool.

An air flow diagram is present on the front cover, showing the pressure and air volumes the installer must use to calibrate the two air flows (see example opposite).

LEFT SETUP (A)

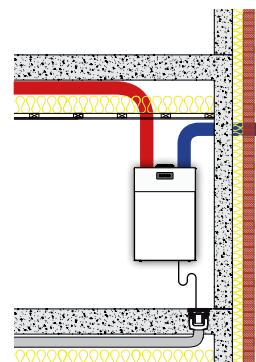

RIGHT SETUP (B)

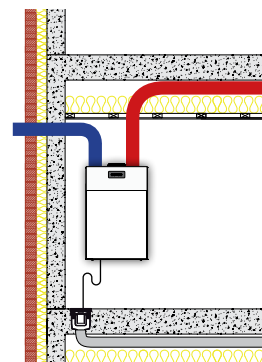

Maintenance

In general, the only regular maintenance required by the HCV residential ventilation units is to check/change the air filters twice a year when the alarm is triggered (flashing LED and acoustic alarm).

The user changes the filter by opening the filter cover, changing the filters and resetting the filter timer on the built-in control panel.

Apart from changing the air filters and cleaning the outside of the unit, any other form of service will have to be carried out by qualified personnel.

Local Dantherm partners are always available with support to solve any problem that might arise with the unit.

Removing the front cover gives access to all types of service and repair.

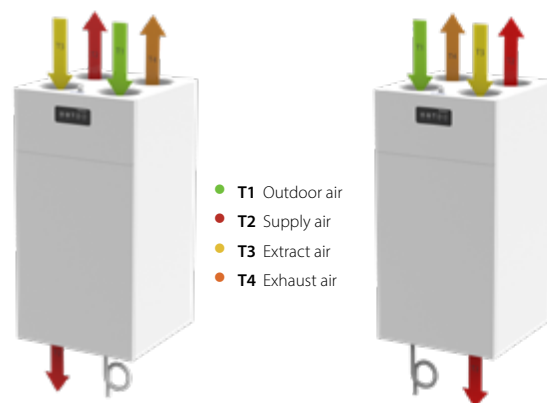

WALL-MOUNTED UNITS

HCV 300



The HCV 300 is a highly efficient residential ventilation unit for houses, villas, and apartments. It comes as a packaged basic ventilation unit complete with built-in control panel, and is delivered with all parts necessary for wall installation. The HCV 300 is also perfect for concealed installation.

The unit is available in a variant without filter lid and with an Aluzinc surface. Delivered four units on a pallet at a time, it minimises the use of packaging in consideration of the environment.



- Demand-controlled ventilation with integrated humidity sensor, reducing power consumption at times with low ventilation demands
- Reduced power consumption at times with low ventilation demands
- Summer mode in which supply fan is stopped and any open window will supply cooler outside air, lowering the room temperature
- Automatic free-cooling features,, via an inbuilt 100% bypass, including the possibility of increasing the air flow automatically, lets in cool night air following hot days to help maintain a comfortable temperature throughout the day
- Fireplace mode, creating a temporary inside overpressure to enhance chimney functionality
- High-efficiency heat recovery
- EC fan motors with extremely low energy consumption (low SPI)
- Highly customisable units with options to add a high variety of internal as well as external accessories
- HCV 300 models take up less space than a 60 x 60cm cupboard and are perfect for concealed installation
- Ducts can be connected to the top of the unit, with the option to connect the supply duct to the base if ducts are to run beneath the floor

Third part tests and certifications

Code	Description
DIBt	Certified by the German Institute of Construction Technology
ErP	Compliant with EU regulations for Eco-design
EPB	Listed in the database for Energy Performance of Buildings in Belgium
Nordic Swan Ecolabel	Listed in the Nordic Swan database for products suitable for Ecolabelled buildings

WALL-MOUNTED UNITS

HCV 300

TECHNICAL DATA

Specifications	Units		HCV 300
Max. flow at 100Pa	V100Pa	m ³ /h	280
Max. rated flow at 100Pa	Vmax.rated	m ³ /h	180
Recommended operating range	V	m ³ /h	50 - 180
EN 13141-7 reference flow	50Pa	m ³ /h	126
Performance			
Thermal efficiency in accordance with EN13141-7	η_{SUP}	%	86
Specific power consumption in accordance with EN13141-7	SFP	W/m ³ /h	0.28
Leakage (external and internal) in accordance with EN13141-7	-	%	<2% (Class A1)
Filters in accordance with ISO16890	-	-	ISO Coarse 75% (optional on supply: ePM1 >50%)
Filters in accordance with EN779	-	-	G4 (optional on supply: F7)
Installation surrounding temperature	t _{SURR}	°C	+12 to +50
Outdoor temperature without preheater installed	t _{ODA}	°C	-12* to +50
Outdoor temperature with preheater installed	t _{ODA}	°C	-20 to +50
Maximum absolute humidity in extract air	x	g/kg	10
Cabinet			
Exterior dimensions without wall brackets	w x d x h	mm	600 x 430 x 1000
Spigots/duct connections	Ø	mm	125 – female
Weight		kg	36
Heat conductivity – polystyrene insulation	λ	W/mK	0.031
Heat transition figures – polystyrene insulation	U	W/m ² K	<1
Fire classification of the polystyrene insulation	class	-	DIN 4102-1 class B2 EN 13501 class E
Drainage hose	Ø/length	"/m	¾ / 1
Cabinet colour	RAL	-	9016
Electrical			
Voltage	U	V	230
Maximum power consumption without/with preheater	P	W	170/870
Frequency	f	Hz	50
Protection class	-	-	IP21

*The use of the preheating coil is recommended at outdoor temperatures below -3°C to ensure balanced ventilation.

WALL-MOUNTED UNITS HCV 300

CAPACITY AND SPI CURVES WITH G4/G4 FILTERS

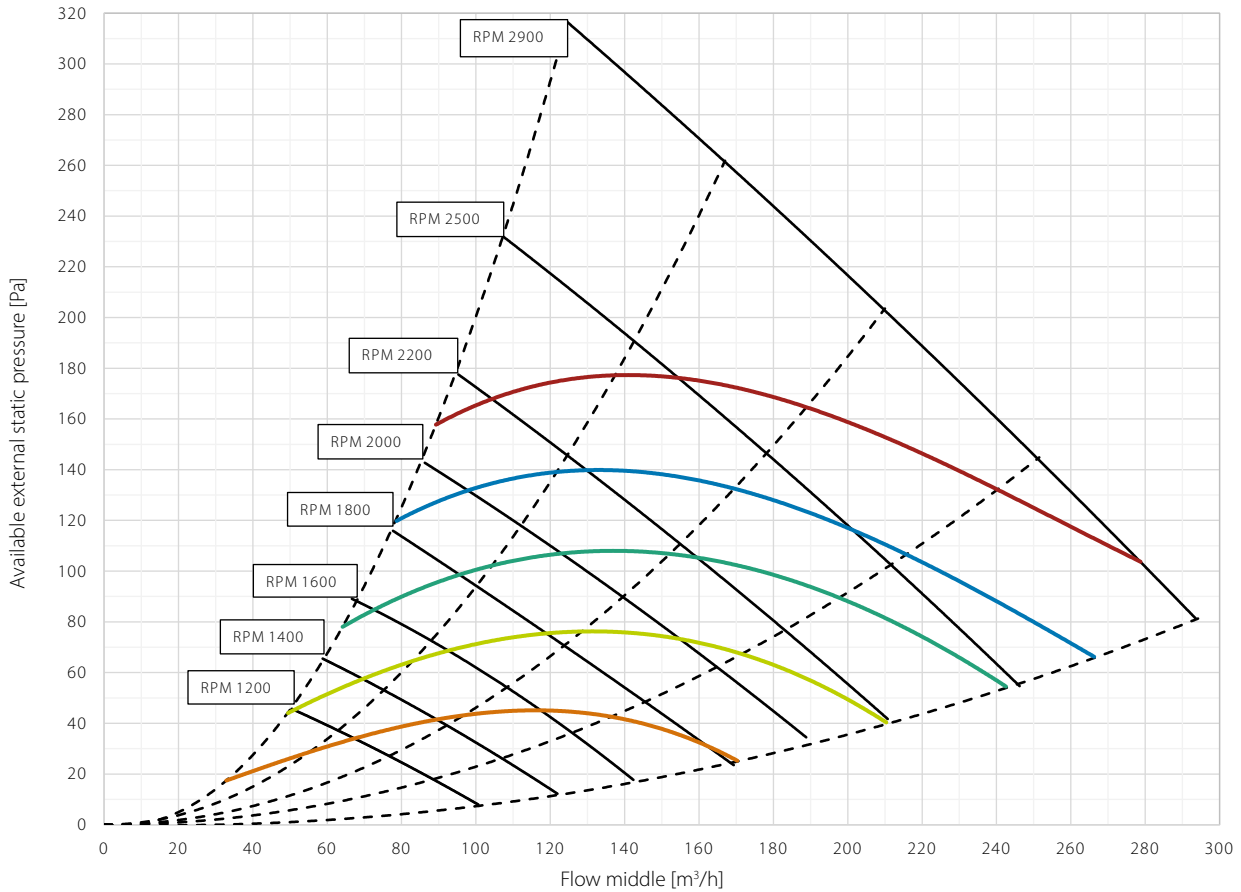

	—	—	—	—	—
SFP/SPI/SEL*	0.45 W/m ³ /h	0.39 W/m ³ /h	0.33 W/m ³ /h	0.28 W/m ³ /h	0.22 W/m ³ /h
	1620 J/m ³	1400 J/m ³	1200 J/m ³	1000 J/m ³	800 J/m ³
	1.62 W/l/s	1.40 W/l/s	1.20 W/l/s	1.0 W/l/s	0.80 W/l/s

* SFP/SPI/SEL includes power consumption of both fans and the control

THERMAL EFFICIENCY CURVES

Legend

- Thermal efficiency according to EN 13141-7 (dry)
Operational conditions: outdoor air: 7°C, 85% RH; extract air: 20°C, 38% RH
- Thermal efficiency according to EN 13141-7 (with condensation)
Operational conditions: outdoor air: 2°C, 80% RH; extract air: 20°C, 60% RH

All values at balanced flow

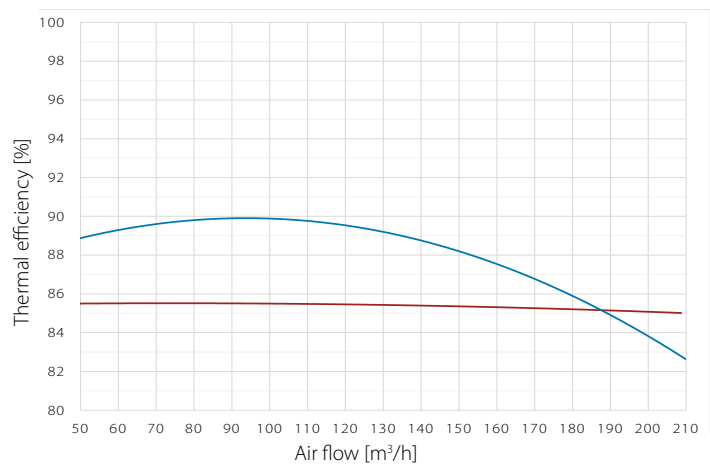

SOUNDS POWER LEVEL (LW) - DUCTS

RPM	Duct	[dB(A)]								
		63Hz	125Hz	250Hz	500Hz	1kHz	2kHz	4kHz	8kHz	Total
1000	supply/exhaust	22.2	23.7	26.3	26.3	23.1	12.7	6.6	18.4	31
	extract/outdoor	23.8	32.1	34.4	38.6	27.9	20.9	9.7	13.0	41
1200	supply/exhaust	24.5	27.3	31.3	30.8	28.5	20.3	20.3	21.9	36
	extract/outdoor	26.4	36.8	38.2	42.3	32.1	27.1	17.7	16.7	45
1400	supply/exhaust	27.3	30.1	35.1	35.6	32.8	26.8	21.4	22.4	40
	extract/outdoor	29.2	38.3	41.5	45.6	35.5	31.6	22.3	21.8	48
1600	supply/exhaust	29.5	31.0	38.9	38.5	35.8	30.1	22.8	22.8	43
	extract/outdoor	32.1	38.5	44.7	49.2	38.6	35.5	26.4	22.0	51
1800	supply/exhaust	31.7	33.0	42.3	41.3	38.7	33.1	23.9	23.2	46
	extract/outdoor	34.1	39.6	48.2	51.4	41.3	38.5	30.0	22.2	54
2000	supply/exhaust	33.8	34.9	47.4	43.6	41.5	35.9	25.3	23.6	50
	extract/outdoor	36.0	41.4	56.1	53.0	43.4	40.8	32.8	22.4	58
2200	supply/exhaust	36.2	36.5	49.3	45.5	44.1	38.6	28.1	24.3	52
	extract/outdoor	38.3	43.4	56.2	54.6	45.7	43.2	35.6	22.7	59
2500	supply/exhaust	39.1	38.9	52.4	48.9	47.2	41.8	31.1	24.7	55
	extract/outdoor	42.2	47.8	57.6	57.4	47.2	44.0	36.4	22.8	61
2900	supply/exhaust	41.6	41.8	55.1	53.4	51.1	45.4	35.7	27.3	59
	extract/outdoor	44.8	50.7	61.0	61.9	51.2	47.8	41.3	25.2	65

SOUND PRESSURE LEVEL (LP) – CABINET

1m distance

RPM	[dB(A)]								
	63Hz	125Hz	250Hz	500Hz	1kHz	2kHz	4kHz	8kHz	Total
1000	5.8	13.6	16.6	22.2	16.6	9.3	7.9	2.9	24
1200	6.4	13.5	20.1	22.4	19.5	11.8	8.3	4.0	26
1400	7.0	17.0	23.8	26.3	24.8	17.9	10.5	4.0	30
1600	8.2	19.4	29.6	28.6	27.0	21.4	20.9	13.7	34
1800	9.2	20.0	34.2	31.5	30.3	25.3	21.1	13.8	38
2000	9.9	21.0	34.6	33.6	32.3	27.5	21.3	6.7	39
2200	10.4	22.1	34.2	35.9	34.4	30.2	21.5	10.2	40
2500	12.6	24.8	36.7	39.1	37.6	33.1	24.2	14.7	43
2900	15.7	27.6	38.3	42.4	40.7	36.8	28.7	20.2	46

2m distance

RPM	[dB(A)]								
	63Hz	125Hz	250Hz	500Hz	1kHz	2kHz	4kHz	8kHz	Total
1000	5.5	10.1	4.2	22.1	16.5	9.0	7.5	1.6	24
1200	4.2	10.3	13.4	23.2	18.7	11.3	7.9	1.6	25
1400	5.1	13.0	16.6	24.8	21.0	14.0	8.3	2.9	27
1600	5.8	13.9	21.4	28.0	24.6	21.4	20.7	13.5	31
1800	6.4	16.3	29.2	31.0	27.6	24.0	20.7	13.7	35
2000	6.5	17.3	29.3	33.3	30.4	25.3	21.2	13.8	37
2200	8.5	19.2	30.3	35.8	32.1	27.7	21.3	14.0	39
2500	12.2	22.7	31.5	38.5	35.5	30.9	22.3	14.2	41
2900	15.1	25.2	35.2	42.1	38.6	34.7	26.4	17.7	45

WALL-MOUNTED UNITS HCV 300

DIMENSIONS

On the HCV 300 it is possible to connect the supply duct to the bottom if the ducts are to run beneath the floor.

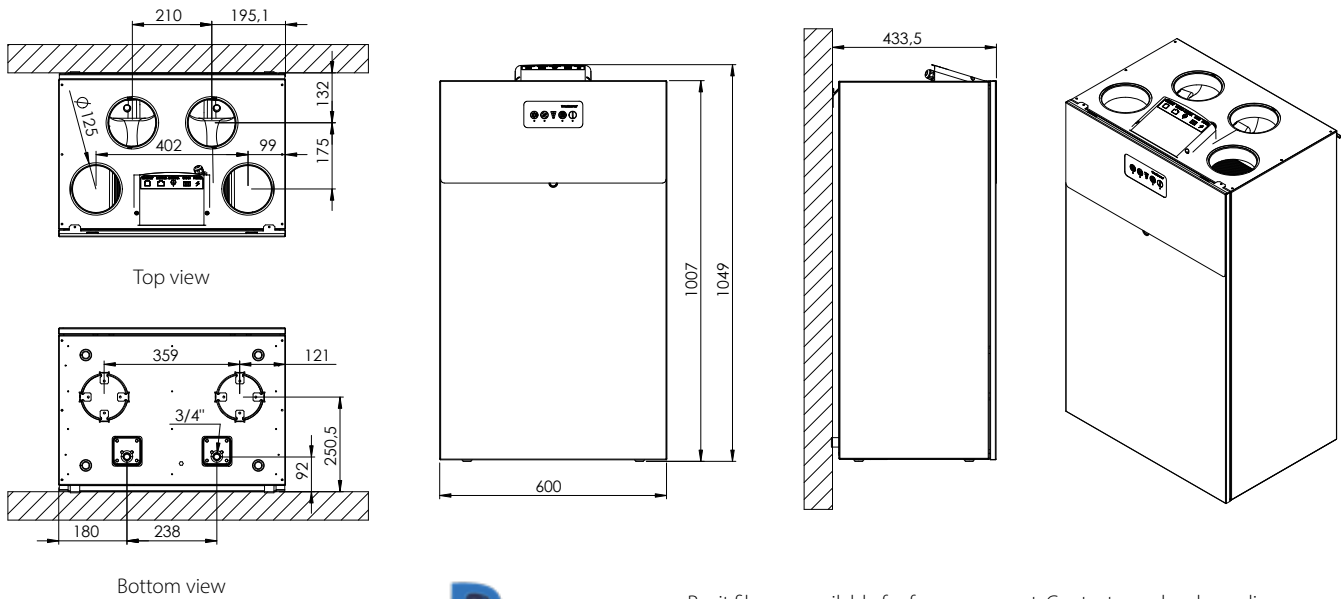

Revit files are available for free on request. Contact your local supplier or Dantherm for access.

DUCT CONNECTIONS

2 set-up in 1 unit, easy change on site

(A) LEFT SET-UP
Factory set-up



- T1 Outdoor air
- T2 Supply air
- T3 Extract air
- T4 Exhaust air

(B) RIGHT SET-UP Optional -
easy change on site



On the HCV 300 it is possible to connect the supply duct to the bottom if the ducts are to run beneath the floor

WALL-MOUNTED UNITS

HCV 400_{P1}



The HCV 400_{P1} is a highly efficient residential ventilation unit for houses, villas, and apartments. It comes supplied as a packaged basic ventilation unit complete with built-in control panel, and is delivered with all parts necessary for wall installation. All HCV 400 units fit perfectly in a 60 x 60cm cupboard.

The unit is available in a variant without filter lid and with an Aluzinc surface. Delivered four units on a pallet at a time, it minimises the use of packaging in consideration of the environment.



- Demand-controlled ventilation with integrated humidity sensor, reducing power consumption at times with low ventilation demands
- Summer mode in which the supply fan is stopped and any open window will supply cooler outside air, lowering the room temperature
- Automatic free-cooling features via inbuilt 100% bypass, including the possibility of increasing the air flow automatically, lets in cool night air following hot days to help maintain a comfortable temperature throughout the day
- Fireplace mode, creating a temporary inside overpressure to enhance chimney functionality
- High-efficiency heat recovery
- EC fan motors with extremely low-energy consumption (low SPI)
- Easy-to-install and commission solution with built-in air pressure spigots for easy calibration
- Highly customisable units with the option to add a high variety of internal as well as external accessories
- Ducts can be connected to the top of the unit, with the option to connect the supply duct to the base if ducts are to run beneath the floor
- The HCV 400 takes up only as little space as a 60 x 60cm cupboard

Third party testing and certification

Code	Description
PHI	Passivhaus certified
PCDB listed SAP App. Q	Listed in the UK database for balanced whole-house mechanical ventilation with heat recovery
ErP	Compliant with EU regulations for Eco-design
EPB	Listed in the database for Energy Performance of Buildings in Belgium
Nordic Swan Ecolabel	Listed in the Nordic Swan database for products suitable for Ecolabelled buildings

WALL-MOUNTED UNITS

HCV 400_{P1}

TECHNICAL DATA

Specifications	Units		HCV 400 _{P1}
Max. flow	V100Pa	m ³ /h	380
Max. rated flow	V _{max.rated}	m ³ /h	250
Recommended operating range	V	m ³ /h	50 - 250
EN 13141-7 reference flow at 50Pa	V _{ref}	m ³ /h	175
Performance			
Thermal efficiency in accordance with EN13141-7	η_{SUP}	%	92
Specific power consumption in accordance with EN13141-7	SEL/SYI	W(m ³ /h)	0.23
Leakage (external and internal) in accordance with EN13141-7	-	%	<2% (Class A1)
Filters in accordance with ISO16890	-	-	ISO Coarse 75% (optional on supply: ePM1>50%)
Filters in accordance with EN779	-	-	G4 (optional on supply: F7)
Installation ambient temperature	t _{SURR}	°C	+12 to +50
Outdoor temperature range without preheater installed	t _{ODA}	°C	-12* to +50
Outdoor temperature range with preheater installed	t _{ODA}	°C	-20 to +50
Maximum absolute humidity in extract air	x	g/kg	10
Cabinet			
Dimensions (without wall bracket)	w x d x h	mm	540 x 549 x 1050
Spigots/duct connections	Ø	mm	160 – female
Weight		kg	39
Thermal conductivity – polystyrene insulation	λ	W/mK	0.031
Heat transition figures – polystyrene insulation	U	W/m ² K	<1
Fire classification of the polystyrene insulation	-	-	DIN 4102-1 class B2 EN 13501 class E
Drainage hose	Ø/length	"/m	¾ / 1
Cabinet colour	RAL	-	9016
Electrical			
Voltage	U	V	230
Maximum power consumption (without/with preheater)	P	W	170/1,570
Frequency	f	Hz	50
Protection class	-	-	IP21

*The use of the preheating coil is recommended at outdoor temperature below -3°C to ensure balanced operation.

CAPACITY AND SPI CURVES WITH G4/G4 FILTERS

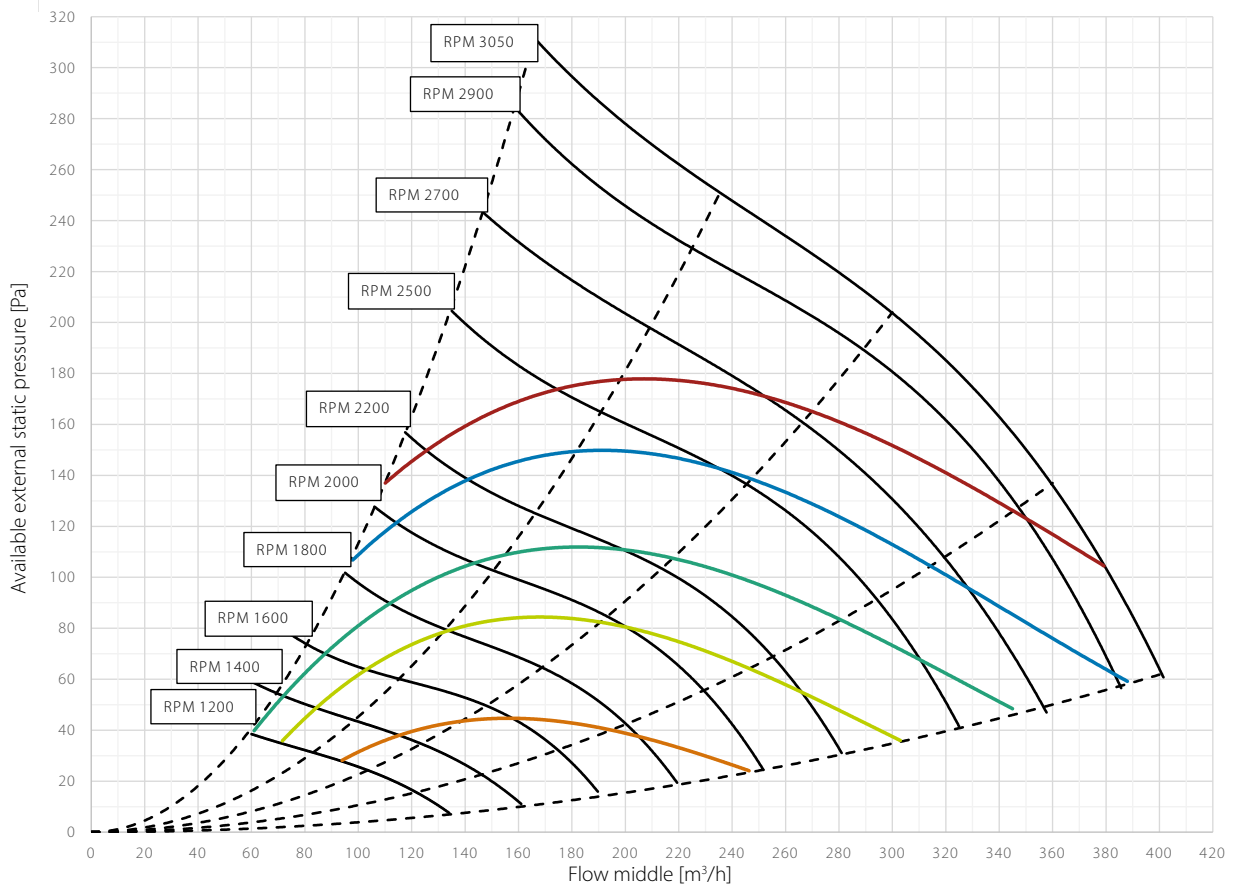

	—	—	—	—	—
SFP/SPI/SEL*	0.45 W/m ³ /h	0.39 W/m ³ /h	0.33 W/m ³ /h	0.28 W/m ³ /h	0.22 W/m ³ /h
	1620 J/m ³	1400 J/m ³	1200 J/m ³	1000 J/m ³	800 J/m ³
	1.62 W/l/s	1.40 W/l/s	1.20 W/l/s	1.0 W/l/s	0.80 W/l/s

* SFP/SPI/SEL includes power consumption of both fans and the control.

THERMAL EFFICIENCY CURVES

Legend

- Thermal efficiency according to EN 13141-7 (dry)
Operational conditions: outdoor air: 7°C, 88% RH; extract air: 20°C, 37% RH
- Thermal efficiency according to EN 13141-7 (with condensation)
Operational conditions: outdoor air: 2°C, 84% RH; extract air: 20°C, 60% RH
- Thermal efficiency acc. PassivHaus Institut
Operational conditions: outdoor air: 4°C, 85% RH; extract air: 21°C, 32% RH

All values at balanced flow

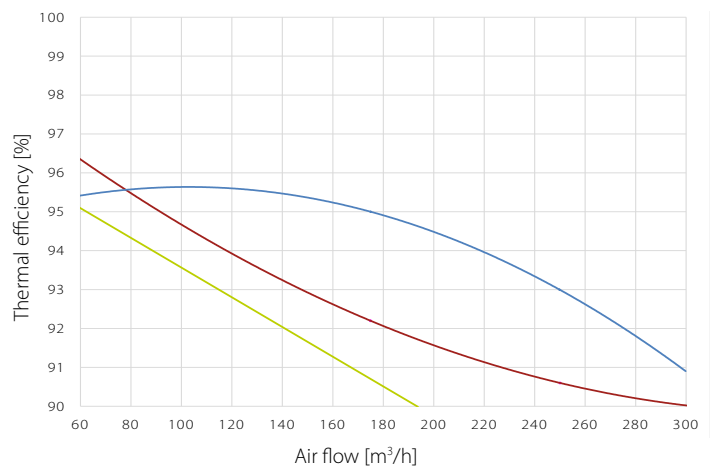

WALL-MOUNTED UNITS

HCV 400_{P1}

SOUND POWER LEVEL (L_w) – DUCTS

RPM	Duct	[dB(A)]								
		63Hz	125Hz	250Hz	500Hz	1kHz	2kHz	4kHz	8kHz	Total
1200	supply/exhaust	27.9	29.4	30.7	29.7	26.3	23.1	17.5	23.3	36
	extract/outdoor	28.0	38.1	38.1	37.5	30.6	29.4	15.5	13.7	43
1400	supply/exhaust	30.6	30.6	34.8	33.7	29.9	26.8	19.1	23.4	39
	extract/outdoor	30.6	39.3	41.2	41.2	33.7	33.5	20.2	16.4	46
1600	supply/exhaust	32.4	31.2	38.4	37.2	32.9	30.5	20.9	23.8	42
	extract/outdoor	33.3	39.4	46.1	44.8	37.0	37.2	25.1	17.7	50
1800	supply/exhaust	34.6	33.3	44.2	40.7	35.8	33.5	22.9	23.8	47
	extract/outdoor	34.7	40.8	49.1	47.3	39.2	39.2	28.6	18.8	52
2000	supply/exhaust	35.8	34.0	48.8	43.6	38.5	36.2	24.9	24.1	51
	extract/outdoor	36.8	41.9	53.7	48.8	42.0	41.9	31.9	19.6	56
2200	supply/exhaust	37.6	35.0	50.6	46.3	41.0	38.7	28.2	24.8	53
	extract/outdoor	38.4	43.0	55.2	50.1	44.0	43.8	34.3	24.3	57
2500	supply/exhaust	40.5	36.8	53.5	48.5	44.4	41.9	31.3	25.4	55
	extract/outdoor	41.3	45.4	58.6	53.9	47.5	47.1	38.2	31.0	60
2700	supply/exhaust	41.9	38.9	54.4	50.2	46.4	43.7	33.7	27.7	57
	extract/outdoor	42.8	47.2	60.7	57.7	49.6	48.9	40.4	33.6	63
2900	supply/exhaust	43.4	40.3	54.4	52.5	48.7	45.5	35.7	29.2	58
	extract/outdoor	44.4	48.8	60.1	61.7	51.7	50.6	42.0	35.5	65

SOUND PRESSURE LEVEL (L_P) – CABINET

1m distance

RPM	[dB(A)]								
	63Hz	125Hz	250Hz	500Hz	1kHz	2kHz	4kHz	8kHz	Total
1200	-	-	12.9	19.5	21.5	21.9	18.0	10.3	27
1400	-	5.7	18.5	23.8	23.5	23.5	18.5	10.6	29
1600	-	6.0	22.1	26.9	26.3	27.6	18.8	11.0	32
1800	-	6.9	25.3	29.4	28.2	28.3	20.6	12.0	34
2000	-	7.6	27.8	31.2	30.7	30.5	22.6	14.3	36
2200	-	8.0	31.3	33.3	32.6	32.8	24.8	17.4	39
2600	-	10.5	31.3	38.2	37.0	36.9	29.7	22.8	43
3000	-	13.1	31.4	43.1	40.2	40.0	33.0	26.1	47
3400	-	16.7	33.8	49.7	44.5	43.3	36.5	29.8	52

2m distance

RPM	[dB(A)]								
	63Hz	125Hz	250Hz	500Hz	1kHz	2kHz	4kHz	8kHz	Total
1200	-	-	8.7	18.6	21.5	21.9	18.0	10.3	27
1400	-	-	12.7	22.1	22.8	22.8	18.5	10.6	28
1600	-	-	16.9	25.3	25.5	24.9	18.8	11.0	31
1800	-	2.1	20.0	28.6	27.2	26.4	20.6	12.0	33
2000	-	3.5	22.9	30.9	29.4	28.5	21.7	13.6	35
2200	-	5.0	26.4	32.6	31.4	30.1	23.2	15.3	37
2600	-	8.1	27.3	37.2	36.3	33.8	27.1	19.9	41
3000	-	11.0	30.0	43.1	39.1	37.2	30.7	23.6	46
3400	-	14.0	30.9	49.7	42.7	41.6	34.1	27.1	51

WALL-MOUNTED UNITS

HCV 400_{P1}

DIMENSIONS

On the HCV 400 it is possible to connect the supply duct to the bottom if the ducts are to run beneath the floor.

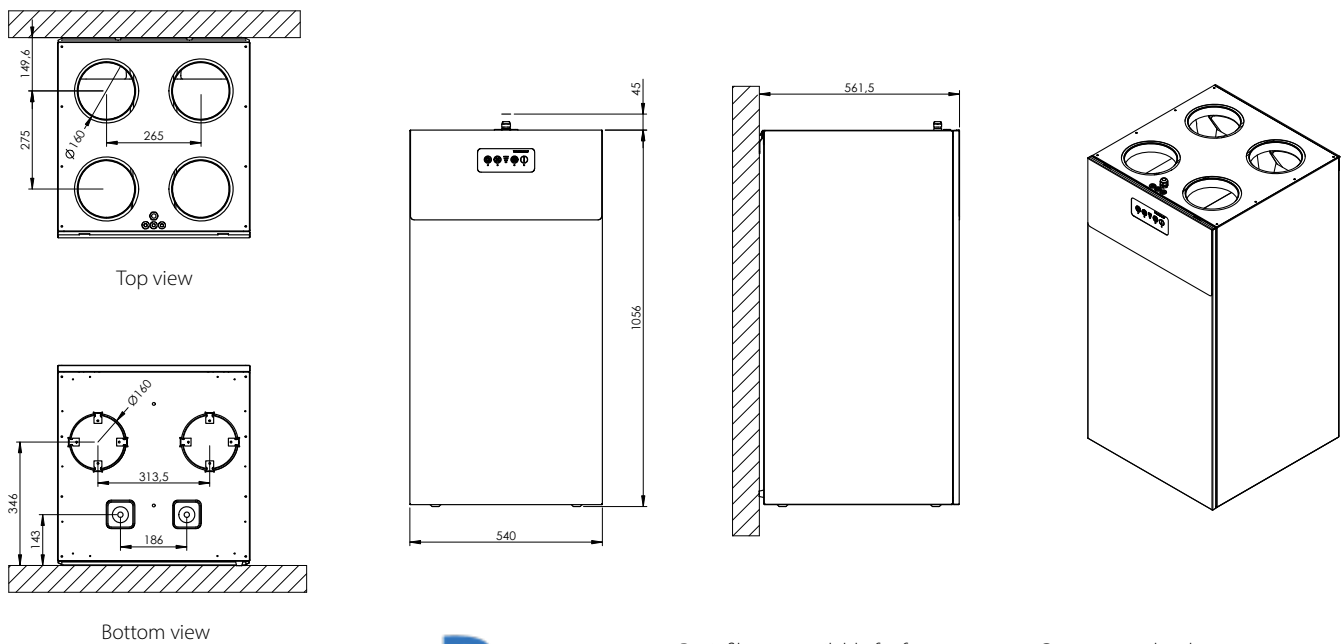

Revit files are available for free on request. Contact your local supplier or Dantherm for access.

DUCT CONNECTIONS

2 set-up in 1 unit, easy change on site

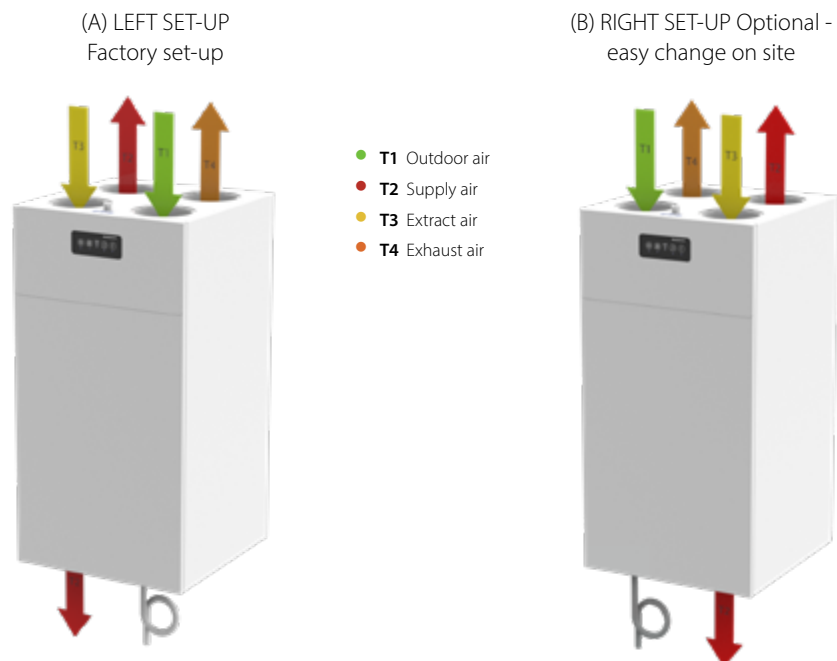

On the HCV 400 it is possible to connect the supply duct to the bottom if the ducts are to run beneath the floor

WALL-MOUNTED UNITS

HCV 400_{P2}



The HCV 400_{P2} is a highly efficient residential ventilation unit for houses, villas, and apartments. It comes supplied as a packaged basic ventilation unit complete with built-in control panel, and is delivered with all parts necessary for wall installation. All HCV 400 units fit perfectly in a 60 x 60cm cupboard.

The unit is available in a variant without filter lid and with an Aluzinc surface. Delivered four units on a pallet at a time, it minimises the use of packaging in consideration of the environment.



- Demand-controlled ventilation with integrated humidity sensor, reducing power consumption at times with low ventilation demands
- Summer mode in which the supply fan is stopped and any open window will supply cooler outside air, lowering the room temperature
- Automatic free-cooling features via inbuilt 100% bypass, including the possibility of increasing the air flow automatically, lets in cool night air following hot days to help maintain a comfortable temperature throughout the day
- Fireplace mode, creating a temporary inside overpressure to enhance chimney functionality
- High-efficiency heat recovery
- EC fan motors with extremely low-energy consumption (low SPI)
- Easy-to-install and commission solution with built-in air pressure spigots for easy calibration
- Highly customisable units with the option to add a high variety of internal as well as external accessories
- Ducts can be connected to the top of the unit, with the option to connect the supply duct to the base if ducts are to run beneath the floor
- The HCV 400 takes up only as little space as a 60 x 60cm cupboard

Third party testing and certifications

Code	Description
ErP	Compliant with EU regulations for Eco-design
Nordic Swan Ecolabel	Listed in the Nordic Swan database for products suitable for Ecolabelled buildings

WALL-MOUNTED UNITS

HCV 400_{P2}

TECHNICAL DATA

Specifications	Units		HCV 400 _{P2}
Max. flow	V100Pa	m ³ /h	330
Max. rated flow	V _{max.rated}	m ³ /h	240
Recommended operating range	V	m ³ /h	50 - 240
EN 13141-7 reference flow at 50Pa	V _{ref}	m ³ /h	168
Performance			
Thermal efficiency in accordance with EN13141-7	η_{SUP}	%	91
Specific power consumption in accordance with EN13141-7	SEL/SYI	W(m ³ /h)	0.20
Leakage (external and internal) in accordance with EN13141-7	-	%	<2% (Class A1)
Filters in accordance with ISO16890	-	-	ISO Coarse 75% (optional on supply: ePM1>50%)
Filters in accordance with EN779	-	-	G4 (optional on supply: F7)
Installation ambient temperature	t _{SURR}	°C	+12 to +50
Outdoor temperature range without preheater installed	t _{ODA}	°C	-12* to +50
Outdoor temperature range with preheater installed	t _{ODA}	°C	-20 to +50
Maximum absolute humidity in extract air	x	g/kg	10
Cabinet			
Dimensions (without wall bracket)	w x d x h	mm	540 x 549 x 1050
Spigots/duct connections	Ø	mm	160 – female
Weight		kg	39
Thermal conductivity – polystyrene insulation	λ	W/mK	0.031
Heat transition figures – polystyrene insulation	U	W/m ² K	<1
Fire classification of the polystyrene insulation	-	-	DIN 4102-1 class B2 EN 13501 class E
Drainage hose	Ø/length	"/m	¾ / 1
Cabinet colour	RAL	-	9016
Electrical			
Voltage	U	V	230
Maximum power consumption (without/with preheater)	P	W	170/1,570
Frequency	f	Hz	50
Protection class	-	-	IP21

*The use of the preheating coil is recommended at outdoor temperature below -3°C to ensure balanced operation.

CAPACITY AND SPI CURVES WITH G4/G4 FILTERS

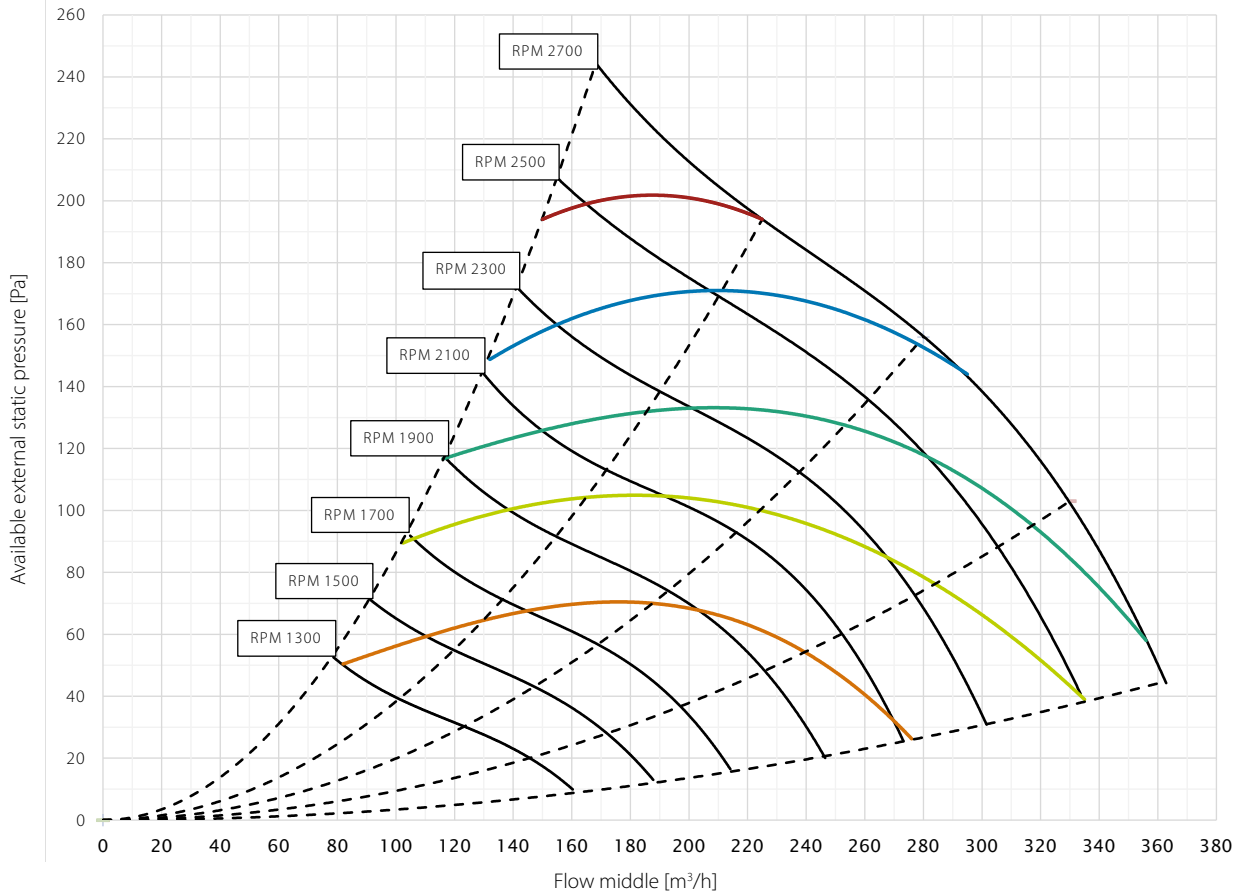

	—	—	—	—	—
SFP/SPI/SEL*	0.45 W/m ³ /h	0.39 W/m ³ /h	0.33 W/m ³ /h	0.28 W/m ³ /h	0.22 W/m ³ /h
	1620 J/m ³	1400 J/m ³	1200 J/m ³	1000 J/m ³	800 J/m ³
	1.62 W/l/s	1.40 W/l/s	1.20 W/l/s	1.0 W/l/s	0.80 W/l/s

* SFP/SPI/SEL includes power consumption of both fans and the control.

THERMAL EFFICIENCY CURVES

Legend

- Thermal efficiency according to EN 13141-7 (dry)
Operational conditions: outdoor air: 7°C, 85% RH; extract air: 20°C, 37% RH
- Thermal efficiency according to EN 13141-7 (with condensation)
Operational conditions: outdoor air: 2°C, 85% RH; extract air: 20°C, 60% RH
- Thermal efficiency acc. PassivHaus Institut
Operational conditions: outdoor air: 4°C, 80% RH; extract air: 21°C, 30% RH

All values at balanced flow

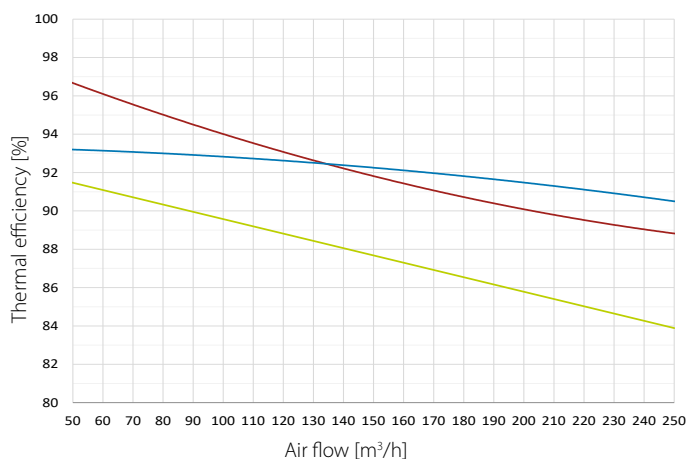

WALL-MOUNTED UNITS

HCV 400_{P2}

SOUND POWER LEVEL (L_w) – DUCTS

RPM	Duct	[dB(A)]								
		63Hz	125Hz	250Hz	500Hz	1kHz	2kHz	4kHz	8kHz	Total
1200	supply/exhaust	26.9	29.6	30.6	30.6	25.8	23.0	11.7	16.4	36
	extract/outdoor	28.0	38.1	38.1	37.5	30.6	29.4	15.5	13.7	43
1300	supply/exhaust	28.8	30.1	32.5	32.4	27.5	24.6	14.5	17.9	37
	extract/outdoor	29.4	39.7	39.8	39.5	32.3	31.7	19.0	16.4	45
1400	supply/exhaust	29.7	30.5	34.4	34.5	29.4	27.1	16.6	19.6	39
	extract/outdoor	30.6	39.3	41.2	41.2	33.7	33.5	20.2	17.7	46
1500	supply/exhaust	31.1	31.3	37.0	36.5	31.3	29.3	18.2	21.0	41
	extract/outdoor	31.8	39.0	43.5	43.1	35.4	35.3	22.3	18.8	48
1600	supply/exhaust	31.9	32.0	38.6	38.0	32.8	31.1	20.3	21.6	43
	extract/outdoor	33.3	38.7	46.1	44.8	37.0	37.2	25.1	19.6	49
1700	supply/exhaust	32.5	32.5	41.6	39.7	34.2	32.6	20.9	22.1	45
	extract/outdoor	34.0	39.2	48.8	46.1	38.3	38.7	26.6	20.4	51
1800	supply/exhaust	32.0	31.1	42.4	41.4	35.9	34.5	22.7	22.6	46
	extract/outdoor	35.2	39.7	52.0	47.2	39.8	40.1	28.7	21.0	54
1900	supply/exhaust	33.1	32.3	43.7	42.8	37.3	36.1	24.6	23.0	47
	extract/outdoor	35.9	40.1	52.4	47.9	40.7	41.2	30.1	21.7	54
2000	supply/exhaust	34.0	33.1	45.3	43.5	38.5	37.2	25.4	23.4	49
	extract/outdoor	37.2	40.8	55.2	48.3	42.1	42.6	31.7	22.6	57
2100	supply/exhaust	34.9	33.6	46.6	44.4	39.8	38.4	26.7	23.8	50
	extract/outdoor	38.1	41.6	56.0	49.2	43.3	43.7	33.2	24.6	57
2200	supply/exhaust	36.7	35.4	48.3	45.4	41.3	39.8	28.6	24.1	51
	extract/outdoor	38.5	42.7	58.5	50.3	44.6	44.9	34.7	27.0	59
2300	supply/exhaust	37.2	36.2	50.9	46.7	42.6	41.0	30.2	24.5	53
	extract/outdoor	39.4	43.3	60.8	51.4	45.4	45.7	35.7	27.8	62
2400	supply/exhaust	38.2	37.0	51.1	47.9	43.6	42.1	31.6	24.7	54
	extract/outdoor	40.4	44.1	60.0	52.7	46.6	46.8	37.0	29.5	61
2500	supply/exhaust	39.3	37.7	51.7	48.9	44.6	43.0	32.7	25.6	55
	extract/outdoor	41.1	45.0	59.3	54.4	47.5	47.7	38.2	30.8	61
2600	supply/exhaust	40.8	38.6	52.3	50.3	45.7	44.0	33.9	27.3	55
	extract/outdoor	42.3	45.5	60.5	56.3	48.6	48.7	39.2	32.2	62
2700	supply/exhaust	40.8	39.3	53.0	51.9	46.6	44.8	34.9	27.6	56
	extract/outdoor	42.4	46.3	62.3	58.3	49.6	49.4	40.1	33.1	64

SOUND PRESSURE LEVEL (L_P) – CABINET

1m distance

RPM	[dB(A)]								
	63Hz	125Hz	250Hz	500Hz	1kHz	2kHz	4kHz	8kHz	Total
1200	-	-	12.9	19.5	21.5	21.9	18.0	10.3	27
1400	-	5.7	18.5	23.8	23.5	23.5	18.5	10.6	29
1600	-	6.0	22.1	26.9	26.3	27.6	18.8	11.0	32
1800	-	6.9	25.3	29.4	28.2	28.3	20.6	12.0	34
2000	-	7.6	27.8	31.2	30.7	30.5	22.6	14.3	36
2200	-	8.0	31.3	33.3	32.6	32.8	24.8	17.4	39
2600	-	10.5	31.3	38.2	37.0	36.9	29.7	22.8	43
3000	-	13.1	31.4	43.1	40.2	40.0	33.0	26.1	47
3400	-	16.7	33.8	49.7	44.5	43.3	36.5	29.8	52

2m distance

RPM	[dB(A)]								
	63Hz	125Hz	250Hz	500Hz	1kHz	2kHz	4kHz	8kHz	Total
1200	-	-	8.7	18.6	21.5	21.9	18.0	10.3	27
1400	-	-	12.7	22.1	22.8	22.8	18.5	10.6	28
1600	-	-	16.9	25.3	25.5	24.9	18.8	11.0	31
1800	-	2.1	20.0	28.6	27.2	26.4	20.6	12.0	33
2000	-	3.5	22.9	30.9	29.4	28.5	21.7	13.6	35
2200	-	5.0	26.4	32.6	31.4	30.1	23.2	15.3	37
2600	-	8.1	27.3	37.2	36.3	33.8	27.1	19.9	41
3000	-	11.0	30.0	43.1	39.1	37.2	30.7	23.6	46
3400	-	14.0	30.9	49.7	42.7	41.6	34.1	27.1	51

WALL-MOUNTED UNITS

HCV 400_{P2}

DIMENSIONS

On the HCV 400 it is possible to connect the supply duct to the bottom if the ducts are to run beneath the floor.

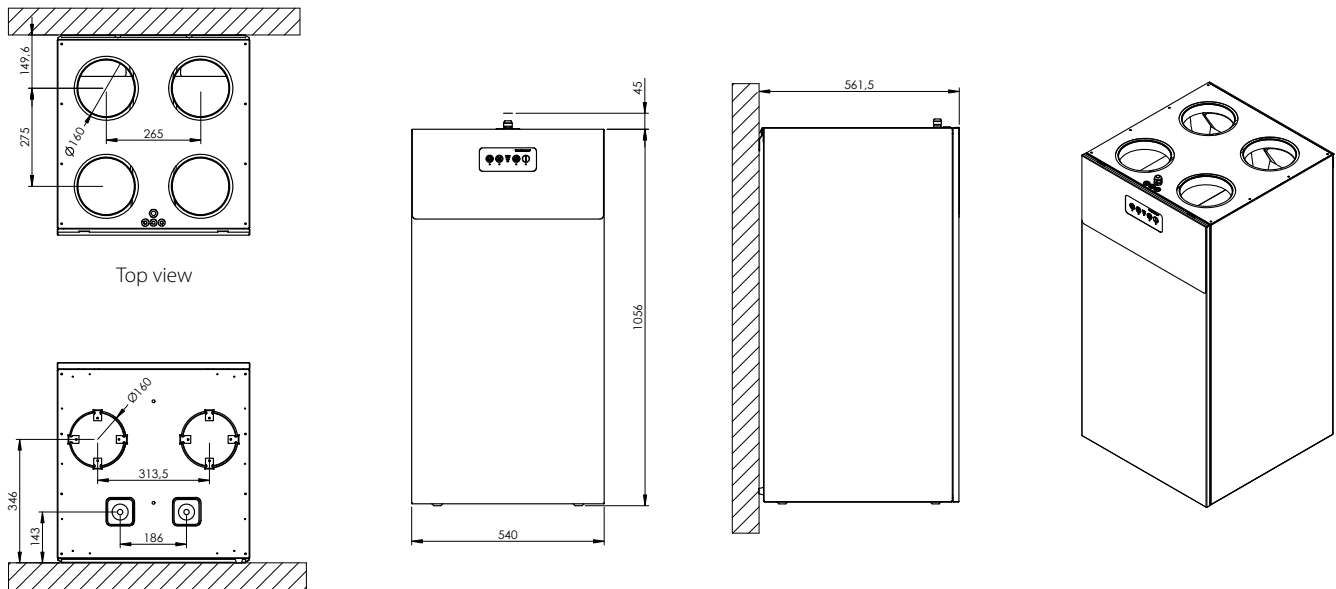

Revit files are available for free on request. Contact your local supplier or Dantherm for access.

DUCT CONNECTIONS

2 set-up in 1 unit, easy change on site

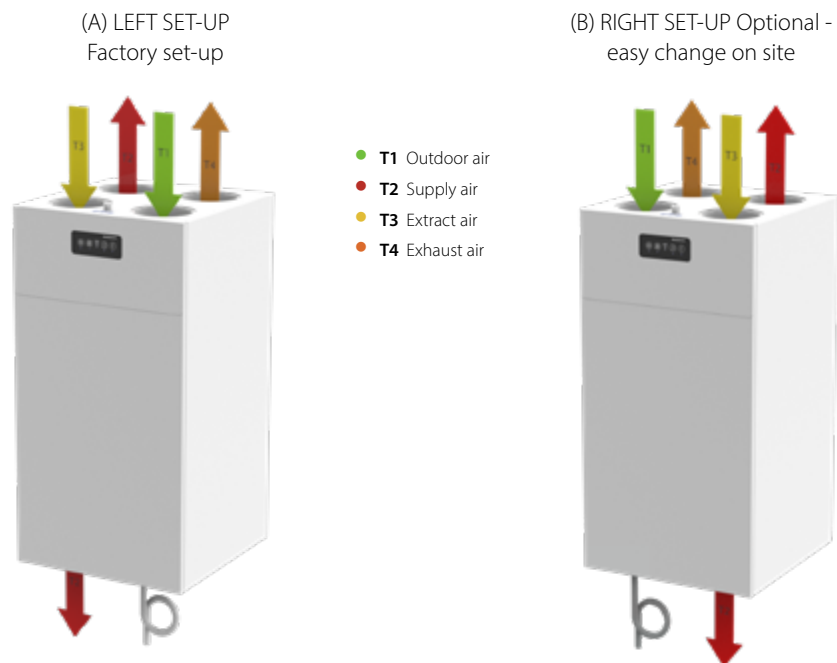

On the HCV 400 it is possible to connect the supply duct to the bottom if the ducts are to run beneath the floor

WALL-MOUNTED UNITS

HCV 400_{E1}



The HCV 400_{E1} is a highly efficient residential ventilation unit for houses, villas, and apartments. It comes supplied as a packaged basic ventilation unit complete with built-in control panel, and is delivered with all parts necessary for wall installation. All HCV 400 units fit perfectly in a 60 x 60cm cupboard.

The unit is available in a variant without filter lid and with an Aluzinc surface. Delivered four units on a pallet at a time, it minimises the use of packaging in consideration of the environment.



- Demand-controlled ventilation with integrated humidity sensor, reducing power consumption at times with low ventilation demands
- Summer mode in which supply fan is stopped and any open window will supply cooler outside air, lowering the room temperature
- Automatic free-cooling features via inbuilt 100% bypass, including the possibility of increasing the air flow automatically, lets in cool night air following hot days to help maintain a comfortable temperature throughout the day
- Fireplace mode, creating a temporary inside overpressure to enhance chimney functionality
- High-efficiency heat recovery
- EC fan motors with extremely low energy consumption (low SPI)
- Easy-to-install and commission solution with built-in air pressure spigots for easy calibration
- Highly customisable units, with the option to add a high variety of internal as well as external accessories
- Ducts can be connected to the top of the unit, with the option to connect the supply duct to the base if ducts are to run beneath the floor
- The HCV 400 takes up only as little space as a 60 x 60cm cupboard

Third party testing and certifications

Code	Description
ErP	Compliant with EU regulations for Eco-design
Nordic Swan Ecolabel	Listed in the Nordic Swan database for products suitable for Ecolabelled buildings

WALL-MOUNTED UNITS

HCV 400_{E1}

TECHNICAL DATA

Specifications	Units		HCV 400 _{E1}
Max. flow	V100Pa	m ³ /h	330
Max. rated flow	V _{max.rated}	m ³ /h	240
Recommended operating range	V	m ³ /h	50 - 240
EN 13141-7 reference flow at 50Pa	V _{ref}	m ³ /h	168
Performance			
Thermal efficiency in accordance with EN13141-7	η_{SUP}	%	84
Specific power consumption in accordance with EN13141-7	SEL/SYI	W(m ³ /h)	0.20
Leakage (external and internal) in accordance with EN13141-7	-	%	<2% (Class A1)
Filters in accordance with ISO16890	-	-	ISO Coarse 75% (optional on supply: ePM1>50%)
Filters in accordance with EN779	-	-	G4 (optional on supply: F7)
Installation ambient temperature	t _{SURR}	°C	+12 to +50
Outdoor temperature range without preheater installed	t _{ODA}	°C	-12* to +50
Outdoor temperature range with preheater installed	t _{ODA}	°C	-20 to +50
Maximum absolute humidity in extract air	x	g/kg	10
Cabinet			
External dimensions (without wall bracket)	w x d x h	mm	540 x 549 x 1050
Spigots/duct connections	Ø	mm	160 – female
Weight		kg	39
Thermal conductivity – polystyrene insulation	λ	W/mK	0.031
Heat transition figures – polystyrene insulation	U	W/m ² K	<1
Fire classification of the polystyrene insulation	-	-	DIN 4102-1 class B2 EN 13501 class E
Drainage hose	Ø/length	"/m	¾ / 1
Cabinet colour	RAL	-	9016
Electrical			
Voltage	U	V	230
Maximum power consumption (without/with preheater)	P	W	170/1,570
Frequency	f	Hz	50
Protection class	-	-	IP21

*The use of the preheating coil is recommended at outdoor temperature below -5°C to ensure balanced operation.

CAPACITY AND SPI CURVES WITH G4/G4 FILTERS

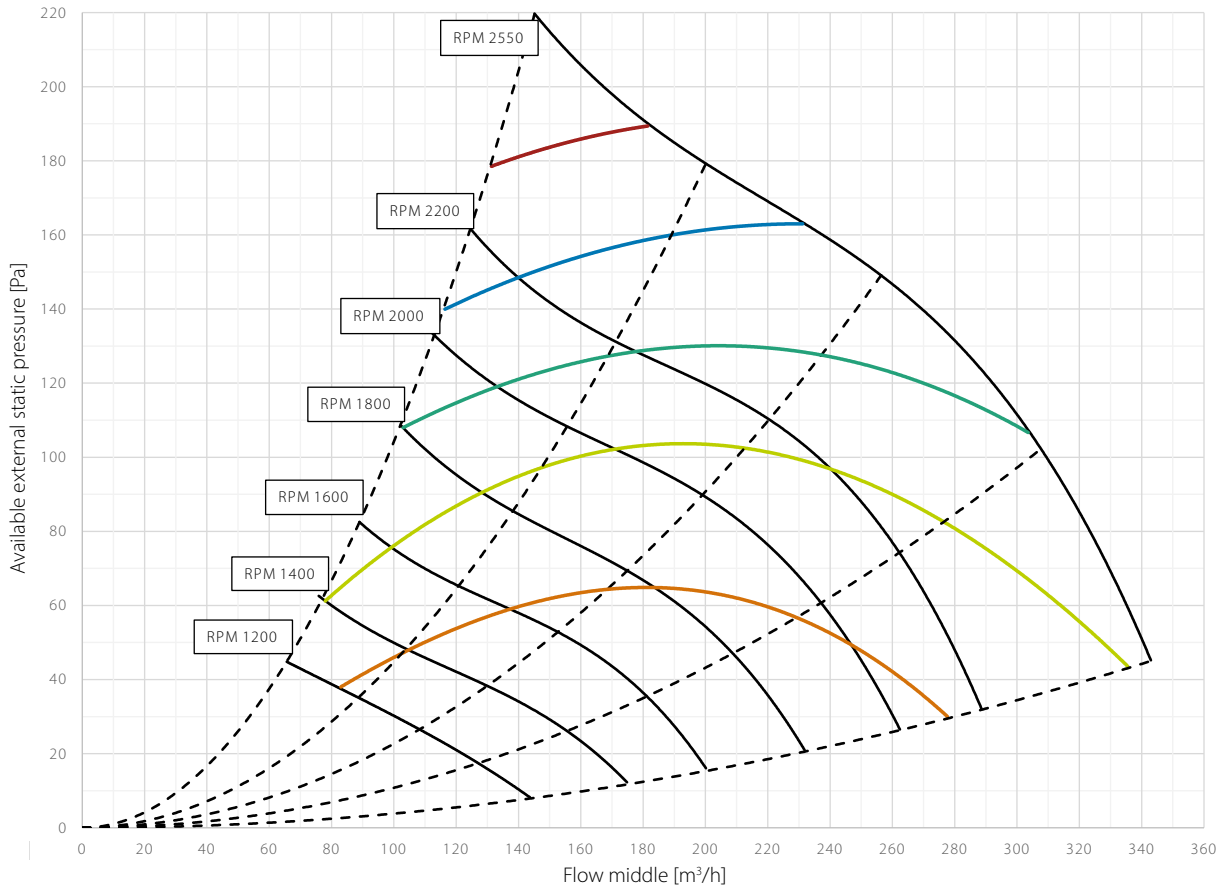

	—	—	—	—	—
SFP/SPI/SEL*	0.45 W/m ³ /h	0.39 W/m ³ /h	0.33 W/m ³ /h	0.28 W/m ³ /h	0.22 W/m ³ /h
	1620 J/m ³	1400 J/m ³	1200 J/m ³	1000 J/m ³	800 J/m ³
	1.62 W/l/s	1.40 W/l/s	1.20 W/l/s	1.0 W/l/s	0.80 W/l/s

* SFP/SPI/SEL includes power consumption of both fans and the control.

THERMAL EFFICIENCY CURVES

Legend

- Thermal efficiency according to EN 13141-7 (dry)
Operational conditions: outdoor air: 7°C, 70% RH; extract air: 20°C, 38% RH
- Humidity efficiency acc. to EN 13141-7 (with condensation)
Operational conditions: outdoor air: 2°C, 88% RH; extract air: 20°C, 60% RH

All values at balanced flow

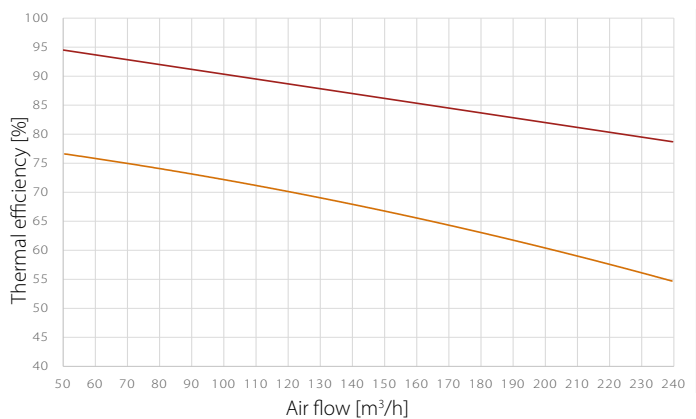

WALL-MOUNTED UNITS

HCV 400 E1

SOUND POWER LEVEL (Lw) – DUCTS

RPM	Duct	[dB(A)]								
		63Hz	125Hz	250Hz	500Hz	1kHz	2kHz	4kHz	8kHz	Total
1200	supply/exhaust	28.6	31.3	32.3	32.3	26.8	23.0	11.7	14.5	37
	extract/outdoor	28.0	38.1	38.1	37.5	30.6	29.4	15.5	16.4	43
1300	supply/exhaust	30.5	31.8	34.2	34.1	28.5	24.6	14.5	17.9	39
	extract/outdoor	29.4	39.7	39.8	39.5	32.3	31.7	19.0	19.0	45
1400	supply/exhaust	31.4	32.2	36.1	36.2	30.4	27.1	16.6	18.3	41
	extract/outdoor	30.6	39.3	41.2	41.2	33.7	33.5	20.2	20.4	46
1500	supply/exhaust	32.8	33.0	38.7	38.2	32.3	29.3	18.2	19.6	43
	extract/outdoor	31.8	39.0	43.5	43.1	35.4	35.3	22.3	21.6	48
1600	supply/exhaust	33.6	33.7	40.3	39.7	33.8	31.1	20.3	20.4	44
	extract/outdoor	33.3	38.7	46.1	44.8	37.0	37.2	25.1	22.1	49
1700	supply/exhaust	34.2	34.2	43.3	41.4	35.2	32.6	20.9	21.0	46
	extract/outdoor	34.0	39.2	48.8	46.1	38.3	38.7	26.6	22.6	51
1800	supply/exhaust	33.7	32.8	44.1	43.1	36.9	34.5	22.7	21.6	47
	extract/outdoor	35.2	39.7	52.0	47.2	39.8	40.1	28.7	23.0	54
1900	supply/exhaust	34.8	34.0	45.4	44.5	38.3	36.1	24.6	22.1	49
	extract/outdoor	35.9	40.1	52.4	47.9	40.7	41.2	30.1	23.4	54
2000	supply/exhaust	35.7	34.8	47.0	45.2	39.5	37.2	25.4	23.0	50
	extract/outdoor	37.2	40.8	55.2	48.3	42.1	42.6	31.7	23.8	57
2100	supply/exhaust	36.6	35.3	48.3	46.1	40.8	38.4	26.7	23.8	51
	extract/outdoor	38.1	41.6	56.0	49.2	43.3	43.7	33.2	24.6	57
2200	supply/exhaust	38.4	37.1	50.0	47.1	42.3	39.8	28.6	24.1	53
	extract/outdoor	38.5	42.7	58.5	50.3	44.6	44.9	34.7	27.0	59
2300	supply/exhaust	38.9	37.9	52.6	48.4	43.6	41.0	30.2	24.5	55
	extract/outdoor	39.4	43.3	60.8	51.4	45.4	45.7	35.7	27.8	62
2400	supply/exhaust	39.9	38.7	52.8	49.6	44.6	42.1	31.6	24.7	55
	extract/outdoor	40.4	44.1	60.0	52.7	46.6	46.8	37.0	29.5	61
2500	supply/exhaust	41.0	39.4	53.4	50.6	45.6	43.0	32.7	25.6	56
	extract/outdoor	41.1	45.0	59.3	54.4	47.5	47.7	38.2	30.8	61
2600	supply/exhaust	42.5	40.3	54.0	52.0	46.7	44.0	33.9	27.3	57
	extract/outdoor	42.3	45.5	60.5	56.3	48.6	48.7	39.2	32.2	62
2700	supply/exhaust	42.5	41.0	54.7	53.6	47.6	44.8	34.9	27.6	58
	extract/outdoor	42.4	46.3	62.3	58.3	49.6	49.4	40.1	33.1	64

SOUND PRESSURE LEVEL (L_P) – CABINET

1m distance

RPM	[dB(A)]								Total
	63Hz	125Hz	250Hz	500Hz	1kHz	2kHz	4kHz	8kHz	
1200	-	-	12.9	19.5	21.5	21.9	18.0	10.3	27
1400	-	5.7	18.5	23.8	23.5	23.5	18.5	10.6	29
1600	-	6.0	22.1	26.9	26.3	27.6	18.8	11.0	32
1800	-	6.9	25.3	29.4	28.2	28.3	20.6	12.0	34
2000	-	7.6	27.8	31.2	30.7	30.5	22.6	14.3	36
2200	-	8.0	31.3	33.3	32.6	32.8	24.8	17.4	39
2600	-	10.5	31.3	38.2	37.0	36.9	29.7	22.8	43
3000	-	13.1	31.4	43.1	40.2	40.0	33.0	26.1	47
3400	-	16.7	33.8	49.7	44.5	43.3	36.5	29.8	52

2m distance

RPM	[dB(A)]								Total
	63Hz	125Hz	250Hz	500Hz	1kHz	2kHz	4kHz	8kHz	
1200	-	-	8.7	18.6	21.5	21.9	18.0	10.3	27
1400	-	-	12.7	22.1	22.8	22.8	18.5	10.6	28
1600	-	-	16.9	25.3	25.5	24.9	18.8	11.0	31
1800	-	2.1	20.0	28.6	27.2	26.4	20.6	12.0	33
2000	-	3.5	22.9	30.9	29.4	28.5	21.7	13.6	35
2200	-	5.0	26.4	32.6	31.4	30.1	23.2	15.3	37
2600	-	8.1	27.3	37.2	36.3	33.8	27.1	19.9	41
3000	-	11.0	30.0	43.1	39.1	37.2	30.7	23.6	46
3400	-	14.0	30.9	49.7	42.7	41.6	34.1	27.1	51

WALL-MOUNTED UNITS

HCV 400 E1

DIMENSIONS

On the HCV 400 it is possible to connect the supply duct to the bottom if the ducts are to run beneath the floor.

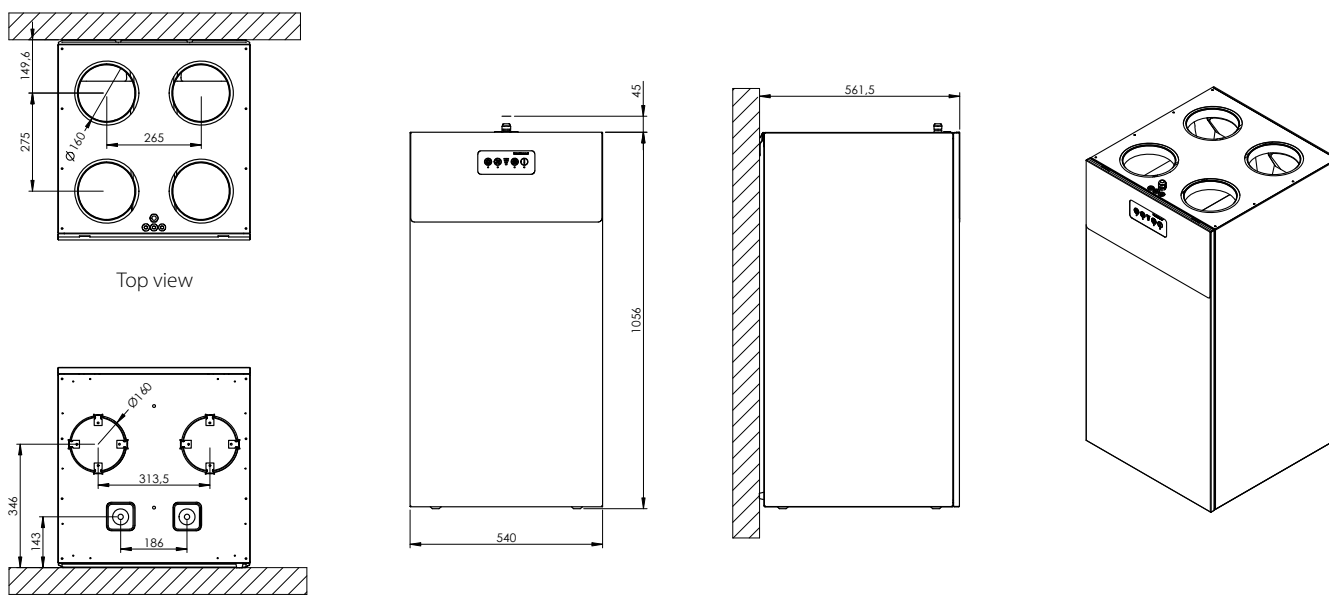

Bottom view



Revit files are available for free on request. Contact your local supplier or Dantherm for access.

DUCT CONNECTIONS

2 set-up in 1 unit, easy change on site

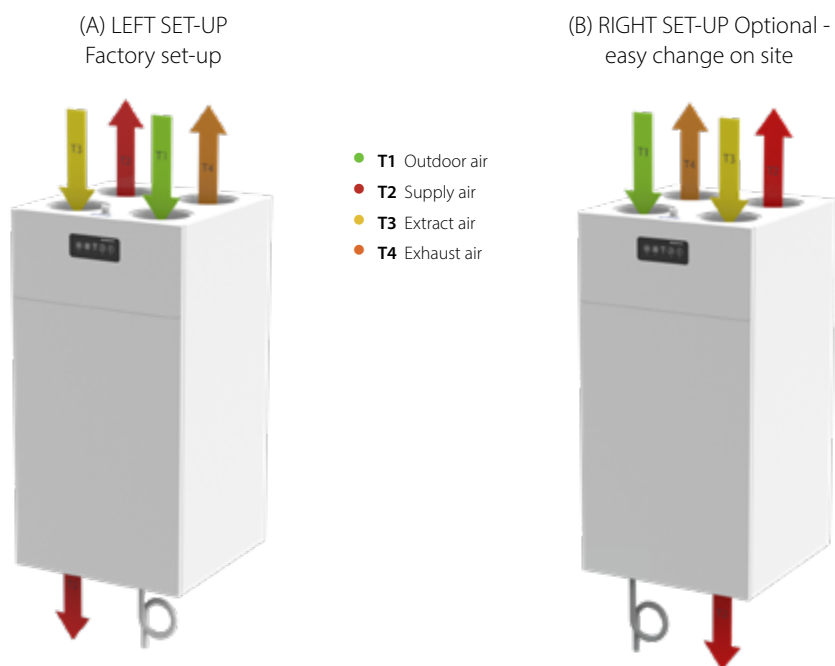

On the HCV 400 it is possible to connect the supply duct to the bottom if the ducts are to run beneath the floor

WALL-MOUNTED UNITS

HCV 460_{P2}



The HCV 460_{P2} is a highly efficient residential ventilation unit for houses, villas, and apartments of up to 450m² or more. It comes supplied as a packaged basic ventilation unit complete with built-in control panel, and is delivered with all parts necessary for wall installation. All HCV 460 units also fit perfectly in a 60 x 60cm cupboard.

The HCV 460 can come in Aluzinc or painted in RAL 9016. The units will be delivered on pallets of four to reduce packaging and shipping costs. This makes it ideal for large-scale projects.



- Demand-controlled ventilation with integrated humidity sensor, reducing power consumption at times with low ventilation demands
- Summer mode in which supply fan is stopped and any open window will supply cooler outside air, lowering the room temperature
- Automatic free-cooling features via inbuilt 100% bypass, including the possibility of increasing the air flow automatically, lets in cool night air following hot days to help maintain a comfortable temperature throughout the day
- Fireplace mode, creating a temporary inside overpressure to enhance chimney functionality
- High-efficiency heat recovery
- EC fan motors with extremely low energy consumption (low SPI)
- Easy-to-install and commission solution with built-in air pressure spigots for easy calibration
- Highly customisable units with the option to add a high variety of internal as well as external accessories
- The HCV 460 takes up only as little space as a 60 x 60cm cupboard

Third party testing and certifications

Code	Description
PHI	Passivhaus certified
PCDB listed SAP App. Q	Listed in the UK database for balanced whole-house mechanical ventilation with heat recovery
ErP	Compliant with EU regulations for Eco-design
Nordic Swan Ecolabel	Listed in the Nordic Swan database for products suitable for Ecolabelled buildings

WALL-MOUNTED UNITS

HCV 460 P2

TECHNICAL DATA

Specifications	Units		HCV 460 _{P2}
Max. flow	V _{100Pa}	m ³ /h	460
Max. rated flow	V _{maxrated}	m ³ /h	360
Operating range DIBt	V _{DIBt}	m ³ /h	70 - 360
Operating range Passivhaus at 100Pa	V _{phi}	m ³ /h	106 - 270
EN 13141-7 reference flow at 50Pa	V _{ref}	m ³ /h	252
Performance			
Thermal efficiency in accordance with EN13141-7	η _{SUP}	%	86
Leakage (external and internal) in accordance with EN 13141-7	-	-	<2% (Class A1)
Filters in accordance with ISO16890	-	-	ISO Coarse 75% (optional on supply: ePM1>50%)
Filters in accordance with EN779	-	-	G4 (optional on supply: F7)
Installation surrounding temperature	t _{SURR}	°C	+12 to +50
Outdoor temperature without preheater installed	t _{ODA}	°C	-12* to +50
Outdoor temperature with preheater installed	t _{ODA}	°C	-20 to +50
Maximum absolute humidity of extract air	x	g/kg	10
Cabinet			
Dimensions (without bracket)	w x h x d	mm	540 x 549 x 1050**
Spigots/ducts connections	∅	mm	160 – female
Weight	-	kg	40
Thermal conductivity – polystyrene insulation	λ	W/mK	0.031
Heat transition figures – polystyrene insulation	U	W/m ² K	U<1
Fire classification of the polystyrene insulation	-	-	DIN 4102-1 class B2 EN 13501 class E
Drainage hose included	∅/length	"/m	¾ / 1
Cabinet colour	RAL	-	9016
Electrical			
Voltage	U	V	230
Maximum power consumption (without/with preheater)	P	W	230/2,080
Frequency	f	Hz	50
Protection class	-	-	IP21

* The use of preheating coil is recommended at outdoor temperature -3°C to ensure balanced operation.

** +20mm fitting.

CAPACITY AND SPI CURVES WITH G4/G4 FILTERS

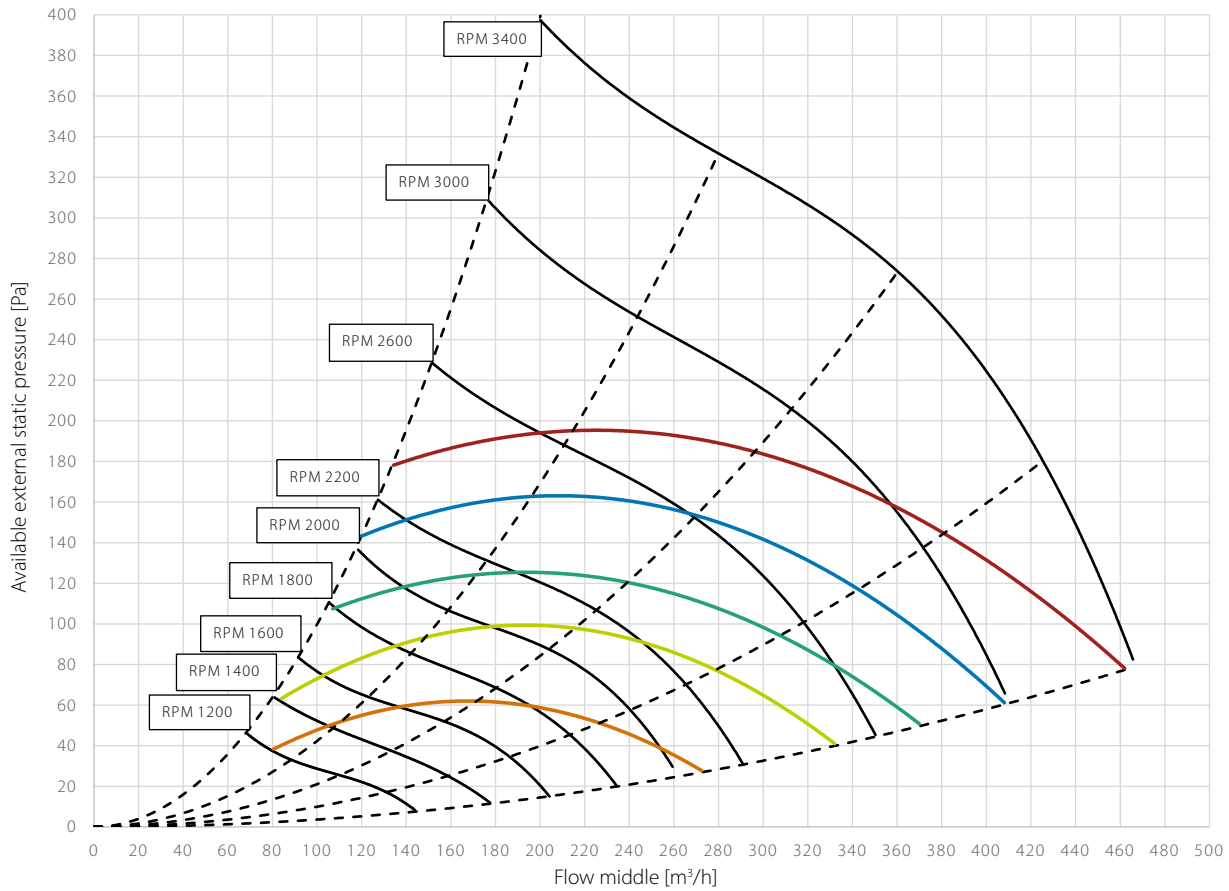

	—	—	—	—	—
SFP/SPI/SEL*	0,5 W/m³/h	0,39 W/m³/h	0,33 W/m³/h	0,28 W/m³/h	0,22 W/m³/h
	1620 J/m³	1400 J/m³	1200 J/m³	1000 J/m³	800 J/m³
	1.62 W/l/s	1.40 W/l/s	1.20 W/l/s	1.0 W/l/s	0.80 W/l/s

* SFP/SPI/SEL includes power consumption of both fans and the control.

THERMAL EFFICIENCY CURVES

Legend

- Thermal efficiency according to EN 13141-7 (dry)
Operational conditions: outdoor air: 7°C, 85% RH; extract air: 20°C, 37% RH
- Thermal efficiency according to EN 13141-7 (with condensation)
Operational conditions: outdoor air: 2°C, 85% RH; extract air: 20°C, 60% RH
- Thermal efficiency acc. PassivHaus Institut
Operational conditions: outdoor air: 4°C, 94% RH; extract air: 21°C, 30% RH

All values at balanced flow

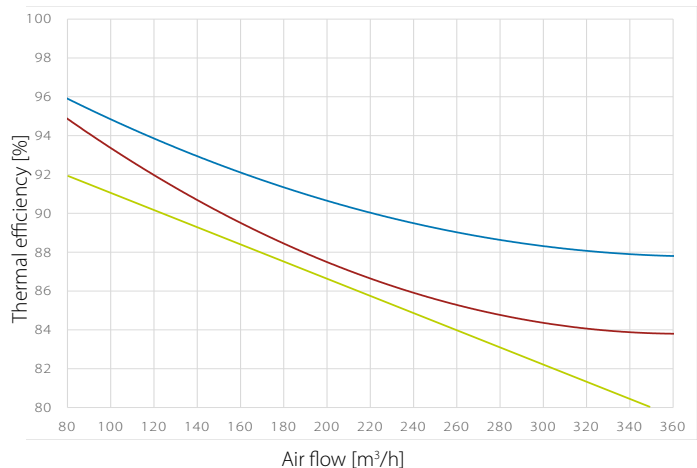

WALL-MOUNTED UNITS

HCV 460_{P2}

SOUND POWER LEVEL (L_w) – DUCTS

RPM	Duct	[dB(A)]								
		63Hz	125Hz	250Hz	500Hz	1kHz	2kHz	4kHz	8kHz	Total
1200	supply/exhaust	26.9	29.6	30.6	30.6	25.8	23.0	11.7	16.4	36
	extract/outdoor	28.0	38.1	38.1	37.5	30.6	29.4	15.5	13.7	43
1300	supply/exhaust	28.8	30.1	32.5	32.4	27.5	24.6	14.5	17.9	37
	extract/outdoor	29.4	39.7	39.8	39.5	32.3	31.7	19.0	16.4	45
1400	supply/exhaust	29.7	30.5	34.4	34.5	29.4	27.1	16.6	19.6	39
	extract/outdoor	30.6	39.3	41.2	41.2	33.7	33.5	20.2	17.7	46
1500	supply/exhaust	31.1	31.3	37.0	36.5	31.3	29.3	18.2	21.0	41
	extract/outdoor	31.8	39.0	43.5	43.1	35.4	35.3	22.3	18.8	48
1600	supply/exhaust	31.9	32.0	38.6	38.0	32.8	31.1	20.3	21.6	43
	extract/outdoor	33.3	38.7	46.1	44.8	37.0	37.2	25.1	19.6	49
1700	supply/exhaust	32.5	32.5	41.6	39.7	34.2	32.6	20.9	22.1	45
	extract/outdoor	34.0	39.2	48.8	46.1	38.3	38.7	26.6	20.4	51
1800	supply/exhaust	32.0	31.1	42.4	41.4	35.9	34.5	22.7	22.6	46
	extract/outdoor	35.2	39.7	52.0	47.2	39.8	40.1	28.7	21.0	54
1900	supply/exhaust	33.1	32.3	43.7	42.8	37.3	36.1	24.6	23.0	47
	extract/outdoor	35.9	40.1	52.4	47.9	40.7	41.2	30.1	21.7	54
2000	supply/exhaust	34.0	33.1	45.3	43.5	38.5	37.2	25.4	23.4	49
	extract/outdoor	37.2	40.8	55.2	48.3	42.1	42.6	31.7	22.6	57
2100	supply/exhaust	34.9	33.6	46.6	44.4	39.8	38.4	26.7	23.8	50
	extract/outdoor	38.1	41.6	56.0	49.2	43.3	43.7	33.2	24.6	57
2200	supply/exhaust	36.7	35.4	48.3	45.4	41.3	39.8	28.6	24.1	51
	extract/outdoor	38.5	42.7	58.5	50.3	44.6	44.9	34.7	27.0	59
2300	supply/exhaust	37.2	36.2	50.9	46.7	42.6	41.0	30.2	24.5	53
	extract/outdoor	39.4	43.3	60.8	51.4	45.4	45.7	35.7	27.8	62
2400	supply/exhaust	38.2	37.0	51.1	47.9	43.6	42.1	31.6	24.7	54
	extract/outdoor	40.4	44.1	60.0	52.7	46.6	46.8	37.0	29.5	61
2500	supply/exhaust	39.3	37.7	51.7	48.9	44.6	43.0	32.7	25.6	55
	extract/outdoor	41.1	45.0	59.3	54.4	47.5	47.7	38.2	30.8	61
2600	supply/exhaust	40.8	38.6	52.3	50.3	45.7	44.0	33.9	27.3	55
	extract/outdoor	42.3	45.5	60.5	56.3	48.6	48.7	39.2	32.2	62
2700	supply/exhaust	40.8	39.3	53.0	51.9	46.6	44.8	34.9	27.6	56
	extract/outdoor	42.4	46.3	62.3	58.3	49.6	49.4	40.1	33.1	64
3000	supply/exhaust	44.3	41.5	52.0	57.2	49.6	47.5	37.9	30.8	59
	extract/outdoor	45.6	48.4	60.7	64.8	52.9	52.2	43.0	36.4	67
3400	supply/exhaust	48.6	44.0	51.2	62.2	52.4	50.3	41.0	33.9	63
	extract/outdoor	47.4	50.8	58.5	71.7	55.6	55.1	46.1	39.5	72

SOUND PRESSURE LEVEL (L_p) – CABINET

1m distance

RPM	[dB(A)]								Total
	63Hz	125Hz	250Hz	500Hz	1kHz	2kHz	4kHz	8kHz	
1200	-	-	12.9	19.5	21.5	21.9	18.0	10.3	27
1400	-	5.7	18.5	23.8	23.5	23.5	18.5	10.6	29
1600	-	6.0	22.1	26.9	26.3	27.6	18.8	11.0	32
1800	-	6.9	25.3	29.4	28.2	28.3	20.6	12.0	34
2000	-	7.6	27.8	31.2	30.7	30.5	22.6	14.3	36
2200	-	8.0	31.3	33.3	32.6	32.8	24.8	17.4	39
2600	-	10.5	31.3	38.2	37.0	36.9	29.7	22.8	43
3000	-	13.1	31.4	43.1	40.2	40.0	33.0	26.1	47
3400	-	16.7	33.8	49.7	44.5	43.3	36.5	29.8	52

2m distance

RPM	[dB(A)]								Total
	63Hz	125Hz	250Hz	500Hz	1kHz	2kHz	4kHz	8kHz	
1200	-	-	8.7	18.6	21.5	21.9	18.0	10.3	27
1400	-	-	12.7	22.1	22.8	22.8	18.5	10.6	28
1600	-	-	16.9	25.3	25.5	24.9	18.8	11.0	31
1800	-	2.1	20.0	28.6	27.2	26.4	20.6	12.0	33
2000	-	3.5	22.9	30.9	29.4	28.5	21.7	13.6	35
2200	-	5.0	26.4	32.6	31.4	30.1	23.2	15.3	37
2600	-	8.1	27.3	37.2	36.3	33.8	27.1	19.9	41
3000	-	11.0	30.0	43.1	39.1	37.2	30.7	23.6	46
3400	-	14.0	30.9	49.7	42.7	41.6	34.1	27.1	51

WALL-MOUNTED UNITS

HCV 460_{P2}

DIMENSIONS

On the HCV 460 it is possible to connect the supply duct to the bottom if the ducts are to run beneath the floor.

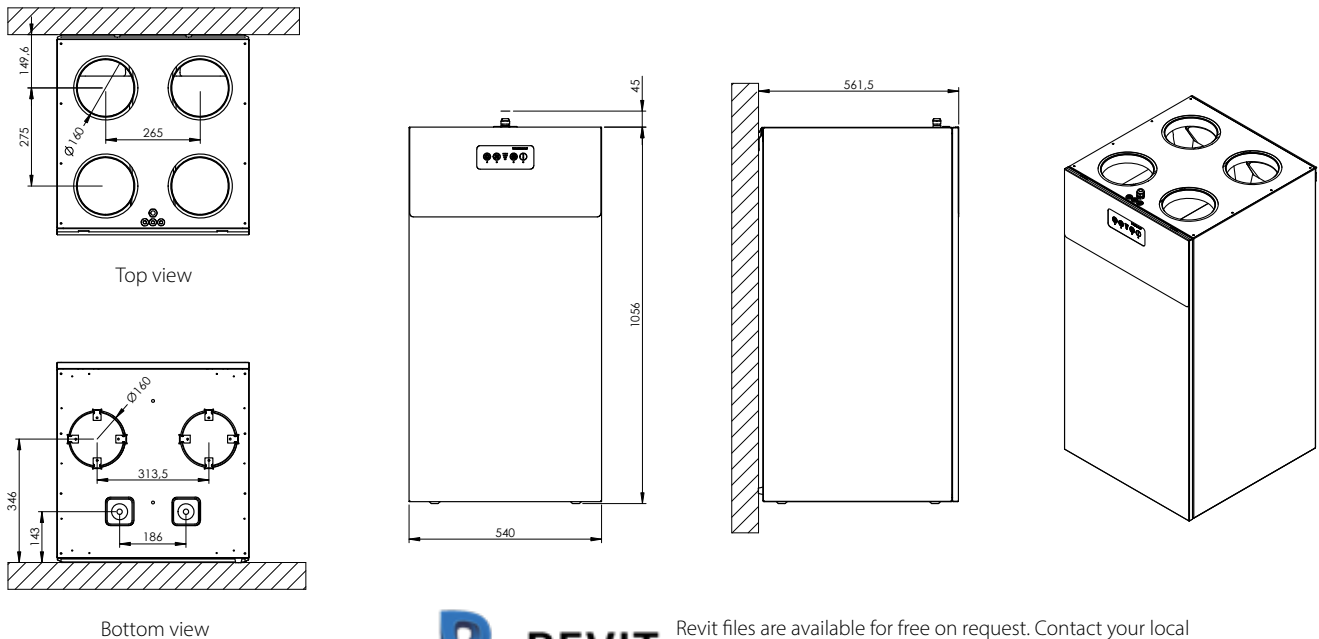

DUCT CONNECTIONS

2 set-up in 1 unit, easy change on site

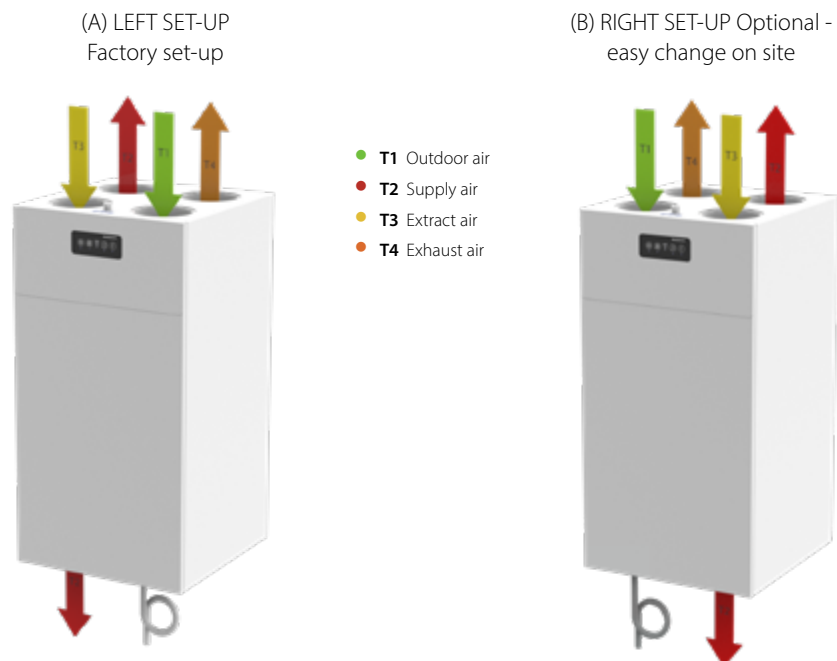

On the HCV 460 it is possible to connect the supply duct to the bottom if the ducts are to run beneath the floor

WALL-MOUNTED UNITS

HCV 460_{E1}



The HCV 460_{E1} is a highly efficient residential ventilation unit for houses, villas, and apartments of up to 450m² or more. It comes supplied as a packaged basic ventilation unit complete with built-in control panel, and is delivered with all parts necessary for wall installation. All HCV 460 units also fit perfectly in a 60 x 60cm cupboard.

The HCV 460 comes in Aluzinc. The units will be delivered on pallets of four to reduce packaging and shipping costs. This makes it ideal for large-scale projects.



- Demand-controlled ventilation with integrated humidity sensor, reducing power consumption at times with low ventilation demands
- Summer mode in which supply fan is stopped and any open window will supply cooler outside air, lowering the room temperature
- Automatic free-cooling features via inbuilt 100% bypass, including the possibility of increasing the air flow automatically, lets in cool night air following hot days to help maintain a comfortable temperature throughout the day
- Fireplace mode, creating a temporary inside overpressure to enhance chimney functionality
- High-efficiency heat recovery
- EC fan motors with extremely low energy consumption (low SPI)
- Easy-to-install and commission solution with built-in air pressure spigots for easy calibration
- Highly customisable units with the option to add a high variety of internal as well as external accessories
- The HCV 460 takes up only as little space as a 60 x 60cm cupboard

WALL-MOUNTED UNITS

HCV 460_{E1}

TECHNICAL DATA

Specifications	Units		HCV 460 _{E1}
Max. flow	V100Pa	m ³ /h	460
Max. rated flow	V _{maxrated}	m ³ /h	360
EN 13141-7 reference flow at 50Pa	V _{ref}	m ³ /h	252
Performance			
Thermal efficiency in accordance with EN13141-7	η_{SUP}	%	77
Leakage (external and internal) in accordance with EN13141-7		%	<2% (Class A1)
Filters in accordance with ISO16890	-	-	ISO Coarse 75% (optional on supply: ePM1>50%)
Filters in accordance with EN779			G4 (optional on supply: F7)
Installation surrounding temperature	t _{SURR}	°C	+12 to +50
Outdoor temperature without preheater installed	t _{ODA}	°C	-12 to +50
Outdoor temperature with preheater installed	t _{ODA}	°C	-20 to +50
Maximum absolute humidity in extract air	x	g/kg	10
Cabinet			
Exterior dimensions without wall brackets	w x h x d	mm	540 x 549 x 1050
Spigots/duct connections	Ø	mm	160 – female
Weight		kg	40
Heat conductivity – polystyrene insulation	λ	W/mK	0.031
Heat transfer coefficient of the polystyrene insulation	U	W/m ² K	U<1
Fire classification of the polystyrene insulation	class		"DIN 4102-1 class B2 EN 13501 class E"
Drainage hose (included)	Ø/length	"/m	¾/1
Cabinet colour	RAL	-	9016
Electrical			
Voltage	U	V	230
Maximum power consumption without/with preheater	P	W	230/2,080
Frequency	f	Hz	50
Protection class	-	-	IP21

* The use of preheating coil is recommended at outdoor temperature -3°C to ensure balanced operation.

** +20mm fitting.

CAPACITY AND SPI CURVES WITH G4/G4 FILTERS

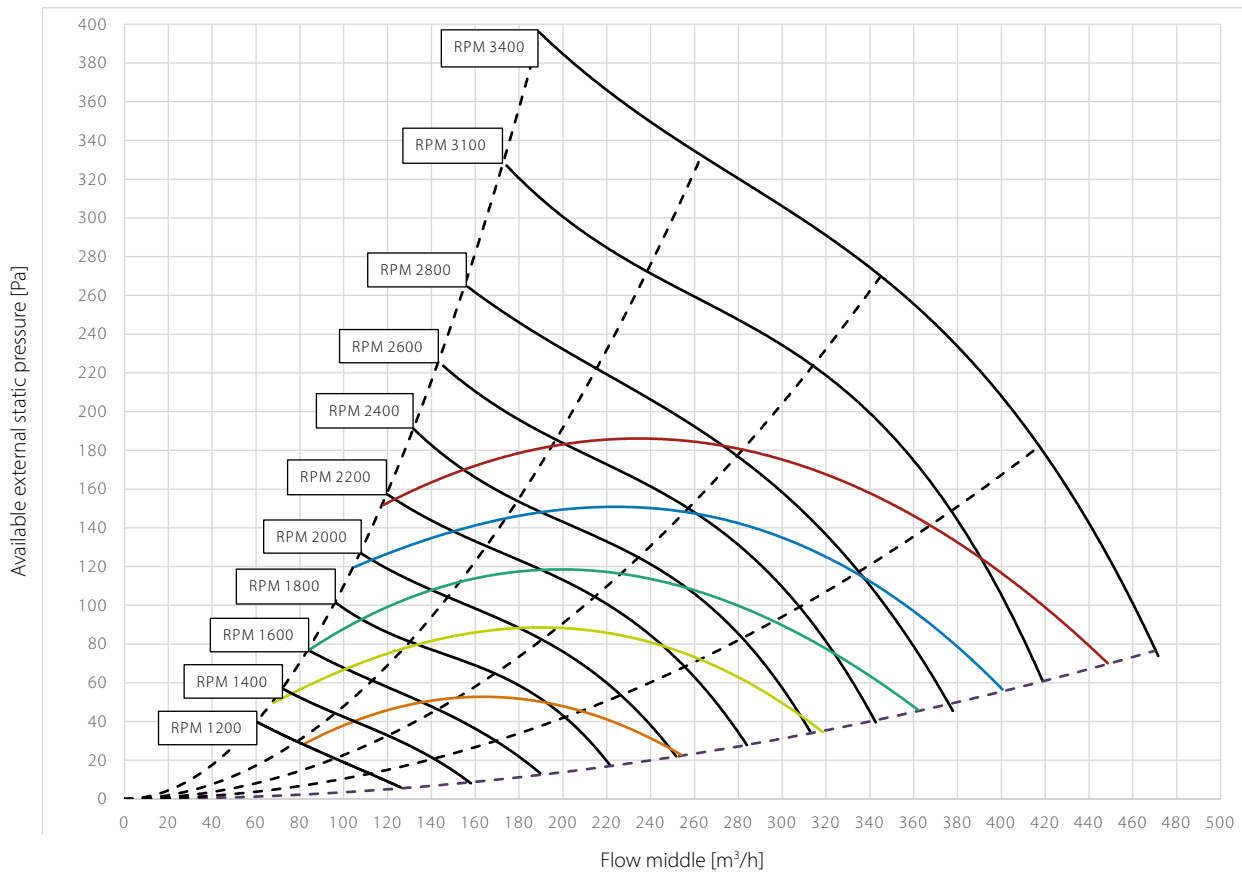

	0.45 W/m ³ /h	0.39 W/m ³ /h	0.33 W/m ³ /h	0.28 W/m ³ /h	0.22 W/m ³ /h
SFP/SPI/SEL*	1620 J/m ³	1400 J/m ³	1200 J/m ³	1000 J/m ³	800 J/m ³
	1.62 W/l/s	1.40 W/l/s	1.20 W/l/s	1.0 W/l/s	0.80 W/l/s

* SFP/SPI/SEL includes power consumption of both fans and the control.

THERMAL EFFICIENCY CURVES

Legend

- Thermal efficiency according to EN 13141-7 (dry)
Operational conditions: outdoor air: 7°C, 85% RH; extract air: 20°C, 38% RH
- Humidity efficiency according to EN 13141-7 (with condensation)
Operational conditions: outdoor air: 2°C, 88% RH; extract air: 20°C, 60% RH

All values at balanced flow

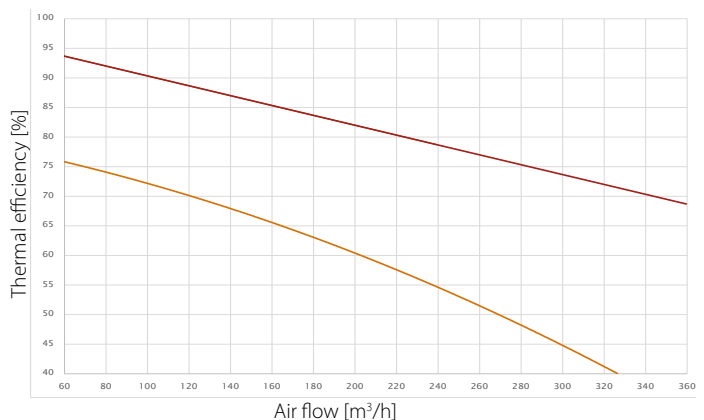

WALL-MOUNTED UNITS

HCV 460_{E1}

SOUND POWER LEVEL (L_w) – DUCTS

RPM	Duct	[dB(A)]								
		63Hz	125Hz	250Hz	500Hz	1kHz	2kHz	4kHz	8kHz	Total
1200	supply/exhaust	28.6	31.3	32.3	32.3	26.8	23.0	11.7	14.5	37
	extract/outdoor	28.0	38.1	38.1	37.5	30.6	29.4	15.5	16.4	43
1300	supply/exhaust	30.5	31.8	34.2	34.1	28.5	24.6	14.5	17.9	39
	extract/outdoor	29.4	39.7	39.8	39.5	32.3	31.7	19.0	19.0	45
1400	supply/exhaust	31.4	32.2	36.1	36.2	30.4	27.1	16.6	18.3	41
	extract/outdoor	30.6	39.3	41.2	41.2	33.7	33.5	20.2	20.4	46
1500	supply/exhaust	32.8	33.0	38.7	38.2	32.3	29.3	18.2	19.6	43
	extract/outdoor	31.8	39.0	43.5	43.1	35.4	35.3	22.3	21.6	48
1600	supply/exhaust	33.6	33.7	40.3	39.7	33.8	31.1	20.3	20.4	44
	extract/outdoor	33.3	38.7	46.1	44.8	37.0	37.2	25.1	22.1	49
1700	supply/exhaust	34.2	34.2	43.3	41.4	35.2	32.6	20.9	21.0	46
	extract/outdoor	34.0	39.2	48.8	46.1	38.3	38.7	26.6	22.6	51
1800	supply/exhaust	33.7	32.8	44.1	43.1	36.9	34.5	22.7	21.6	47
	extract/outdoor	35.2	39.7	52.0	47.2	39.8	40.1	28.7	23.0	54
1900	supply/exhaust	34.8	34.0	45.4	44.5	38.3	36.1	24.6	22.1	49
	extract/outdoor	35.9	40.1	52.4	47.9	40.7	41.2	30.1	23.4	54
2000	supply/exhaust	35.7	34.8	47.0	45.2	39.5	37.2	25.4	23.0	50
	extract/outdoor	37.2	40.8	55.2	48.3	42.1	42.6	31.7	23.8	57
2100	supply/exhaust	36.6	35.3	48.3	46.1	40.8	38.4	26.7	23.8	51
	extract/outdoor	38.1	41.6	56.0	49.2	43.3	43.7	33.2	24.6	57
2200	supply/exhaust	38.4	37.1	50.0	47.1	42.3	39.8	28.6	24.1	53
	extract/outdoor	38.5	42.7	58.5	50.3	44.6	44.9	34.7	27.0	59
2300	supply/exhaust	38.9	37.9	52.6	48.4	43.6	41.0	30.2	24.5	55
	extract/outdoor	39.4	43.3	60.8	51.4	45.4	45.7	35.7	27.8	62
2400	supply/exhaust	39.9	38.7	52.8	49.6	44.6	42.1	31.6	24.7	55
	extract/outdoor	40.4	44.1	60.0	52.7	46.6	46.8	37.0	29.5	61
2500	supply/exhaust	41.0	39.4	53.4	50.6	45.6	43.0	32.7	25.6	56
	extract/outdoor	41.1	45.0	59.3	54.4	47.5	47.7	38.2	30.8	61
2600	supply/exhaust	42.5	40.3	54.0	52.0	46.7	44.0	33.9	27.3	57
	extract/outdoor	42.3	45.5	60.5	56.3	48.6	48.7	39.2	32.2	62
2700	supply/exhaust	42.5	41.0	54.7	53.6	47.6	44.8	34.9	27.6	58
	extract/outdoor	42.4	46.3	62.3	58.3	49.6	49.4	40.1	33.1	64

SOUND PRESSURE LEVEL (L_p) – CABINET**1m distance**

RPM	[dB(A)]								
	63Hz	125Hz	250Hz	500Hz	1kHz	2kHz	4kHz	8kHz	Total
1200	-	-	12.9	19.5	21.5	21.9	18.0	10.3	27
1400	-	5.7	18.5	23.8	23.5	23.5	18.5	10.6	29
1600	-	6.0	22.1	26.9	26.3	27.6	18.8	11.0	32
1800	-	6.9	25.3	29.4	28.2	28.3	20.6	12.0	34
2000	-	7.6	27.8	31.2	30.7	30.5	22.6	14.3	36
2200	-	8.0	31.3	33.3	32.6	32.8	24.8	17.4	39
2600	-	10.5	31.3	38.2	37.0	36.9	29.7	22.8	43
3000	-	13.1	31.4	43.1	40.2	40.0	33.0	26.1	47
3400	-	16.7	33.8	49.7	44.5	43.3	36.5	29.8	52

2m distance

RPM	[dB(A)]								
	63Hz	125Hz	250Hz	500Hz	1kHz	2kHz	4kHz	8kHz	Total
1200	-	-	8.7	18.6	21.5	21.9	18.0	10.3	27
1400	-	-	12.7	22.1	22.8	22.8	18.5	10.6	28
1600	-	-	16.9	25.3	25.5	24.9	18.8	11.0	31
1800	-	2.1	20.0	28.6	27.2	26.4	20.6	12.0	33
2000	-	3.5	22.9	30.9	29.4	28.5	21.7	13.6	35
2200	-	5.0	26.4	32.6	31.4	30.1	23.2	15.3	37
2600	-	8.1	27.3	37.2	36.3	33.8	27.1	19.9	41
3000	-	11.0	30.0	43.1	39.1	37.2	30.7	23.6	46
3400	-	14.0	30.9	49.7	42.7	41.6	34.1	27.1	51

WALL-MOUNTED UNITS

HCV 460_{E1}

DIMENSIONS

On the HCV 460 it is possible to connect the supply duct to the bottom if the ducts are to run beneath the floor.

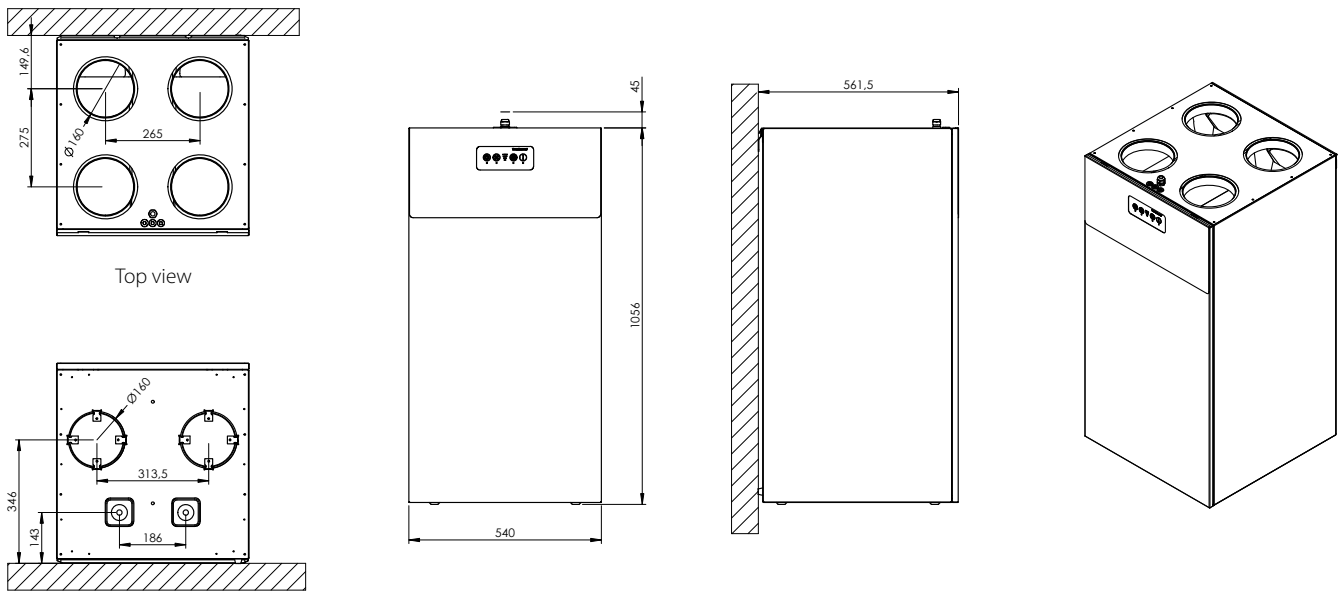

Revit files are available for free on request. Contact your local supplier or Dantherm for access.

DUCT CONNECTIONS

2 set-up in 1 unit, easy change on site

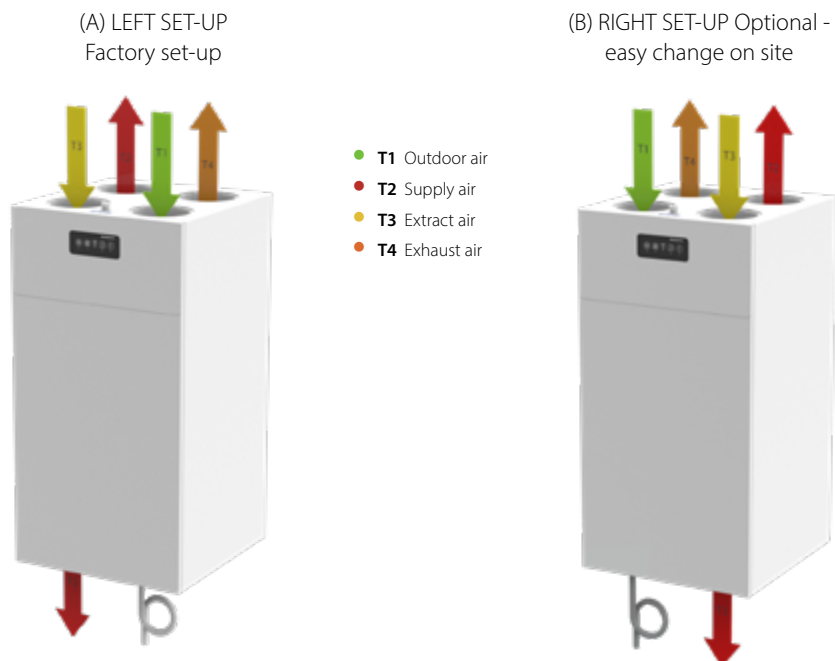

On the HCV 460 it is possible to connect the supply duct to the bottom if the ducts are to run beneath the floor

WALL-MOUNTED UNITS

HCV 500



The HCV 500 is a highly efficient residential ventilation unit for houses, villas, and apartments of up to 450m² or more. It comes supplied as a packaged basic ventilation unit complete with built-in control panel, and are delivered with all parts necessary for wall installation. The HCV 500 is ideal for free wall installation with minimum 700mm space. A standard wall rail is supplied with all units.

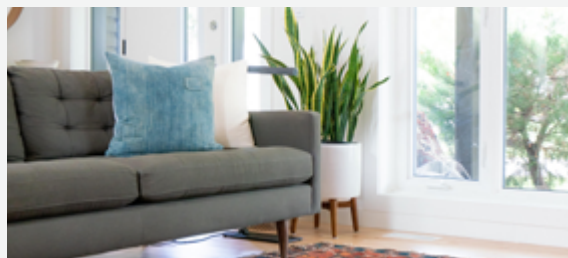

- Demand-controlled ventilation with integrated humidity sensor, reducing power consumption at times with low ventilation demands
- Summer mode in which supply fan is stopped and any open window will supply cooler outside air, lowering the room temperature
- Automatic free-cooling features via inbuilt 100% bypass, including the possibility of increasing the air flow automatically, lets in cool night air following hot days to help maintain a comfortable temperature throughout the day
- Fireplace mode, creating a temporary inside overpressure to enhance chimney functionality
- High-efficiency heat recovery
- EC fan motors with extremely low energy consumption (low SPI)
- Easy-to-install and commission solution with built-in air pressure spigots for easy calibration
- Highly customisable units, with option a high variety of internal as well as external accessories
- A standard wall rail is supplied with the unit

Third party testing and certifications

Code	Description
DIBt	Certified by the German Institute of Construction Technology
EPB	Listed in the database for Energy Performance of Buildings in Belgium
ErP	Compliant with EU regulations for Eco-design
Nordic Swan Ecolabel	Listed in the Nordic Swan database for products suitable for Ecolabelled buildings

WALL-MOUNTED UNITS

HCV 500

TECHNICAL DATA

Specifications	Units		HCV 500
Max. flow	V100Pa	m ³ /h	400
Max. rated flow	Vmax.rated	m ³ /h	300
Recommended operating range	V	m ³ /h	70 - 300
EN 13141-7 reference flow at 50Pa	V _{ref}	m ³ /h	210
Performance			
Thermal efficiency in accordance with EN13141-7	η_{SUP}	%	86
Specific power consumption in accordance with EN13141-7	SFP	W/m ³ /h	0.21
Leakage (external and internal) in accordance with EN13141-7	-	%	<2% (Class A1)
Filters in accordance with ISO16890	-	-	ISO Coarse 75% (optional on supply: ePM1 >50%)
Filters in accordance with EN779	-	-	G4 (optional on supply: F7)
Installation ambient temperature	t _{SURR}	°C	+12 to +50
Outdoor temperature range without preheater installed	t _{ODA}	°C	-12* to +50
Outdoor temperature range with preheater installed	t _{ODA}	°C	-20 to +50
Maximum absolute humidity in extract air	x	g/kg	10
Cabinet			
Dimensions (without wall bracket)	w x d x h	mm	700 x 603 x 1050
Spigots/duct connections	Ø	mm	160 – female
Weight		kg	49.5
Thermal conductivity – polystyrene insulation	λ	W/mK	0.031
Heat transition figures – polystyrene insulation	U	W/m ² K	<1
Fire classification of the polystyrene insulation	-	-	DIN 4102-1 class B2 EN 13501 class E
Drainage hose	Ø/length	"/m	¾ / 1
Cabinet colour	RAL	-	9016
Electrical			
Voltage	U	V	230
Maximum power consumption (without/with preheater)	P	W	170/1370
Frequency	f	Hz	50
Protection class	-	-	IP21

*The use of the preheating coil is recommended at outdoor temperature below -3°C to ensure balanced operation.

WALL-MOUNTED UNITS HCV 500

CAPACITY AND SPI CURVES WITH G4/G4 FILTERS

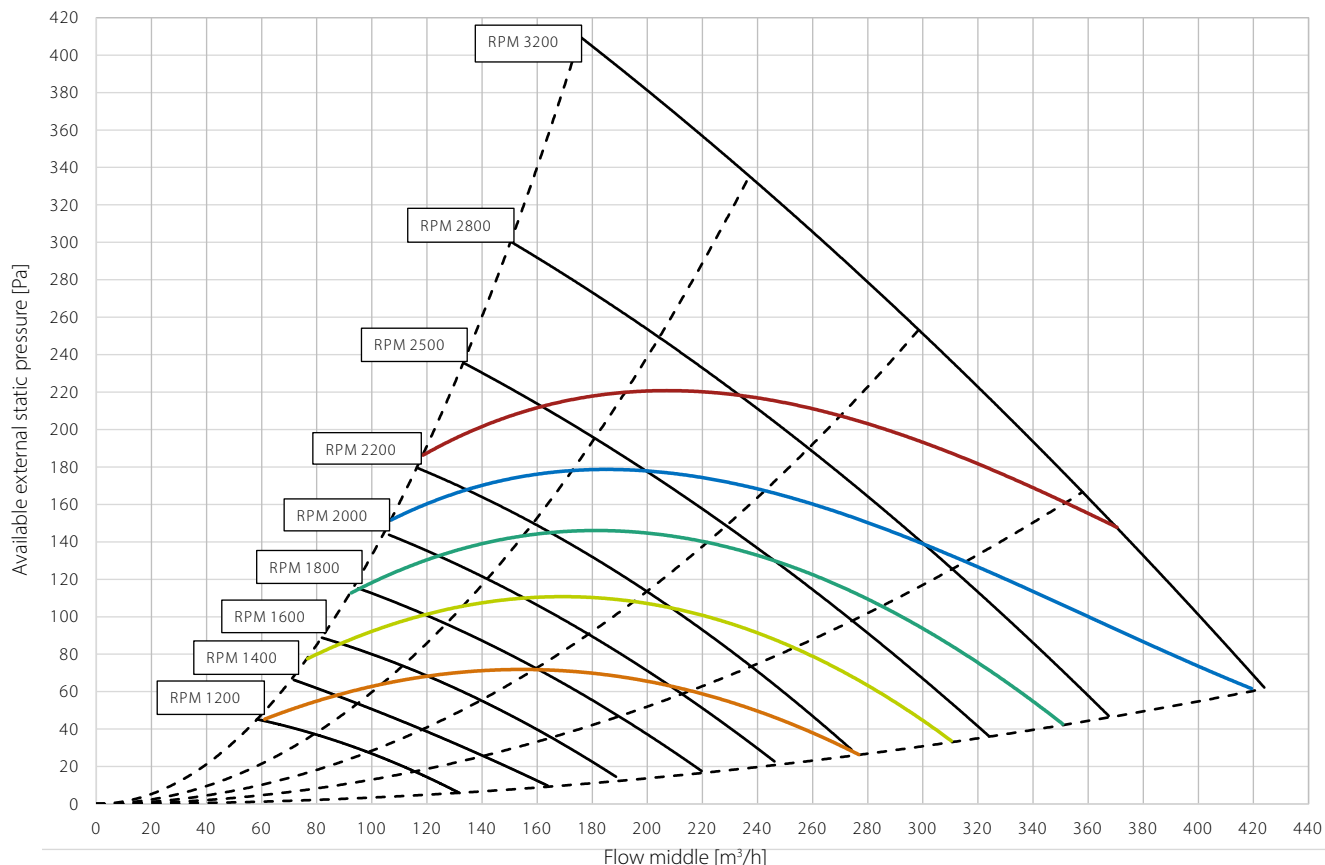

	Red	Blue	Green	Yellow	Orange
SFP/SPI/SEL*	0.45 W/m ³ /h	0.39 W/m ³ /h	0.33 W/m ³ /h	0.28 W/m ³ /h	0.22 W/m ³ /h
	1620 J/m ³	1400 J/m ³	1200 J/m ³	1000 J/m ³	800 J/m ³
	1.62 W/l/s	1.40 W/l/s	1.20 W/l/s	1.0 W/l/s	0.80 W/l/s

* SFP/SPI/SEL includes power consumption of both fans and the control.

THERMAL EFFICIENCY CURVES

Legend

- Thermal efficiency according to EN 13141-7 (dry)
Operational conditions: outdoor air: 7°C, 88% RH; extract air: 20°C, 38% RH
- Thermal efficiency according to EN 13141-7 (with condensation)
Operational conditions: outdoor air: 2°C, 87% RH; extract air: 20°C, 60% RH

All values at balanced flow

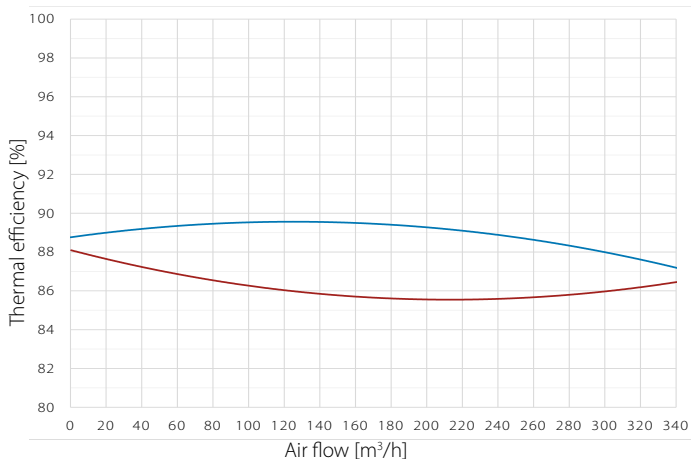

WALL-MOUNTED UNITS

HCV 500

SOUND DATA WITH G4/G4 FILTERS

Air volume m ³ /h	Pres- sure Pa	Operational point	Frequency band sound power Lw(A) dB(A)								Total sound power Lw(A) dB(A)	Sound pressure standard room* Lp(A) dB(A)
			63Hz	125Hz	250Hz	500Hz	1000Hz	2000Hz	4000Hz	8000Hz		
230	100	Supply air	41	44	52	49	42	37	29	22	55	
		Extract air	49	50	59	54	46	44	37	27	61	
		Cabinet	30	41	46	48	42	37	25	19	51	46

*Standard room = room with 10m² floor, 2.4m ceiling height, mean absorption 0.2

DIMENSIONS

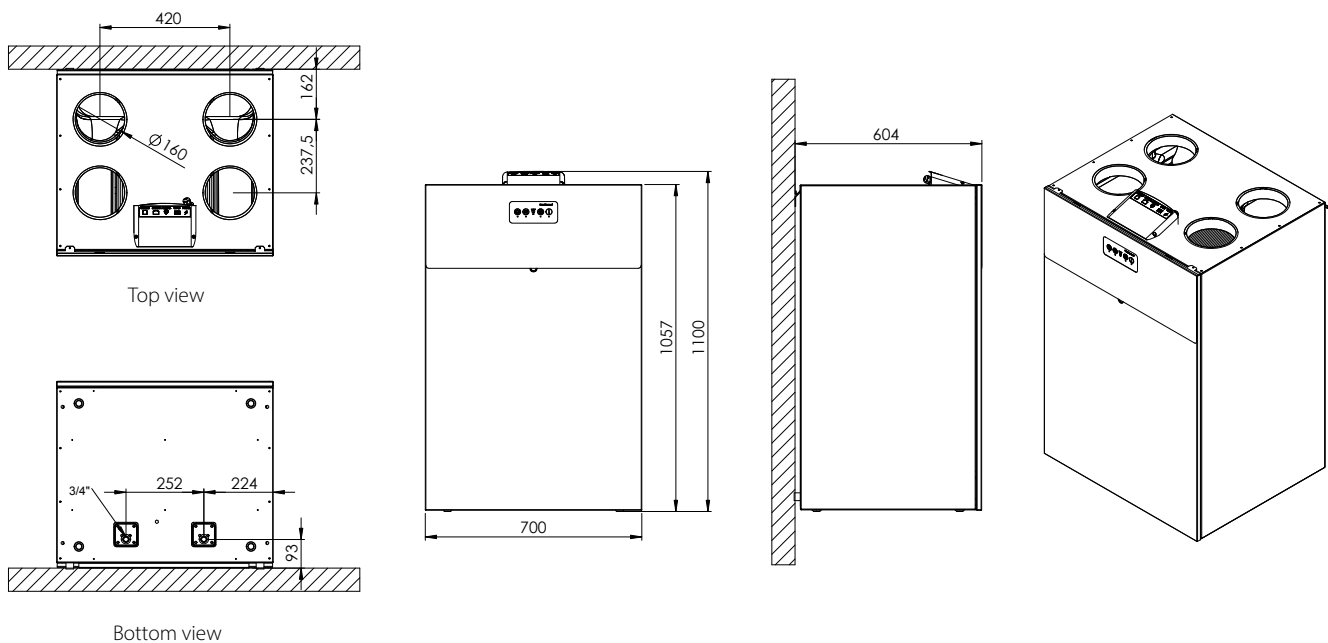

Revit files are available for free on request. Contact your local supplier or Dantherm for access.

WALL-MOUNTED UNITS

HCV 700



The HCV 700 is a highly efficient residential ventilation unit for houses, villas, and apartments of up to 450m² or more. It comes supplied as a packaged basic ventilation unit complete with built-in control panel, and are delivered with all parts necessary for wall installation. The HCV 700 is ideal for free wall installation with minimum 700mm space. A standard wall rail is supplied with all units.



- Demand-controlled ventilation with integrated humidity sensor, reducing power consumption at times with low ventilation demands
- Summer mode, in which supply fan is stopped and any open window will supply cooler outside air, lowering the room temperature
- Automatic free-cooling features via inbuilt 100% bypass, including the possibility of increasing the air flow automatically, lets in cool night air following hot days to help maintain a comfortable temperature throughout the day
- Fireplace mode, creating a temporary inside overpressure, to enhance chimney functionality
- High-efficiency heat recovery
- EC fan motors with extremely low energy consumption (low SPI)
- Easy-to-install and commission solution with built-in air pressure spigots for easy calibration
- Highly customisable units, with the option to add a high variety of internal as well as external accessories
- A standard wall rail is supplied with the unit

Third party testing and certifications

Code	Description
DIBt	Certified by the German Institute of Construction Technology
EPB	Listed in the database for Energy Performance of Buildings in Belgium
ErP	Compliant with EU regulations for Eco-design
Nordic Swan Ecolabel	Listed in the Nordic Swan database for products suitable for Ecolabelled buildings

WALL-MOUNTED UNITS

HCV 700

TECHNICAL DATA

Specifications	Units		HCV 700
Max. flow	V100Pa	m ³ /h	550
Max. rated flow	V _{max.rated}	m ³ /h	450
Recommended operating range	V	m ³ /h	80 - 450
EN 13141-7 reference flow at 50Pa	V _{ref}	m ³ /h	315
Performance			
Thermal efficiency in accordance with EN13141-7	η_{SUP}	%	85
Specific power consumption in accordance with EN13141-7	SFP	W/m ³ /h	0.22
Leakage (external and internal) in accordance with EN13141-7	-	%	<2% (Class A1)
Filters in accordance with ISO16890	-	-	ISO Coarse 75% (optional on supply: ePM1>50%)
Filters in accordance with EN779	-	-	G4 (optional on supply: F7)
Installation ambient temperature	t _{surp}	°C	+12 to +50
Outdoor temperature range without preheater installed	t _{ODA}	°C	-12* to +50
Outdoor temperature range with preheater installed	t _{ODA}	°C	-20 to +50
Maximum absolute humidity in extract air	x	g/kg	10
Cabinet			
Dimensions (without wall bracket)	w x d x h	mm	700 x 750 x 1050
Spigots/duct connections	Ø	mm	200 – female
Weight		kg	70
Thermal conductivity – polystyrene insulation	λ	W/mK	0.031
Heat transition figures – polystyrene insulation	U	W/m ² K	<1
Fire classification of the polystyrene insulation	-	-	DIN 4102-1 class B2 EN 13501 class E
Drainage hose	Ø/length	"/m	¾ / 1
Cabinet colour	RAL	-	9016
Electrical			
Voltage	U	V	230
Maximum power consumption (without/with preheater)	P	W	234/1,834
Frequency	f	Hz	50
Protection class	-	-	IP21

*The use of the preheating coil is recommended at outdoor temperature below -3°C to ensure balanced operation.

WALL-MOUNTED UNITS HCV 700

CAPACITY AND SPI CURVES WITH G4/G4 FILTERS

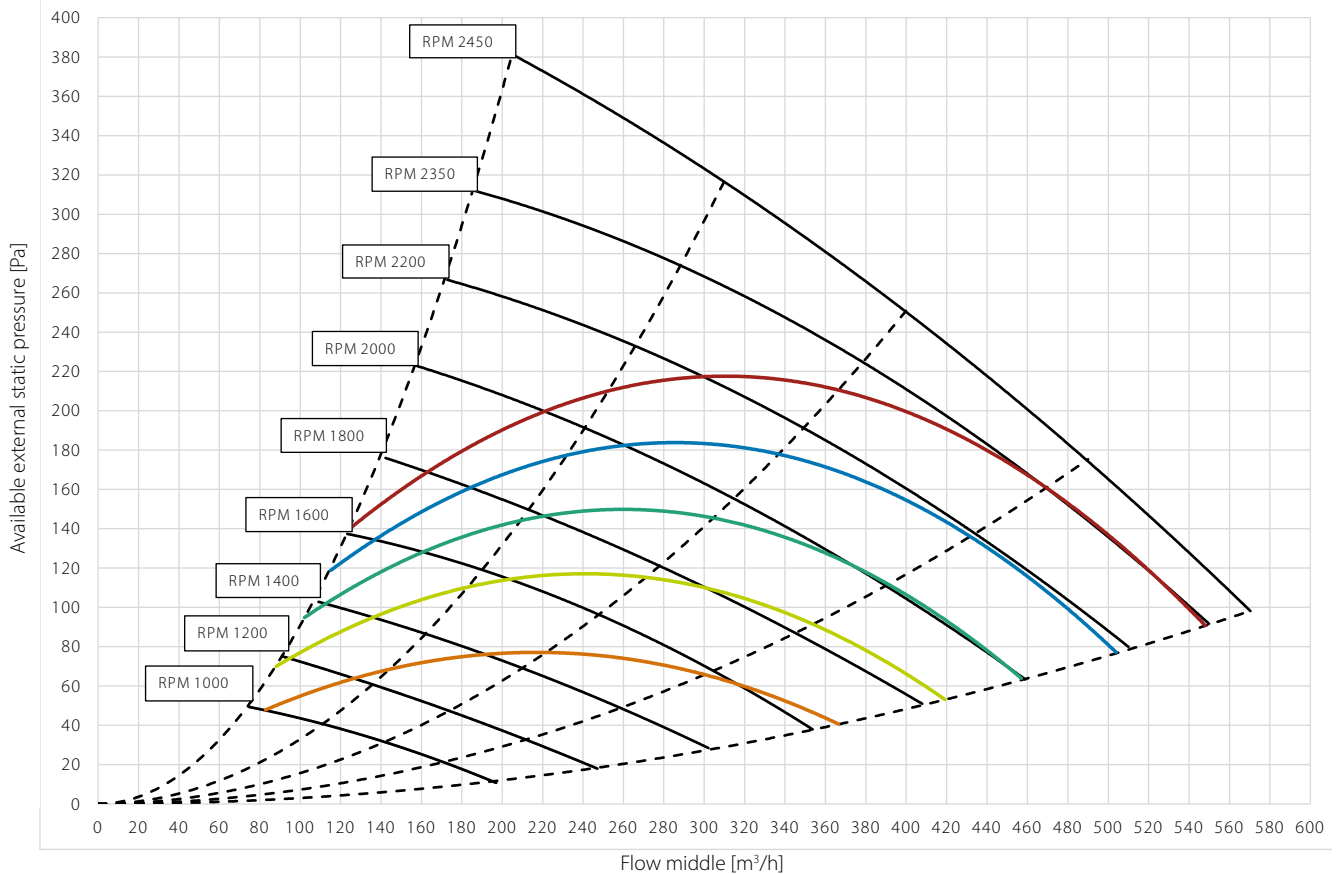

	Red	Blue	Green	Yellow	Orange
SFP/SPI/SEL*	0.45 W/m ³ /h	0.39 W/m ³ /h	0.33 W/m ³ /h	0.28 W/m ³ /h	0.22 W/m ³ /h
	1620 J/m ³	1400 J/m ³	1200 J/m ³	1000 J/m ³	800 J/m ³
	1.62 W/l/s	1.40 W/l/s	1.20 W/l/s	1.0 W/l/s	0.80 W/l/s

* SFP/SPI/SEL includes power consumption of both fans and the control.

THERMAL EFFICIENCY CURVES

Legend

- Thermal efficiency according to EN 13141-7 (dry)
Operational conditions: outdoor air: 7°C, 85% RH; extract air: 20°C, 37% RH
- Thermal efficiency according to EN 13141-7 (with condensation)
Operational conditions: outdoor air: 2°C, 87% RH; extract air: 20°C, 60% RH

All values at balanced flow

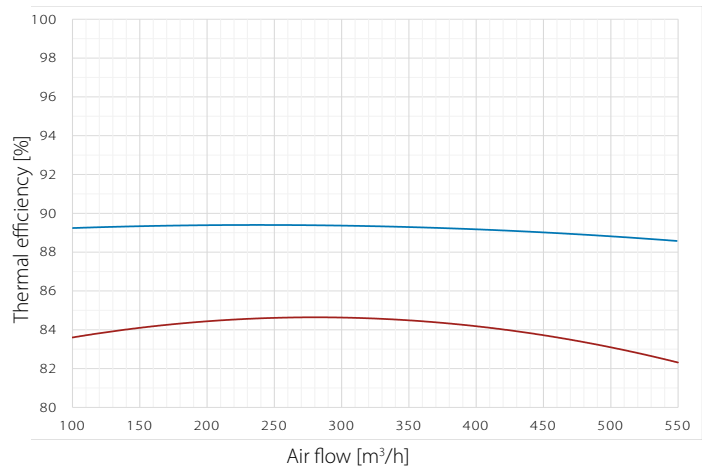

WALL-MOUNTED UNITS

HCV 700

SOUND DATA WITH G4/G4 FILTERS

Air volume m ³ /h	Pres- sure Pa	Operational point	Frequency band sound power Lw(A) dB(A)								Total sound power Lw(A) dB(A)	Sound pressure standard room* Lp(A) dB(A)
			63Hz	125Hz	250Hz	500Hz	1000Hz	2000Hz	4000Hz	8000Hz		
350	100	Supply air	54	55	64	57	53	45	35	27	65.5	
		Extract air	63	62	68	63	56	52	44	34	71.1	
		Cabinet	36	45	55	52	50	43	28	20	57.8	53

DIMENSIONS

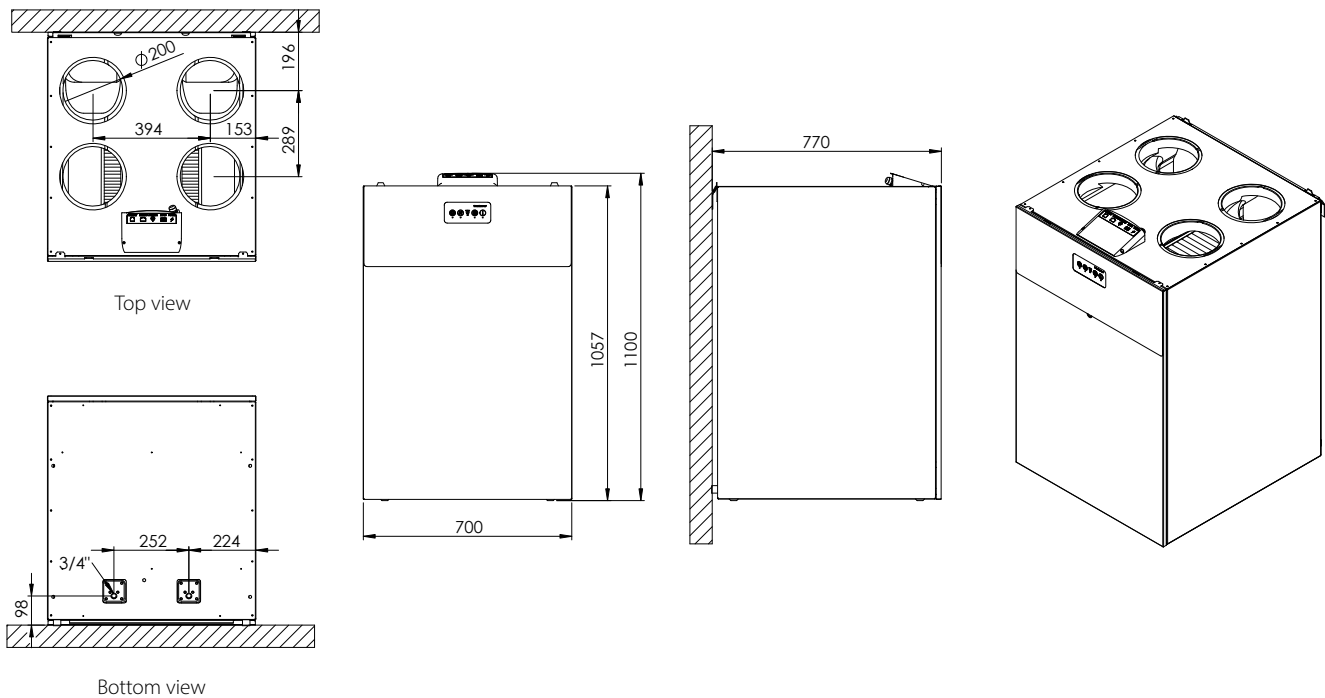

Revit files are available for free on request. Contact your local supplier or Dantherm for access.

CEILING- AND WALL-MOUNTED



ENERGY-EFFICIENT VENTILATION SOLUTIONS FOR: HOMES, APARTMENTS, NEW-BUILDS AND RENOVATIONS

QUICK GUIDE



HCC 2 PLA



HCC 260_{F1}



HCC 360_{F2}
HCC 360_{E1}

INSTALLATION



WALL-MOUNTED



ATTIC-MOUNTED



CEILING

	HCC 2 PLA	HCC 260 _{F1}	HCC 360 _{F2} HCC 360 _{E1}
WALL-MOUNTED	●	●	●
ATTIC-MOUNTED			
CEILING	●	●	●

CEILING AND WALL-MOUNTED HCC RANGE



PAINTED IN RAL 9016

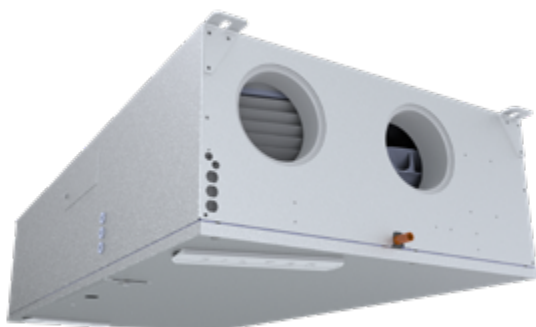

SURFACE IN ALUZINC

Model range

The HCC range is available in a variant with an Aluzinc surface, standard filter resetting capability as well as easy PCB access to connect accessories. Delivered four units on a pallet at a time, it also minimises the use of packaging in consideration of the environment.

Overview

The HCC residential ventilation unit is primarily designed for new constructions or retrofitting into multiple apartment buildings. The outer dimensions and design allow easy installation into a suspended ceiling or onto a wall, hidden inside a closet.

The unit is supplied as a basic unit, with the option of fitting a wide range of accessories into the unit, thus extending the comfort and reducing the energy consumption.

The residential ventilation unit is equipped with a highly efficient plastic counter-flow heat exchanger, which is optimised to a high efficiency level. This, combined with a low headroom, results in a very slim ventilation unit, easily hidden in a suspended ceiling, together with the duct system.

HCC enclosure

The unit enclosure is designed to fit low headroom suspended ceilings, and yet still with easy service access. The outer surface is 0.8mm Aluzinc powder coated sheet, which comes in options painted with white in RAL 9010 or not, with two external lids covering the two filter slots.

All inside air paths and insulation, is made of EPS (Polystyrene). This has a high insulation level, and good air tightness, which permits location of the units in spaces with temperatures down to +12°C.

Because of their ability to be either ceiling- or wall-mounted, the units will fit into almost any residential area without being visible.

Function

The unit ventilates residential homes by extracting the inside humid air, and replacing it with fresh outside air, which has been heated with the heat energy of the extracted air. This reduces energy consumption.



CEILING AND WALL-MOUNTED HCC RANGE

When very humid inside air is extracted, the humidity will condensate inside the heat exchanger, and be collected by the embedded drip tray. This water is drained from the unit through the enclosed hose and then disposed of in the nearest drainage.

Mirroring all duct connections

The air flow direction can be electronically swapped, providing ability to route the connected ducts, either to the right or to the left. This means that the supply air duct connections can be either to the right or to the left hand side of the unit. (Supply air and extract air duct connections always towards the inside of the house and outside air and exhaust air ducts always towards the outside of the house).

All electrical cables can be connected from either the left or the right hand side, regardless of fan direction.

Filters

Requiring no tools, users can change the filter on their own and then reset the filter timer using the standard filter resetting button (HCC 260 and HCC 360) or the optional HCP 11 wired control. If no controls are available, the filter is to be changed by an installer with the appropriate PC Tool on his laptop for resetting the filter timer.

Apart from changing the air filters and cleaning the outside of the unit, any other form of service will have to be carried out by qualified personnel. Local Dantherm technicians and Dantherm partners are always available to solve any problem with the unit that might arise.

Removing the front cover gives access to all types of service and repair.

Installation parts

The enclosed mounting bracket is designed to conduct a safe installation process, and is suitable for both wall and ceiling installation.

The mounting bracket will tilt the unit slightly towards the drainage spigot, ensuring correct drainage of any condensed water inside the unit when used for ceiling installation. It will also offer a easy wall installation process.

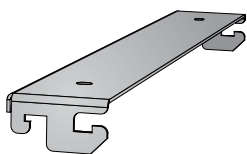

**UNIVERSAL
MOUNTING
BRACKET**



FILTER CHANGE



**ILLUSTRATION OF DUCT CONNECTIONS
IN FAN DIRECTION MODE A**



**ILLUSTRATION OF DUCT CONNECTIONS
IN FAN DIRECTION MODE B**

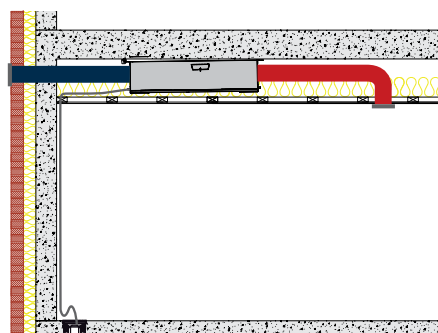

HCC 2 IN SUSPENDED CEILING

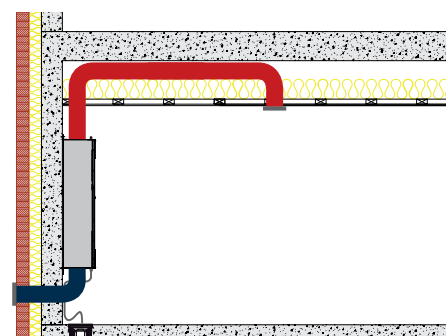

HCC 2 ON WALL

CEILING AND WALL-MOUNTED HCC 2_{PLA}



The HCC 2 is a unique and flexible residential ventilation solution. With only 30cm installation headroom it is ideal for installation in suspended ceilings or onto a wall, even hidden inside a closet. The unit can be electronically reversed, meaning that both air flows will be reversed. This allows the same unit type to be mounted with the inside/outside ducts connected to either the right or the left hand side of the unit. Electrical connections can be connected from either the left or the right.



- High efficiency heat recovery – up to 94%
- EC fan motors with low energy consumption (low SPI)
- Only 300mm installation headroom height is required
- Time controlled ventilation level, based on 11 different built-in pre-programmed week programs, reducing power consumption in periods with low ventilation demands
- Summer cooling mode
- Automatic free-cooling features via inbuilt 100% bypass, including the possibility of increasing the air flow automatically, lets in cool night air following hot days to help maintain a comfortable temperature throughout the day
- Fireplace mode, creating a momentary inside overpressure, to enhance chimney functionality
- Easy-to-install and commissioning solution with built in air measure ports, for easy balancing with PC Tool
- Electronically left/right fan direction switching, allowing same unit type to adapt any physical installation requirements, regardless of ceiling and wall selection
- TCP/IP ModBus connection, for inter-operation with Building Management System
- Electrical connections can be connected from either the left or the right

Third party testing and certifications

Code	Description
PHI	Passivhaus certified
DIBt	Certified by the German Institute of Construction Technology
EPB	Listed in the database for Energy Performance of Buildings in Belgium
ErP	Compliant with EU regulations for Eco-design
Nordic Swan Ecolabel	Listed in the Nordic Swan database for products suitable for Ecolabelled buildings

CEILING AND WALL-MOUNTED HCC 2_{PLA}

TECHNICAL DATA

Specifications	Units		HCC 2 _{PLA}
Max. flow	V100Pa	m ³ /h	260
Max. rated flow at 100Pa	V _{max.rated}	m ³ /h	180
Recommended operating range	V	m ³ /h	50 - 180
Operating range DIBt	V _{DIBt}	m ³ /h	70 to 140
Operating range Passivhaus at 100Pa	V _{PHI}	m ³ /h	70 to 140
EN 13141-7 reference flow at 50Pa	V _{REF}	m ³ /h	126
Performance			
Thermal efficiency DIBt	η _{DIBt}	%	93.8
Thermal efficiency Passivhaus	η _{PHI}	%	93
Thermal efficiency EN 13141-7 at reference flow	η _{EN}	%	94
Filters in accordance with ISO16890	-	-	ISO Coarse 75% (optional on supply: ePM1>50%)
Filters in accordance with EN779	-	-	G4 (optional on supply: F7)
Installation surrounding temperature range	t _{surr}	°C	+12 to +40
Maximum humidity in extract air at 25°C	RH	%	55
Outdoor temperature range without preheating installed	t _{ODA}	°C	-12* to +45
Outdoor temperature range with preheating installed	t _{ODA}	°C	-15 to +45
Cabinet			
Dimensions (without wall bracket)	w x d x h	mm	600 x 279 x 1122
Spigots/duct connections	∅	mm	125 – female
Weight	m	kg	34
Heat conductivity – polystyrene insulation	λ	W/mK	0.031
Heat transfer coefficient – polystyrene insulation	U	W/m ² K	<1
Leakage (external and internal) according to EN 13141-7	class		<2% (Class A1)
Drainage hose (included)	∅	"	1/2
Cabinet colour	RAL	-	9016
Fire classification of the polystyrene insulation	-	-	DIN 4102-1 class B2 EN 13501 class E
Electrical			
Voltage	U	V	230
Maximum power consumption (without/with preheater)	P	W	127/1,027
Frequency	f	Hz	50
Protection class	-	-	IP20

* In order to ensure balanced ventilation, preheater is recommended when outdoor temperature is below -3°C.

CEILING AND WALL-MOUNTED HCC 2_{PLA}

CAPACITY AND SPI CURVES WITH G4/G4 FILTERS

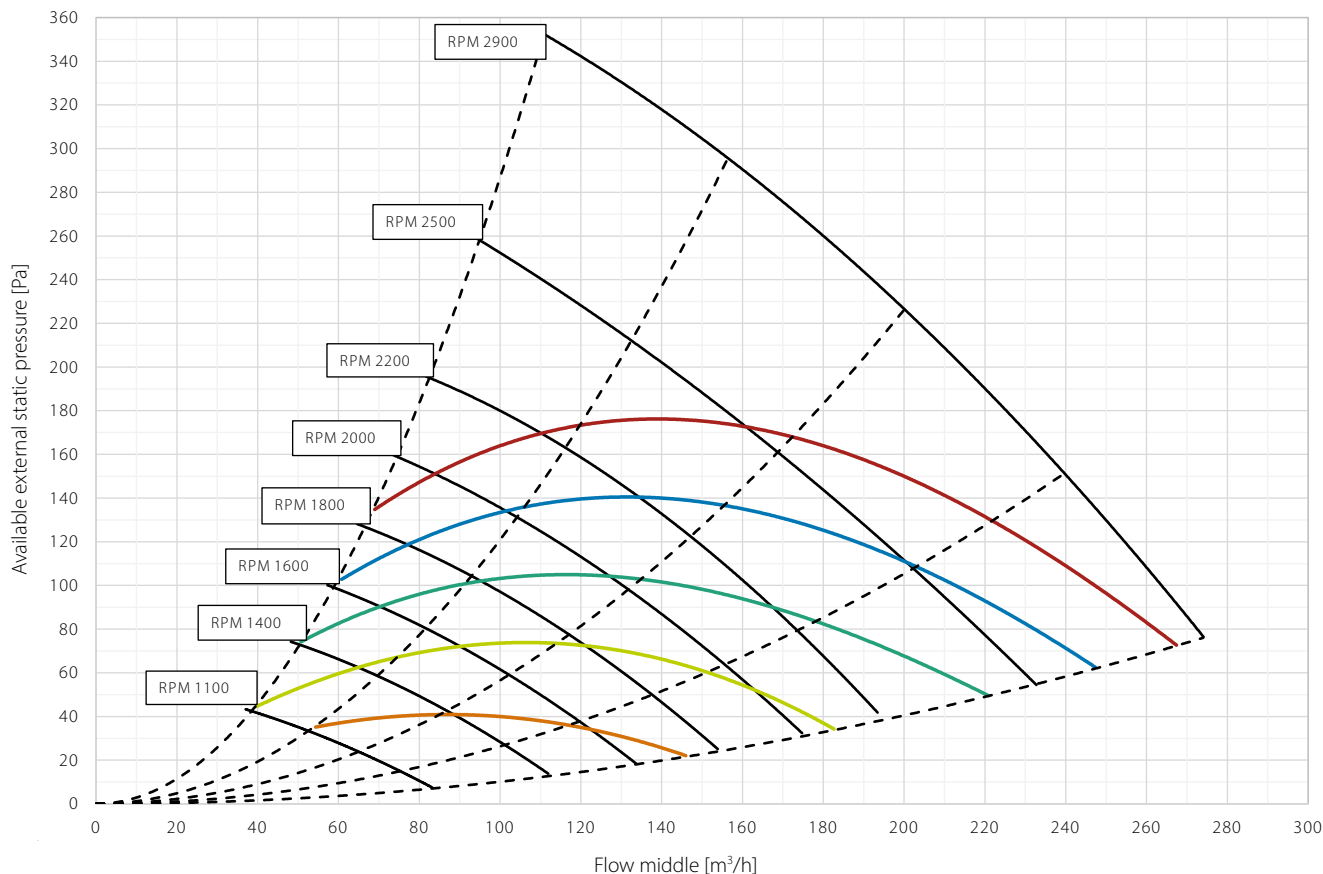

	—	—	—	—	—
SFP/SPI/SEL*	0.45 W/m ³ /h	0.39 W/m ³ /h	0.33 W/m ³ /h	0.28 W/m ³ /h	0.22 W/m ³ /h
	1620 J/m ³	1400 J/m ³	1200 J/m ³	1000 J/m ³	800 J/m ³
	1.62 W/l/s	1.40 W/l/s	1.20 W/l/s	1.0 W/l/s	0.80 W/l/s

* SFP/SPI/SEL includes power consumption of both fans and the control.

THERMAL EFFICIENCY CURVES

Legend

- Thermal efficiency according to EN 13141-7 (dry)
Operational conditions: outdoor air: 7°C, 88% RH; extract air: 20°C, 38% RH
- Thermal efficiency according to EN 13141-7 (with condensation)
Operational conditions: outdoor air: 2°C, 85% RH; extract air: 20°C, 60% RH
- Thermal efficiency according Passivhaus Institut
Operational conditions: outdoor air: 4°C, 94% RH; extract air: 21°C, 30% RH

All values at balanced flow

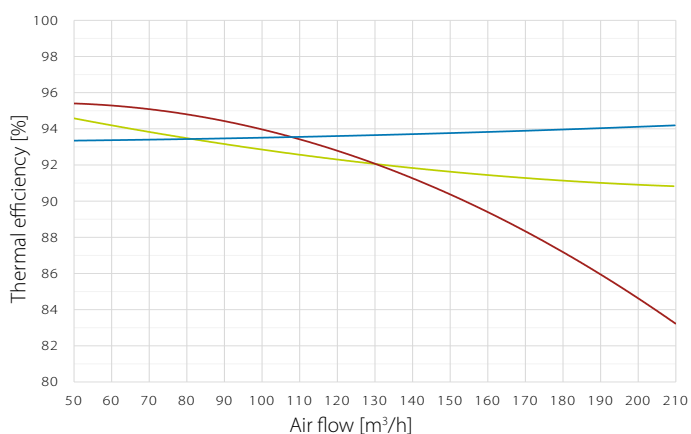

CEILING AND WALL-MOUNTED

HCC 2_{PLA}

SOUND DATA WITH G4/G4 FILTERS

Air-volume m ³ /h	Pres. Pa	Measure point	Frequency band sound power L _w (A) dB(A)								Total sound power L _w (A) dB(A)	Sound pres. L _p (A) Standard room*
			63Hz	125Hz	250Hz	500Hz	1000Hz	2000Hz	4000Hz	8000Hz		
80	30	Supply air	23	43	40	42	39	32	20	18	47	
		Extract air	12	26	24	24	16	16	17	18	30	
		Cabinet									30	25
98	50	Supply air	28	41	51	48	44	39	26	18	54	
		Extract air	16	27	31	29	19	16	17	18	35	
		Cabinet									34	29
100	100	Supply air	32	49	56	52	49	44	33	19	59	
		Extract air	19	31	42	33	23	19	17	18	43	
		Cabinet									37	32
126	70	Supply air	31	43	55	52	49	45	33	19	58	
		Extract air	19	30	42	33	23	19	17	18	42	
		Exhaust air	30	43	54	52	47	43	32	18	57	
		Cabinet									40	35
140	100	Supply air	34	46	56	56	52	49	37	21	60	
		Extract air	21	33	44	36	27	21	18	18	45	
		Exhaust air	33	45	56	56	51	47	36	20	60	
		Cabinet									43	38
162		Cabinet								46	41	
198		Cabinet								48	43	

*Standard room = room with 10m² floor, 2.4m ceiling height, mean absorption 0.2.

CEILING AND WALL-MOUNTED HCC 2_{PLA}

DIMENSIONS

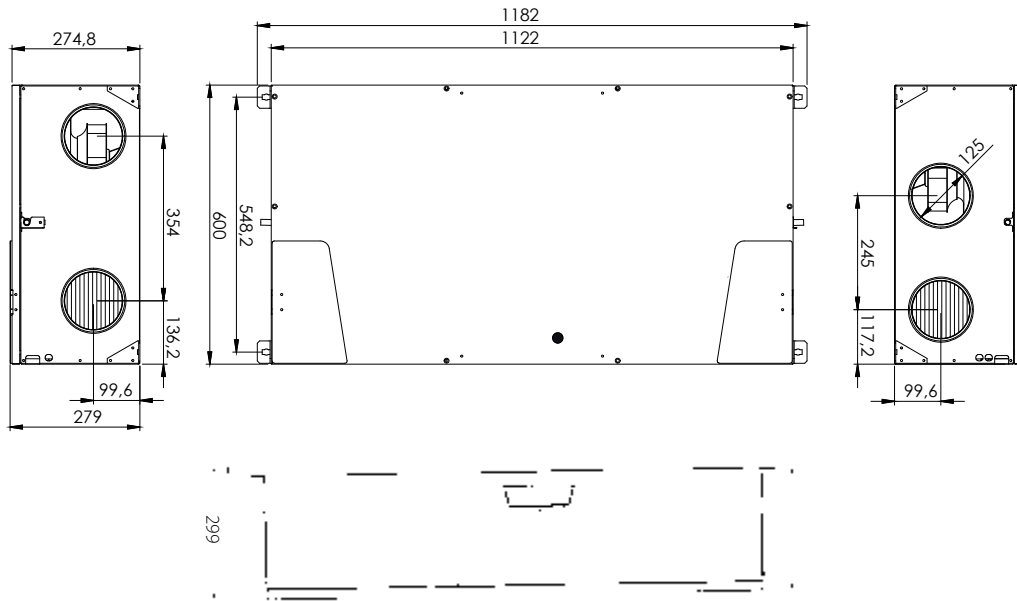

DUCT CONNECTIONS

2 set-up in 1 unit, easy change on site

(A) LEFT SET-UP
Factory set-up

(B) RIGHT SET-UP Optional -
easy change on site

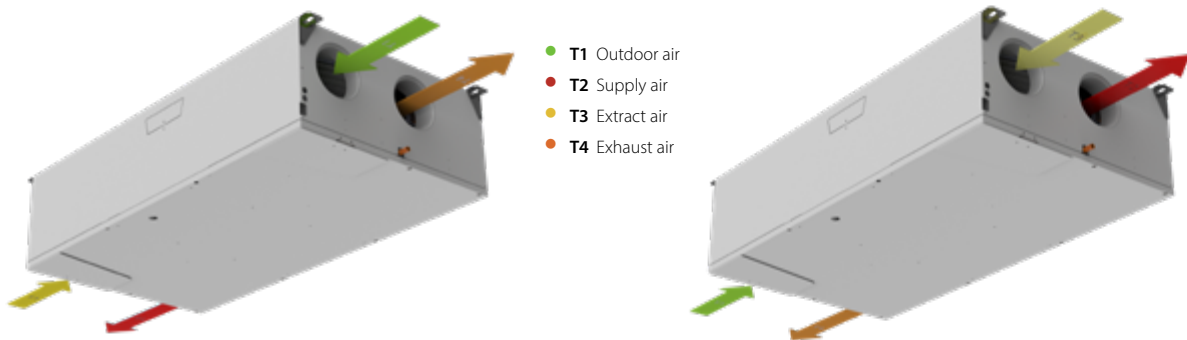

On the HCC 2 it is possible to connect the supply duct to the bottom if the ducts are to run beneath the floor

CEILING AND WALL-MOUNTED HCC 260_{P1}



The HCC 260_{P1} is a unique and flexible residential ventilation solution. With only 30cm installation headroom it is ideal for installation in suspended ceilings or onto a wall, even hidden inside a closet. The unit can be electronically reversed, meaning that both air flows will be reversed. This allows the same unit type to be mounted with the inside/outside ducts connected to either the right or the left hand side of the unit. Electrical connections can be connected from either the left or the right.

The HCC 260_{P1} has an Aluzinc surface, standard filter resetting capability as well as easy PCB access to connect accessories. Delivered 4 units on a pallet at a time, it also minimises the use of packaging in consideration of the environment.



- High efficiency heat recovery – up to 94%
- EC fan motors with low energy consumption (low SPI)
- Only 300mm installation headroom height is required
- Time controlled ventilation level, based on 11 different built-in pre-programmed week programs, reducing power consumption in periods with low ventilation demands
- Summer cooling mode
- Automatic free-cooling features via inbuilt 100% bypass, including the possibility of increasing the air flow automatically, lets in cool night air following hot days to help maintain a comfortable temperature throughout the day
- Fireplace mode, creating a momentary inside overpressure, to enhance chimney functionality
- Easy-to-install and commissioning solution with built-in air measure ports, for easy balancing with PC Tool
- Electronically left/right fan direction switching, allowing same unit type to adapt any physical installation requirements, regardless of ceiling and wall selection
- TCP/IP ModBus connection, for inter-operation with Building Management System
- Electrical connections can be connected from either the left or the right
- Foil panel on unit

Third party testing and certifications

Code	Description
PHI	Passivhaus certified
ErP	Compliant with EU regulations for Eco-design
Nordic Swan Ecolabel	Listed in the Nordic Swan database for products suitable for Ecolabelled buildings

CEILING AND WALL-MOUNTED HCC 260_{P1}

TECHNICAL DATA

Specifications	Units		HCC 260 _{P1}
Max. flow	V100Pa	m ³ /h	260
Max. rated flow	V _{max.rated}	m ³ /h	180
Recommended operating range	V	m ³ /h	50 - 180
Operating range DIBt	V _{DIBt}	m ³ /h	70 to 140
Operating range Passivhaus at 100Pa	V _{PHI}	m ³ /h	50 to 180
EN 13141-7 reference flow at 50Pa	V _{ref}	m ³ /h	126
Performance			
Thermal efficiency DIBt	η _{DIBt}	%	93.8
Thermal efficiency Passivhaus	η _{PHI}	%	93
Thermal efficiency EN 13141-7 at reference flow	η _{EN}	%	94
Leakage (external and internal) according to EN 13141-7	class		<2% (Class A1)
Filters in accordance with ISO16890	-	-	ISO Coarse 75% (optional on supply: ePM1>50%)
Filters in accordance with EN779	-	-	G4 (optional on supply: F7)
Installation surrounding temperature range	t _{surr}	°C	+12 to +40
Maximum humidity in extract air at 25°C	RH	%	55
Outdoor temperature range without preheating installed	t _{ODA}	°C	-12* to +45
Outdoor temperature range with preheating installed	t _{ODA}	°C	-15 to +45
Cabinet			
Dimensions (without wall bracket)	w x d x h	mm	600 x 279 x 1122
Spigots/duct connections	∅	mm	125 – female
Weight	-	kg	34
Heat conductivity – polystyrene insulation	λ	W/mK	0.031
Heat transfer coefficient – polystyrene insulation	U	W/m ² K	<1
Drainage hose (accessory)	∅		1/2"
Cabinet colour	-	-	Alu-zinc
Fire classification of the polystyrene insulation	class	-	DIN 4102-1 class B2 EN 13501 class E
Electrical			
Voltage	U	V	230
Maximum power consumption (without/with preheater)	P	W	127/1,027
Frequency	f	Hz	50
Protection class	-	-	IP20

* In order to ensure balanced ventilation, preheater is recommended when outdoor temperature is below -3°C.

CEILING AND WALL-MOUNTED HCC 260_{P1}

CAPACITY AND SPI CURVES WITH G4/G4 FILTERS

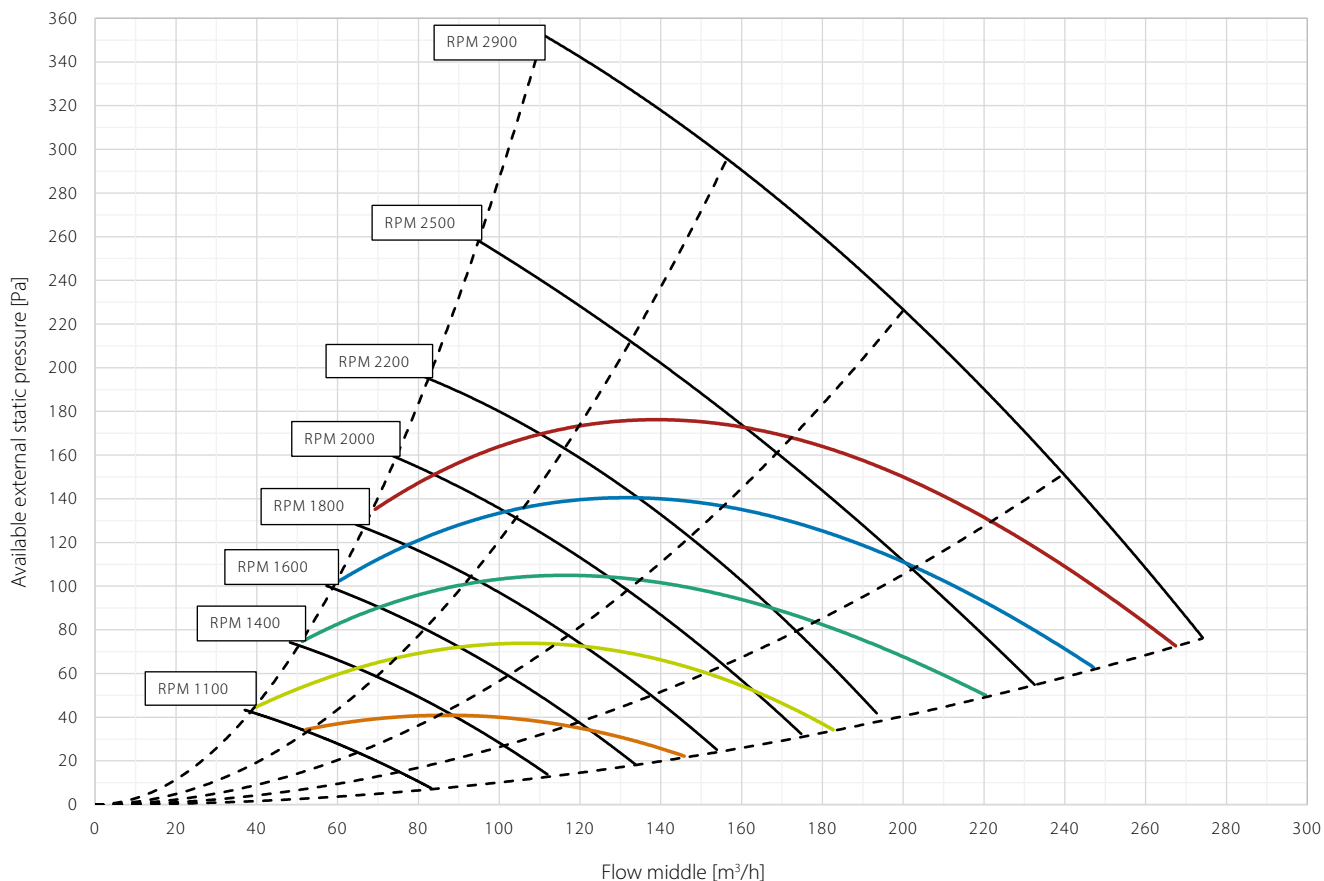

	—	—	—	—	—
SFP/SPI/SEL*	0.45 W/m ³ /h	0.39 W/m ³ /h	0.33 W/m ³ /h	0.28 W/m ³ /h	0.22 W/m ³ /h
	1620 J/m ³	1400 J/m ³	1200 J/m ³	1000 J/m ³	800 J/m ³
	1.62 W/l/s	1.40 W/l/s	1.20 W/l/s	1.0 W/l/s	0.80 W/l/s

* SFP/SPI/SEL includes power consumption of both fans and the control.

THERMAL EFFICIENCY CURVES

Legend

- Thermal efficiency according to EN 13141-7 (dry)
Operational conditions: outdoor air: 7°C, 88% RH; extract air: 20°C, 38% RH
- Thermal efficiency according to EN 13141-7 (with condensation)
Operational conditions: outdoor air: 2°C, 85% RH; extract air: 20°C, 60% RH
- Thermal efficiency according Passivhaus Institut
Operational conditions: outdoor air: 4°C, 94% RH; extract air: 21°C, 30% RH

All values at balanced flow

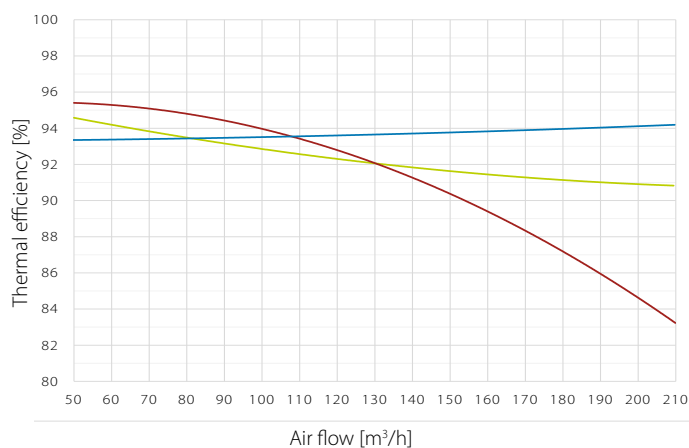

CEILING AND WALL-MOUNTED

HCC 260_{P1}

SOUND DATA WITH G4/G4 FILTERS

Air-volume m ³ /h	Pres. Pa	Measure point	Frequency band sound power L _w (A) dB(A)								Total sound power L _w (A) dB(A)	Sound pres. L _p (A) Standard room*
			63Hz	125Hz	250Hz	500Hz	1000Hz	2000Hz	4000Hz	8000Hz		
80	30	Supply air	23	43	40	42	39	32	20	18	47	
		Extract air	12	26	24	24	16	16	17	18	30	
		Cabinet									30	25
98	50	Supply air	28	41	51	48	44	39	26	18	54	
		Extract air	16	27	31	29	19	16	17	18	35	
		Cabinet									34	29
100	100	Supply air	32	49	56	52	49	44	33	19	59	
		Extract air	19	31	42	33	23	19	17	18	43	
		Cabinet									37	32
126	70	Supply air	31	43	55	52	49	45	33	19	58	
		Extract air	19	30	42	33	23	19	17	18	42	
		Exhaust air	30	43	54	52	47	43	32	18	57	
		Cabinet									40	35
140	100	Supply air	34	46	56	56	52	49	37	21	60	
		Extract air	21	33	44	36	27	21	18	18	45	
		Exhaust air	33	45	56	56	51	47	36	20	60	
		Cabinet									43	38
162		Cabinet								46	41	
198		Cabinet								48	43	

* Standard room = room with 10m² floor, 2.4m ceiling height, mean absorption 0.2.

CEILING AND WALL-MOUNTED HCC 260_{P1}

DIMENSIONS

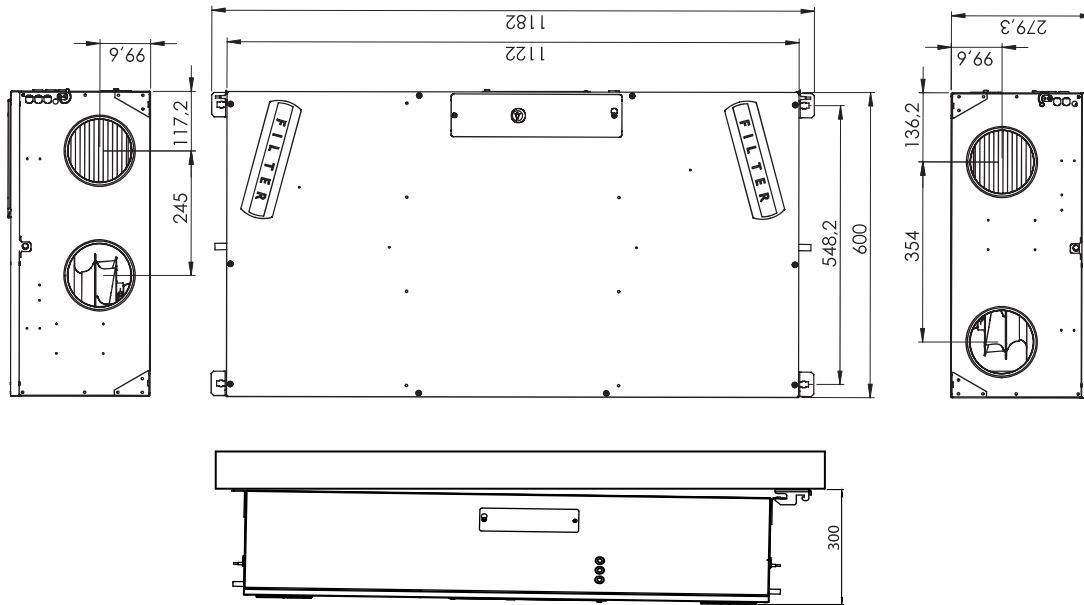

REVIT

Revit files are available for free on request. Contact your local supplier or Dantherm for access.

DUCT CONNECTIONS

2 set-up in 1 unit, easy change on site

(A) LEFT SET-UP
Factory set-up

(B) RIGHT SET-UP Optional -
easy change on site

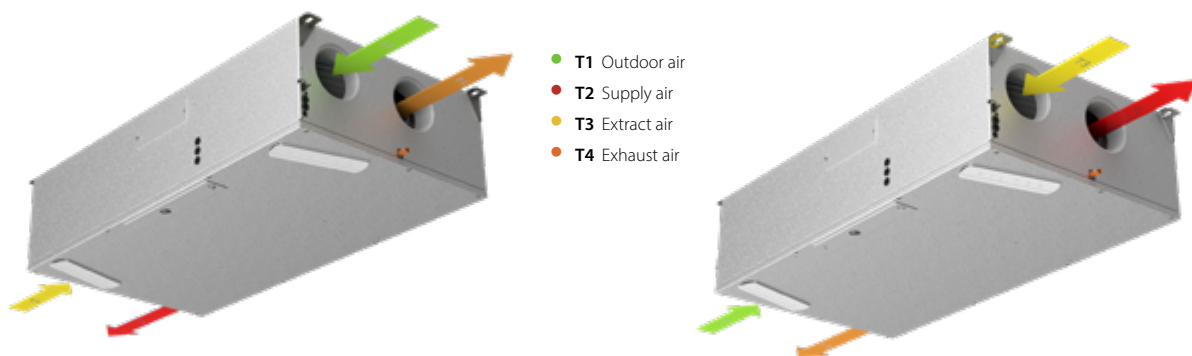

CEILING AND WALL-MOUNTED HCC 360_{E1}



The HCC 360_{E1} is a unique and flexible residential ventilation solution. With only 30cm installation headroom it is ideal for installation in suspended ceilings or onto a wall, even hidden inside a closet. The unit can be electronically reversed, meaning that both air flows will be reversed. This allows the same unit type to be mounted with the inside/outside ducts connected to either the right or the left hand side of the unit. Electrical connections can be connected from either the left or the right.

The HCC 360_{E1}'s surface is in Aluzinc and the units will be delivered on pallets of four to reduce packaging and shipping costs. This makes it ideal for large-scale projects.



- High efficiency heat recovery – up to 85%
- EC fan motors with low energy consumption (low SPI)
- Only 300mm installation headroom height is required
- Time controlled ventilation level, based on 11 different built-in pre-programmed week programs, reducing power consumption in periods with low ventilation demands
- Summer cooling mode
- Automatic free-cooling features via inbuilt 100% bypass, including the possibility of increasing the air flow automatically, lets in cool night air following hot days to help maintain a comfortable temperature throughout the day
- Fireplace mode, creating a momentary inside overpressure, to enhance chimney functionality
- Easy-to-install and commissioning solution with built in air measure ports, for easy balancing with PC Tool
- Electronically left/right fan direction switching, allowing same unit type to adapt any physical installation requirements, regardless of ceiling and wall selection
- TCP/IP ModBus connection, for inter-operation with Building Management System
- Electrical connections can be connected from either the left or the right
- Two humidity sensors to facilitate switching from left/right setup
- Prepared for easy mounting of condensate pump

Third party testing and certifications

Code	Description
ErP	Compliant with EU regulations for Eco-design
Nordic Swan Ecolabel	Listed in the Nordic Swan database for products suitable for Ecolabelled buildings

CEILING AND WALL-MOUNTED HCC 360_{E1}

TECHNICAL DATA

Specifications	Units		HCC 360 _{E1}
Max. flow	V100Pa	m ³ /h	360
Max. rated flow	V _{max.rated}	m ³ /h	180
Recommended operating range	V	m ³ /h	50 - 180
EN 13141-7 reference flow at 50Pa	V _{ref}	m ³ /h	126
Performance			
Thermal efficiency EN 13141-7 at reference flow	η_{EN}	%	80
Leakage (external and internal) according to EN 13141-7	class		<2% (Class A1)
Filters in accordance with ISO16890	-	-	ISO Coarse 75% (optional on supply: ePM1>50%)
Filters in accordance with EN779	-	-	G4 (optional on supply: F7)
Installation surrounding temperature range	t _{surr}	°C	+12 to +40
Maximum humidity in extract air at 25°C	RH	%	55
Outdoor temperature range without preheating installed	t _{ODA}	°C	-12* to +45
Outdoor temperature range with preheating installed	t _{ODA}	°C	-15 to +45
Cabinet			
Dimensions (without wall bracket)	w x d x h	mm	600 x 279 x 1122
Spigots/duct connections	Ø	mm	125 – female
Weight	-	kg	34
Heat conductivity – polystyrene insulation	λ	W/mK	0.031
Heat transfer coefficient – polystyrene insulation	U	W/(m ² K)	<1
Drainage hose (accessory)	Ø	"	1/2
Cabinet colour	RAL	-	no paint/raw Alu-zinc
Fire classification of the polystyrene insulation	-	-	DIN 4102-1 class B2 EN 13501 class E
Electrical			
Voltage	U	V	230
Maximum power consumption (without/with preheater)	P	W	161/1,061
Frequency	f	Hz	50
Protection class	-	-	IP20

* In order to ensure balanced ventilation, preheater is recommended when outdoor temperature is below -5°C.

CEILING AND WALL-MOUNTED HCC 360_{E1}

CAPACITY AND SPI CURVES WITH G4/G4 FILTERS

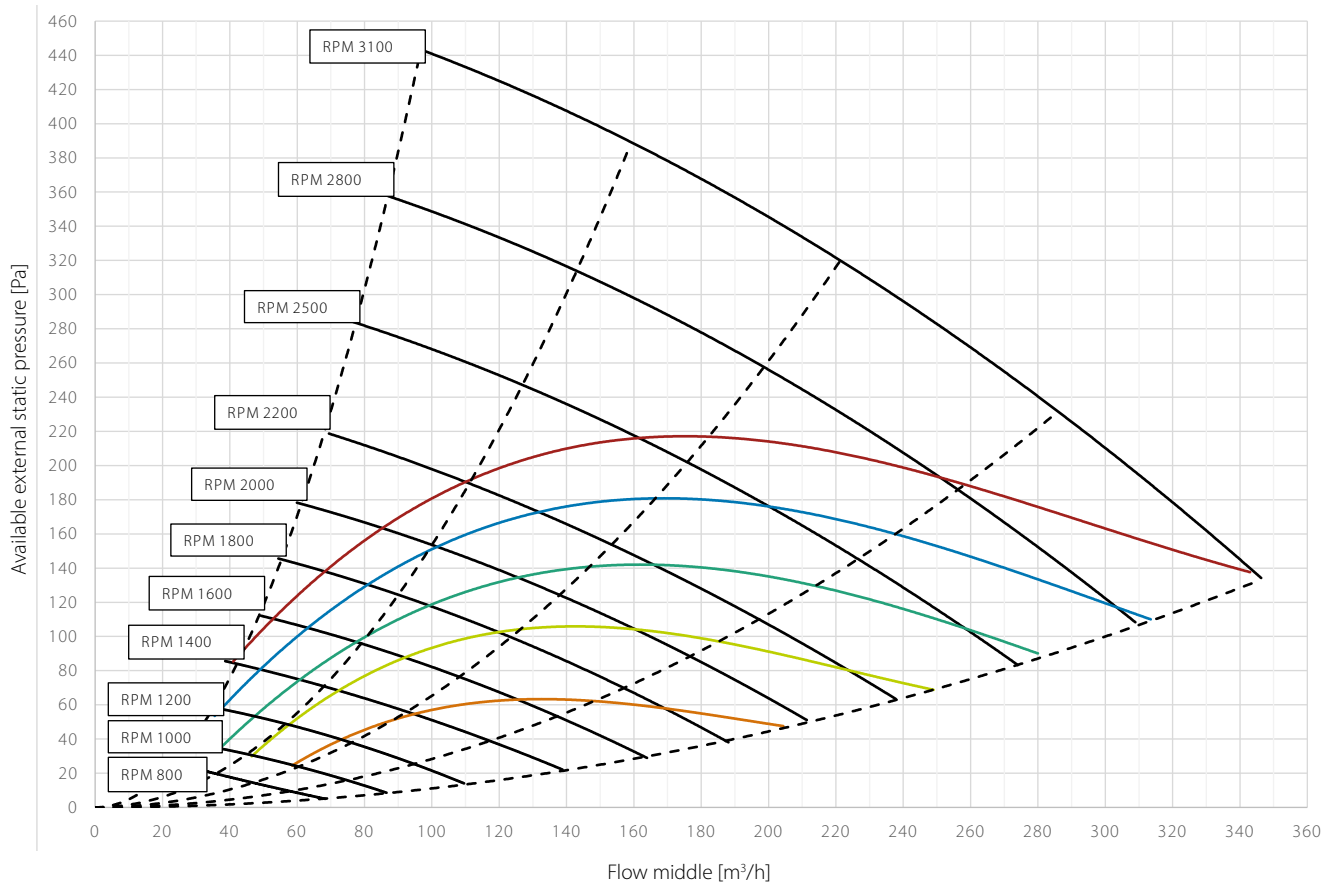

	—	—	—	—	—
SFP/SPI/SEL*	0.45 W/m ³ /h	0.39 W/m ³ /h	0.33 W/m ³ /h	0.28 W/m ³ /h	0.22 W/m ³ /h
	1620 J/m ³	1400 J/m ³	1200 J/m ³	1000 J/m ³	800 J/m ³
	1.62 W/l/s	1.40 W/l/s	1.20 W/l/s	1.0 W/l/s	0.80 W/l/s

* SFP/SPI/SEL includes power consumption of both fans and the control.

THERMAL EFFICIENCY CURVES

Legend

- Thermal efficiency according to EN 13141-7 (dry)
Operational conditions: outdoor air: 7°C, 70% RH; extract air: 20°C, 38% RH
- Humidity efficiency according to EN 13141-7 (with condensation)
Operational conditions: outdoor air: 2°C, 88% RH; extract air: 20°C, 60% RH

All values at balanced flow

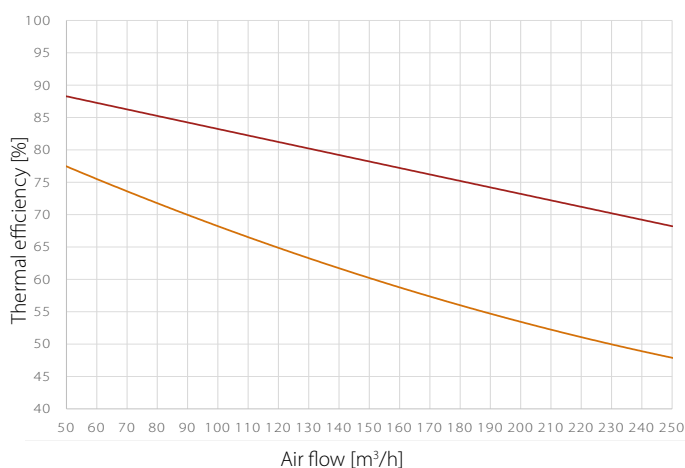

CEILING AND WALL-MOUNTED

HCC 360_{E1}

SOUND POWER LEVEL (L_w) – DUCTS

RPM	Duct	[dB(A)]								
		63Hz	125Hz	250Hz	500Hz	1kHz	2kHz	4kHz	8kHz	Total
1400	supply/exhaust	29.7	44.1	48.1	48.4	46.6	43.8	33.3	18.4	54
	extract/outdoor	25.1	33.2	38.3	36.9	21.9	15.9	-	-	42
1600	supply/exhaust	31.7	44.1	58.0	52.1	50.0	47.3	37.5	23.4	60
	extract/outdoor	27.5	33.3	46.6	45.2	25.7	19.2	-	-	49
1800	supply/exhaust	33.8	44.2	60.3	54.6	52.9	50.2	40.8	27.8	62
	extract/outdoor	30.0	33.5	46.6	46.1	29.1	22.3	-	-	50
2000	supply/exhaust	36.0	44.4	64.4	56.5	55.4	52.8	43.9	31.5	66
	extract/outdoor	32.8	35.0	50.9	46.3	32.0	25.4	13.1	-	52
2200	supply/exhaust	37.3	45.8	64.4	59.9	57.7	55.2	46.7	35.0	67
	extract/outdoor	34.1	37.1	51.0	48.4	34.7	28.2	16.2	-	53
2500	supply/exhaust	39.9	48.0	64.5	62.5	61.1	58.8	50.2	39.8	68
	extract/outdoor	36.7	39.6	52.0	49.3	38.2	32.1	20.8	-	54
2800	supply/exhaust	42.4	50.2	67.9	65.6	64.1	61.8	53.2	43.3	72
	extract/outdoor	39.3	42.2	54.5	55.1	41.7	35.5	24.8	13.3	58
3100	supply/exhaust	54.5	52.5	68.7	70.5	67.6	64.7	56.0	46.3	74
	extract/outdoor	47.9	44.4	55.3	64.8	45.6	38.6	28.4	17.6	65

SOUND PRESSURE LEVEL (L_p) – CABINET

1m distance

RPM	[dB(A)]								Total
	63Hz	125Hz	250Hz	500Hz	1kHz	2kHz	4kHz	8kHz	
1000	-	-	9.9	17.8	18.1	20.1	15.7	-	24
1200	-	-	11.0	19.5	19.1	20.2	15.7	-	25
1400	-	-	13.1	22.6	19.1	20.2	15.7	-	26
1500	-	-	18.0	25.0	21.0	20.4	15.8	-	28
1600	-	-	24.0	26.7	21.0	20.6	15.9	-	30
1700	-	-	26.2	29.2	21.4	21.0	16.0	-	32
1800	-	-	26.3	30.2	21.4	21.5	16.1	-	33
1900	-	-	27.0	31.7	22.9	21.8	16.3	-	34
2000	-	-	28.0	32.0	25.3	22.0	16.4	-	34
2100	-	-	29.5	32.9	25.4	22.7	16.9	-	35
2200	-	-	30.0	33.0	25.6	23.0	18.4	-	36
2300	-	-	30.4	34.8	26.3	23.4	19.0	-	37
2500	-	-	32.0	36.3	28.4	25.5	19.5	10.0	38
2700	-	-	36.1	40.8	30.5	27.5	19.7	11.1	43
2800	-	-	36.5	41.7	32.6	28.5	21.4	12.9	43
2900	-	-	31.7	45.3	32.7	29.0	22.2	13.3	46
3100	-	11.2	40.0	47.2	34.4	31.1	24.9	15.6	48

2m distance

RPM	[dB(A)]								Total
	63Hz	125Hz	250Hz	500Hz	1kHz	2kHz	4kHz	8kHz	
1000	-	-	5.6	17.8	18.1	18.2	14.1	-	23
1200	-	-	6.9	19.5	19.1	18.2	14.8	-	24
1400	-	-	10.6	21.1	19.1	19.3	15.0	-	25
1500	-	-	15.8	24.1	19.2	19.3	15.2	-	27
1600	-	-	17.7	25.0	20.7	20.0	15.6	-	28
1700	-	-	19.8	26.0	21.0	20.1	16.0	-	29
1800	-	-	20.0	28.3	21.0	20.2	16.1	-	30
1900	-	-	21.0	31.2	22.8	20.2	16.2	-	32
2000	-	-	22.0	31.5	22.8	20.5	16.4	-	33
2100	-	-	23.5	32.9	23.6	20.5	16.7	-	34
2200	-	-	23.5	33.0	25.0	22.4	18.4	-	34
2300	-	-	24.0	33.6	25.0	22.4	19.0	-	35
2500	-	-	29.0	34.7	26.1	24.3	19.5	-	37
2700	-	-	30.9	38.7	27.7	26.0	19.7	-	40
2800	-	-	31.0	39.0	28.4	26.1	20.9	-	40
2900	-	-	31.0	43.0	29.3	26.4	21.0	-	44
3100	-	6.7	31.0	45.3	31.4	28.1	21.9	10.6	46

CEILING AND WALL-MOUNTED HCC 360_{E1}

DIMENSIONS

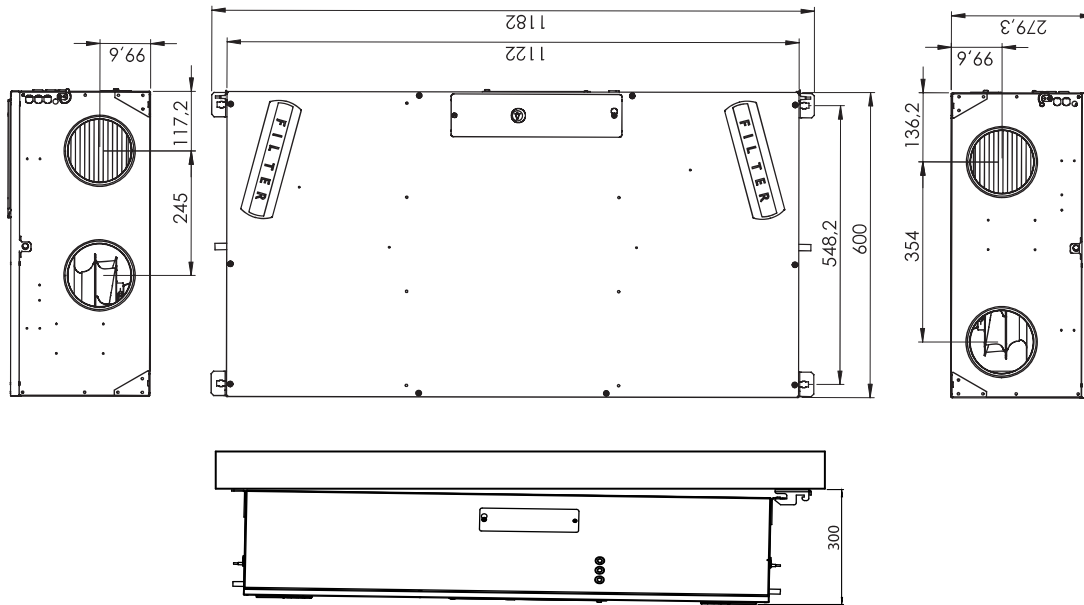

REVIT Revit files are available for free on request. Contact your local supplier or Dantherm for access.

DUCT CONNECTIONS

2 set-up in 1 unit, easy change on site

(A) LEFT SET-UP
Factory set-up

(B) RIGHT SET-UP Optional -
easy change on site

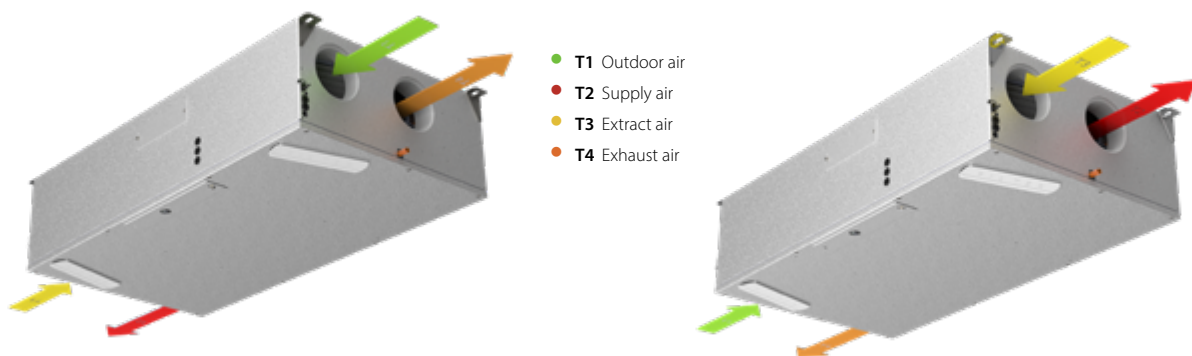

CEILING AND WALL-MOUNTED HCC 360_{P2}



The HCC 360_{P2} is a unique and flexible residential ventilation solution. With only 30cm installation headroom it is ideal for installation in suspended ceilings or onto a wall, even hidden inside a closet. The unit can be electronically reversed, meaning that both air flows will be reversed. This allows the same unit type to be mounted with the inside/outside ducts connected to either the right or the left hand side of the unit. Electrical connections can be connected from either the left or the right.

The HCC 360_{P2}'s surface is in Aluzinc and the units will be delivered on pallets of four to reduce packaging and shipping costs. This makes it ideal for large-scale projects.



- High efficiency heat recovery – up to 85%
- EC fan motors with low energy consumption (low SPI)
- Only 300mm installation headroom height is required
- Time controlled ventilation level, based on 11 different built-in pre-programmed week programs, reducing power consumption in periods with low ventilation demands
- Summer cooling mode
- Automatic free-cooling features via inbuilt 100% bypass, including the possibility of increasing the air flow automatically, lets in cool night air following hot days to help maintain a comfortable temperature throughout the day
- Fireplace mode, creating a momentary inside overpressure, to enhance chimney functionality
- Easy-to-install and commissioning solution with built in air measure ports, for easy balancing with PC Tool
- Electronically left/right fan direction switching, allowing same unit type to adapt any physical installation requirements, regardless of ceiling and wall selection
- TCP/IP ModBus connection, for inter-operation with Building Management System
- Electrical connections can be connected from either the left or the right
- Two humidity sensors to facilitate switching from left/right setup
- Prepared for easy mounting of condensate pump

Third party testing and certifications

Code	Description
ErP	Compliant with EU regulations for Eco-design
Nordic Swan Ecolabel	Listed in the Nordic Swan database for products suitable for Ecolabelled buildings

CEILING AND WALL-MOUNTED HCC 360_{P2}

TECHNICAL DATA

Specifications	Units		HCC 360 _{P2}
Max. flow	V100Pa	m ³ /h	360
Max. rated flow	V _{max.rated}	m ³ /h	220
Recommended operating range	V	m ³ /h	50 - 220
EN 13141-7 reference flow at 50Pa	V _{ref}	m ³ /h	154
Performance			
Thermal efficiency EN 13141-7 at reference flow	η_{EN}	%	88
Leakage (external and internal) according to EN 13141-7	class		<2% (Class A1)
Filters in accordance with ISO16890	-	-	ISO Coarse 75% (optional on supply: ePM1>50%)
Filters in accordance with EN779	-	-	G4 (optional on supply: F7)
Installation surrounding temperature range	t _{surr}	°C	+12 to +40
Maximum humidity in extract air at 25°C	RH	%	55
Outdoor temperature range without preheating installed	t _{ODA}	°C	-12* to +45
Outdoor temperature range with preheating installed	t _{ODA}	°C	-15 to +45
Cabinet			
Dimensions (without wall bracket)	w x d x h	mm	600 x 279 x 1122
Spigots/duct connections	Ø	mm	125 – female
Weight	-	kg	34
Heat conductivity – polystyrene insulation	λ	W/mK	0.031
Heat transfer coefficient – polystyrene insulation	U	W/m ² K	U<1
Drainage hose (accessory)	Ø	"	1/2
Cabinet colour	RAL	-	no paint/raw Alu-zinc
Fire classification of the polystyrene insulation	-	-	DIN 4102-1 class B2 EN 13501 class E
Electrical			
Voltage	U	V	230
Maximum power consumption (without/with preheater)	P	W	161/1,061
Frequency	f	Hz	50
Protection class	-	-	IP20

* In order to ensure balanced ventilation, preheater is recommended when outdoor temperature is below -3°C.

CEILING AND WALL-MOUNTED HCC 360_{P2}

CAPACITY AND SPI CURVES WITH G4/G4 FILTERS

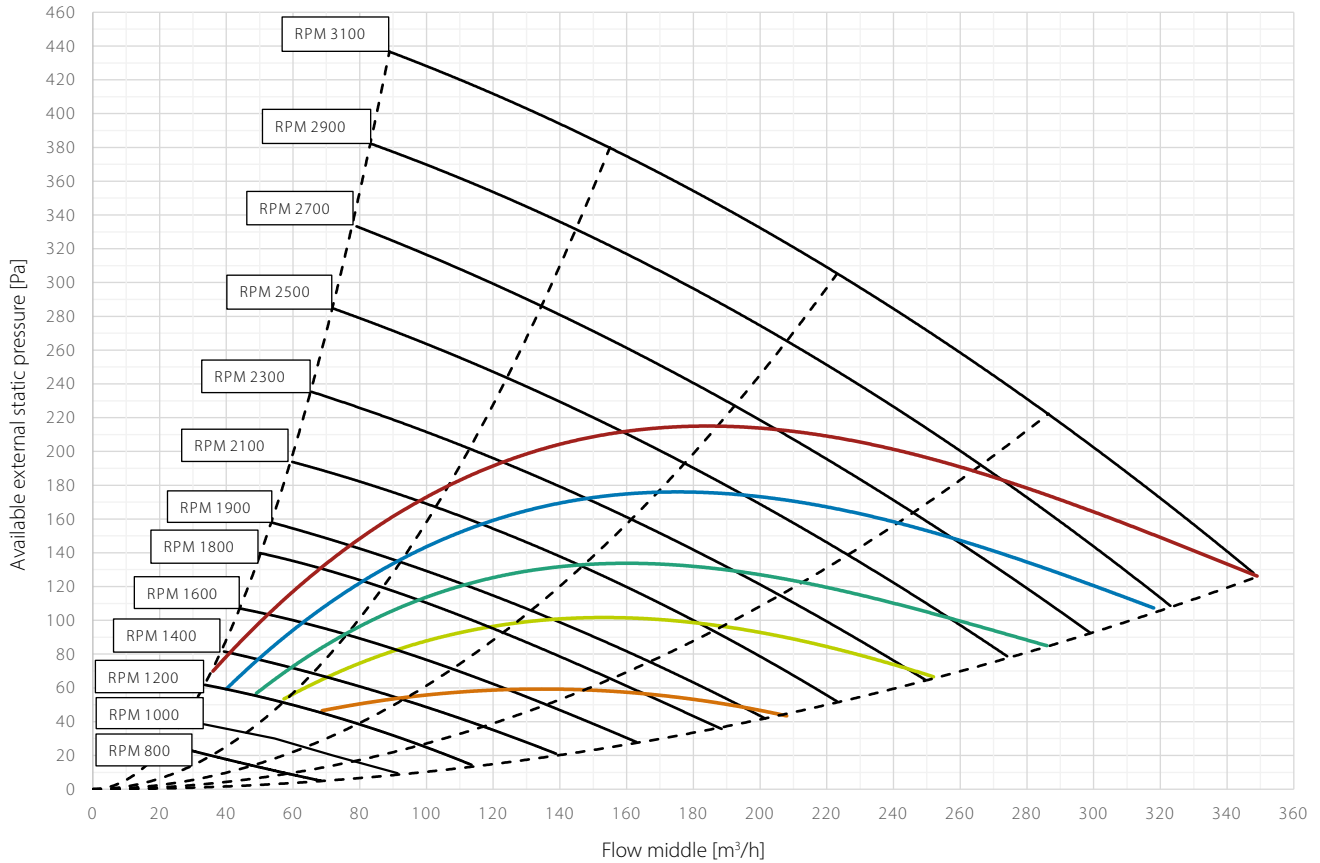

	—	—	—	—	—
SFP/SPI/SEL*	0.45 W/m ³ /h	0.39 W/m ³ /h	0.33 W/m ³ /h	0.28 W/m ³ /h	0.22 W/m ³ /h
	1620 J/m ³	1400 J/m ³	1200 J/m ³	1000 J/m ³	800 J/m ³
	1.62 W/l/s	1.40 W/l/s	1.20 W/l/s	1.0 W/l/s	0.80 W/l/s

* SFP/SPI/SEL includes power consumption of both fans and the control.

THERMAL EFFICIENCY CURVES

Legend

- Thermal efficiency according to EN 13141-7 (dry)
Operational conditions: outdoor air: 7°C, 88% RH; extract air: 20°C, 38% RH
All values at balanced flow

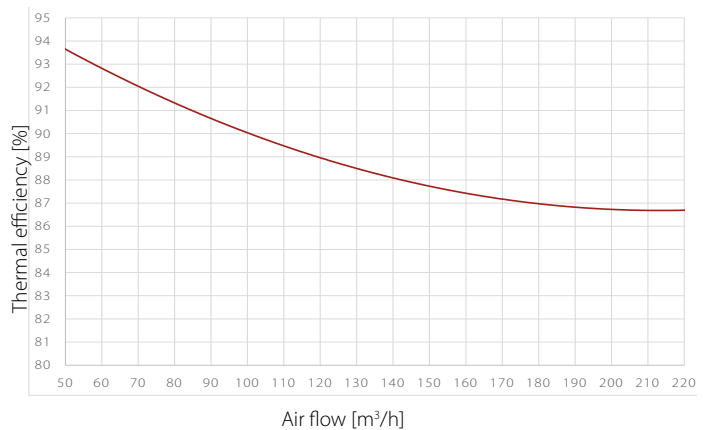

CEILING AND WALL-MOUNTED

HCC 360_{P2}

SOUND POWER LEVEL (L_w) – DUCTS

RPM	Duct	[dB(A)]								Total
		63Hz	125Hz	250Hz	500Hz	1kHz	2kHz	4kHz	8kHz	
1000	supply/exhaust	21.3	34.5	38.1	37.2	34.3	30.7	17.6	-	43
	extract/outdoor	20.2	28.7	25.8	27.9	14.1	-	-	-	33
1200	supply/exhaust	24.4	44.1	40.7	41.5	39.1	36.2	24.5	-	48
	extract/outdoor	20.8	35.2	29.1	31.6	16.9	12.5	-	-	38
1400	supply/exhaust	27.7	44.1	44.5	45.7	43.2	40.4	30.1	15.5	51
	extract/outdoor	24.7	37.0	34.6	35.3	21.4	16.3	-	-	41
1500	supply/exhaust	34.5	45.1	47.8	48.1	44.8	42.9	33.4	18.5	53
	extract/outdoor	25.5	37.2	36.1	37.7	23.0	17.7	-	-	42
1700	supply/exhaust	38.4	45.2	52.3	51.5	48.3	46.8	37.3	23.5	57
	extract/outdoor	28.0	37.4	41.5	42.6	26.5	21.2	-	-	46
1900	supply/exhaust	38.5	45.3	58.4	54.7	52.1	49.5	40.9	28.1	61
	extract/outdoor	31.2	37.6	46.3	45.5	30.8	24.9	10.8	-	49
2100	supply/exhaust	38.6	45.4	61.0	56.7	53.7	51.8	43.5	32.0	63
	extract/outdoor	33.2	37.8	48.6	45.5	34.0	27.7	14.8	-	51
2300	supply/exhaust	38.7	45.5	61.0	61.3	57.8	55.1	46.7	36.1	66
	extract/outdoor	34.9	38.0	49.0	46.9	36.5	30.6	17.6	-	52
2500	supply/exhaust	38.9	46.6	61.8	62.1	59.6	57.4	49.0	38.8	67
	extract/outdoor	36.2	38.2	52.3	48.4	38.9	33.3	20.7	-	54
2700	supply/exhaust	40.5	48.6	66.0	64.1	61.7	59.6	51.1	41.4	70
	extract/outdoor	38.9	39.8	61.7	52.3	41.3	35.9	23.6	12.4	62
2900	supply/exhaust	42.3	50.5	68.8	67.1	64.4	61.7	53.2	43.7	72
	extract/outdoor	40.1	41.5	64.4	59.7	44.1	38.1	26.2	15.0	66
3100	supply/exhaust	54.9	51.4	69.0	71.4	68.5	63.7	55.2	45.7	75
	extract/outdoor	49.1	42.7	56.4	67.3	47.9	40.1	28.6	17.5	68

SOUND PRESSURE LEVEL (L_P) – CABINET

1m distance

RPM	[dB(A)]								Total
	63Hz	125Hz	250Hz	500Hz	1kHz	2kHz	4kHz	8kHz	
1000	-	-	9.9	17.8	18.1	20.1	15.7	-	24
1200	-	-	11.0	19.5	19.1	20.2	15.7	-	25
1400	-	-	13.1	22.6	19.1	20.2	15.7	-	26
1500	-	-	18.0	25.0	21.0	20.4	15.8	-	28
1600	-	-	24.0	26.7	21.0	20.6	15.9	-	30
1700	-	-	26.2	29.2	21.4	21.0	16.0	-	32
1800	-	-	26.3	30.2	21.4	21.5	16.1	-	33
1900	-	-	27.0	31.7	22.9	21.8	16.3	-	34
2000	-	-	28.0	32.0	25.3	22.0	16.4	-	34
2100	-	-	29.5	32.9	25.4	22.7	16.9	-	35
2200	-	-	30.0	33.0	25.6	23.0	18.4	-	36
2300	-	-	30.4	34.8	26.3	23.4	19.0	-	37
2500	-	-	32.0	36.3	28.4	25.5	19.5	10.0	38
2700	-	-	36.1	40.8	30.5	27.5	19.7	11.1	43
2800	-	-	36.5	41.7	32.6	28.5	21.4	12.9	43
2900	-	-	31.7	45.3	32.7	29.0	22.2	13.3	46
3100	-	11.2	40.0	47.2	34.4	31.1	24.9	15.6	48

2m distance

RPM	[dB(A)]								Total
	63Hz	125Hz	250Hz	500Hz	1kHz	2kHz	4kHz	8kHz	
1000	-	-	5.6	17.8	18.1	18.2	14.1	-	23
1200	-	-	6.9	19.5	19.1	18.2	14.8	-	24
1400	-	-	10.6	21.1	19.1	19.3	15.0	-	25
1500	-	-	15.8	24.1	19.2	19.3	15.2	-	27
1600	-	-	17.7	25.0	20.7	20.0	15.6	-	28
1700	-	-	19.8	26.0	21.0	20.1	16.0	-	29
1800	-	-	20.0	28.3	21.0	20.2	16.1	-	30
1900	-	-	21.0	31.2	22.8	20.2	16.2	-	32
2000	-	-	22.0	31.5	22.8	20.5	16.4	-	33
2100	-	-	23.5	32.9	23.6	20.5	16.7	-	34
2200	-	-	23.5	33.0	25.0	22.4	18.4	-	34
2300	-	-	24.0	33.6	25.0	22.4	19.0	-	35
2500	-	-	29.0	34.7	26.1	24.3	19.5	-	37
2700	-	-	30.9	38.7	27.7	26.0	19.7	-	40
2800	-	-	31.0	39.0	28.4	26.1	20.9	-	40
2900	-	-	31.0	43.0	29.3	26.4	21.0	-	44
3100	-	6.7	31.0	45.3	31.4	28.1	21.9	10.6	46

CEILING AND WALL-MOUNTED HCC 360_{P2}

DIMENSIONS

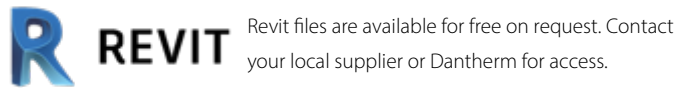
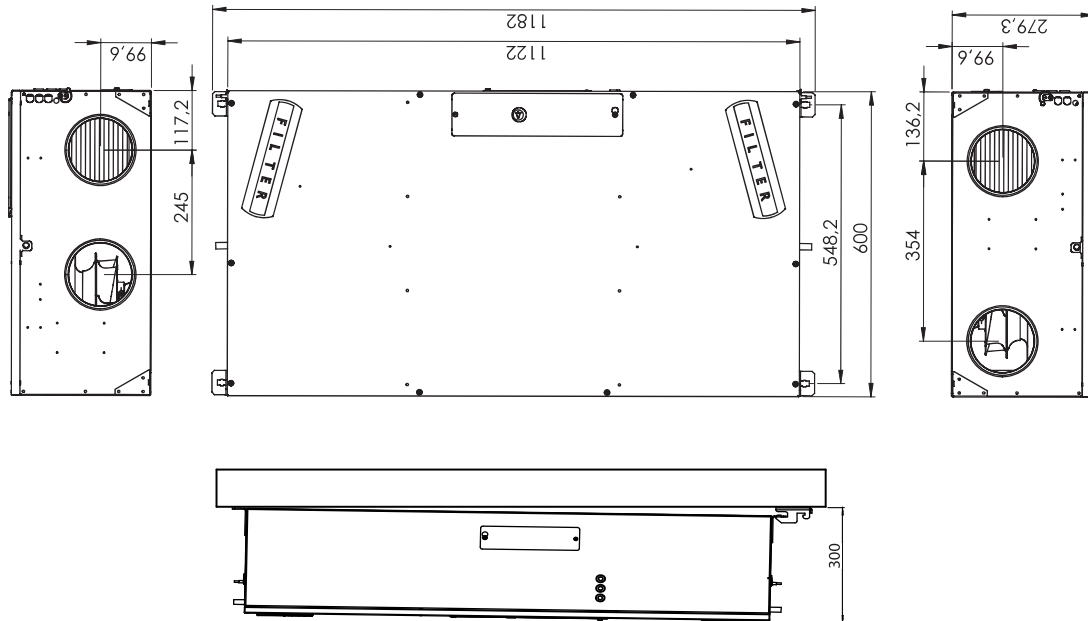

DUCT CONNECTIONS

2 set-up in 1 unit, easy change on site

(A) LEFT SET-UP
Factory set-up

(B) RIGHT SET-UP Optional -
easy change on site

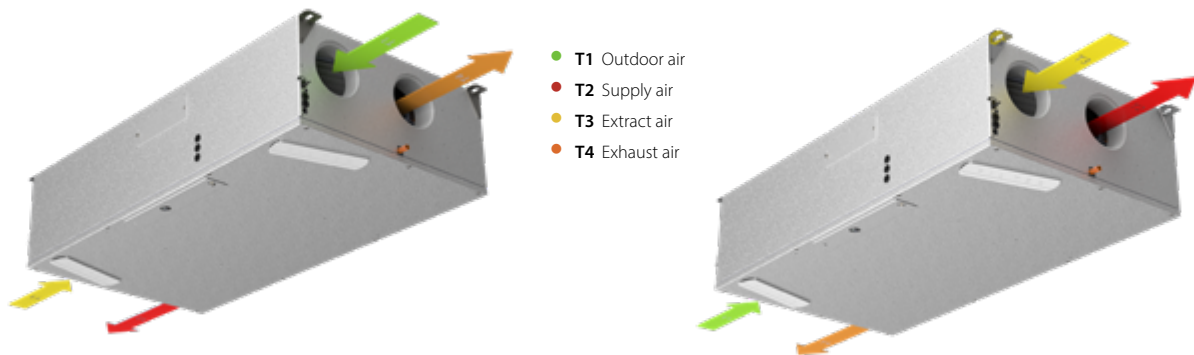

ATTIC- AND WALL-MOUNTED



ENERGY-EFFICIENT VENTILATION SOLUTIONS FOR: HOMES, APARTMENTS, NEW-BUILDS AND RENOVATIONS

QUICK GUIDE



RCV 320



HCH 5



HCH 8

INSTALLATION



WALL-MOUNTED



ATTIC-MOUNTED



CEILING

	RCV 320	HCH 5	HCH 8
WALL-MOUNTED	●		
ATTIC-MOUNTED	●	●	●
CEILING			

ATTIC AND WALL-MOUNTED UNITS

RCV RANGE



Function

All units are equipped with easy-access filter slots behind the upper front cover. The control panel with LED light indicators is located in an opening in the front cover.

Cabinet

The RCV insulation is made of expanded polystyrene (EPS) with outer surface is made of 0.8mm Aluzinc sheet metal. This has a high insulation level, and good air tightness, which permits location of the units in spaces with temperatures down to -12°C.

The RCV series complies with European fire safety requirements as specified in EN 13501 class E

The leakage rate of the unit (internal and external) is <2% as specified in EN13141-7 leakage class A1.

Installation

After installation of the unit, ducts and condensate hose, the unit needs to be calibrated to the specific environment. Appropriate initial adjustments are performed with Dantherm PC Tool.

Function

The unit ventilates residential homes by extracting the inside humid air, and replacing it with fresh outside air, which has been heated with the heat energy of the extracted air. This reduces energy consumption.

The air volume can be controlled by:

- Selecting a fixed fan speed from 0-4
- Demand mode, in which a built in RH sensor continuously adjusts the fan speed depending on any immediate demand, determined by the humidity of the extracted air
- Week timer program – the fan speed will increase or decrease according to an hourly time schedule, or specific demand

When very humid inside air is extracted, the humidity will condensate inside the heat exchanger and be collected by the embedded drip tray. This water is drained from the unit through the enclosed hose and then disposed of in the nearest drainage. ducts connected to the home (supply and extract) are always on the left-hand side of the unit. The condensation drain is located at the rear of the unit.

Maintenance

In general, the only regular maintenance required by the RCV residential ventilation units is to check/change the air filters twice a year when the alarm is triggered (flashing LED and acoustic alarm).

The user changes the filter by opening the filter cover, changing the filters and resetting the filter timer on the built-in control panel.

Apart from changing the air filters and cleaning the outside of the unit, any other form of service will have to be carried out by qualified personnel.

Local Dantherm partners are always available with support to solve any problem that might arise with the unit.

Removing the front cover gives access to all types of service and repair.

ATTIC AND WALL-MOUNTED UNITS

RCV RANGE

Flexible unit

The factory-mounted duct seals on the side of the unit can easily be removed using a side cutter and then used to seal off other ducts not to be used.

Mirroring all duct connections

2 set-up in 1 unit, easy change on site

The air flow direction can be electronically swapped, providing ability to route the connected ducts, either to the right or to the left. This means that the supply air duct connections can be either to the right or to the left hand side of the unit.

Unlike all other residential ventilation units on the market, the RCV offers a stunning 48 different ways of connecting ducts to the unit.

24 available combinations for left setups (A) and 24 for right setups (B). Simply choose whichever one is more convenient in terms of installation!

With this flexible unit, you'll be able to find a fast and cost-efficient way to finalise installation work, even in the trickiest of installation areas.

On the RCV 320 it is possible to connect the supply duct to the bottom if the ducts are to run beneath the floor

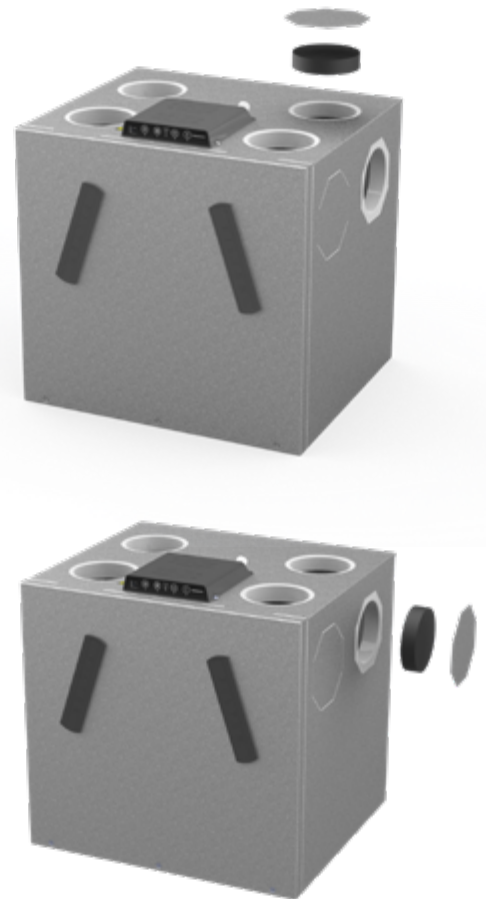

DUCT CONNECTIONS

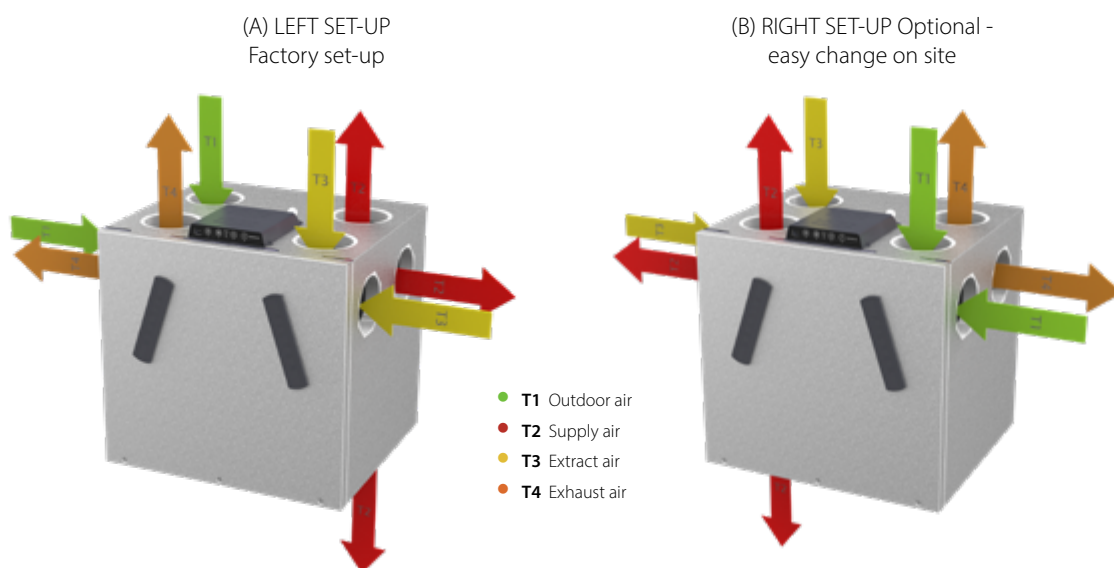

On the RCV 320 it is possible to connect the supply duct to the bottom if the ducts are to run beneath the floor

WALL AND ATTIC-MOUNTED UNITS

RCV 320_{p1}



The 320_{p1} is a highly efficient and very compact residential ventilation unit for houses, villas, and apartments. Based on patent-pending technology and an ingenious design, it is delivered as a true plug and play solution with a built-in control panel and all necessary parts for on-site wall installation.

Heat recovery takes place in a highly efficient counter-flow heat exchanger, which is able to achieve optimum efficiency with the least possible loss of pressure in connection with the low air volumes used in housing.

All units come with an Aluzinc surface finish and will be packaged four units on a pallet at a time to ease handling at building sites.

- Demand-controlled ventilation with integrated humidity sensor, reducing power consumption at times with low ventilation demands
- Summer mode in which the supply fan is stopped, thereby reducing power consumption. Open windows will supply cooler outside air, lowering the room temperature
- Automatic free-cooling features via inbuilt 100% bypass, including the possibility of increasing the air flow automatically, lets in cool night air following hot days to help maintain a comfortable temperature throughout the day
- Fireplace mode, creating a temporary inside overpressure to enhance chimney functionality
- High-efficiency heat recovery
- EC fan motors with extremely low energy consumption (low SPI)
- Highly customisable units with the option to add a high variety of internal as well as external accessories
- Ducts can be connected through the top of the unit, either side or the bottom as preferred
- Compact design
- External pre-heater as accessory
- Free smartphone App available

Third party testing and certification

Code	Description
ErP	Compliant with EU regulations for Eco-design
Nordic Swan Ecolabel	Listed in the Nordic Swan database for products suitable for Ecolabelled buildings
PCDB listed SAP App. Q	Pending: Listed in the UK database for balanced whole-house mechanical ventilation with heat recovery
PHI	Passivhaus certified
EPB	Pending: Listed in the database for Energy Performance of Buildings in Belgium

WALL AND ATTIC-MOUNTED UNITS

RCV 320_{P1}

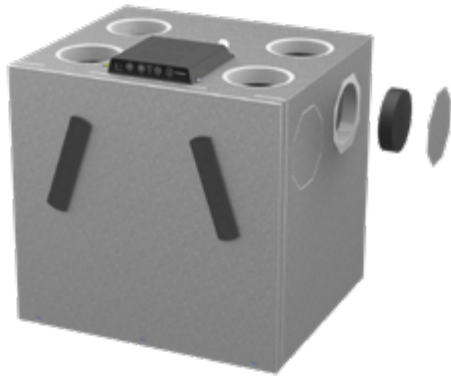

Flexible unit

The factory-mounted duct seals on the side of the unit can easily be removed using a side cutter and then used to seal off other ducts not to be used.

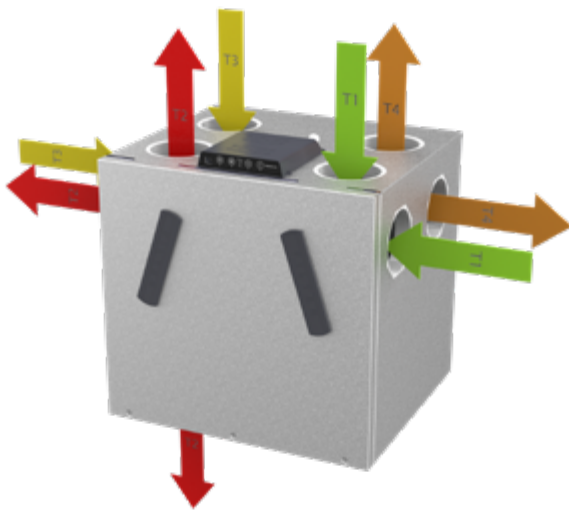

(A) LEFT SET-UP

Tired of having to redo ducting to fit ventilation units?

Unlike all other residential ventilation units on the market, the RCV offers a stunning 48 different ways of connecting ducts to the unit. 24 available combinations for left setups (A) and 24 for right setups (B). Simply choose whichever one is more convenient in terms of installation!

With this flexible unit, you'll be able to find a fast and cost-efficient way to finalise installation work, even in the trickiest of installation areas.

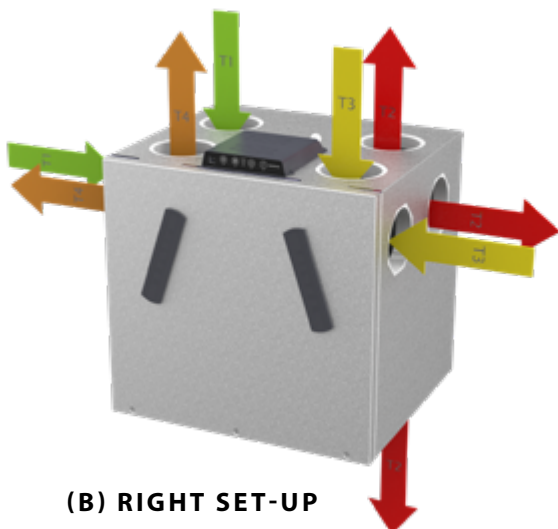

(B) RIGHT SET-UP

-  T1 Outdoor air
-  T2 Supply air
-  T3 Extract air
-  T4 Exhaust air

WALL AND ATTIC-MOUNTED UNITS

RCV 320_{P1}

TECHNICAL DATA

Specifications	Units		RCV 320P1
Maximum flow at 100Pa	V_{100Pa}	m ³ /h	320
Maximum rated flow at 100Pa	$V_{max. nom.}$	m ³ /h	200
Recommended operating range	V	m ³ /h	50 - 200
Operating range Passivhaus at 100Pa	V_{PHI}	m ³ /h	71 - 162
EN 13141-7 reference flow at 50Pa	V_{REF}	m ³ /h	140
Performance			
Thermal efficiency in accordance with PHI	η_{SUP}	%	94
Thermal efficiency in accordance with EN13141-7	η_{SUP}	%	95
Leakage (external and internal) in accordance with EN 13141-7	-	-	<2% (Class A1)
Filters in accordance with ISO16890	-	-	ISO Coarse 75% (optional on supply: ePM1>50%)
Filters in accordance with EN779:2012	-	-	G4 (optional on supply: F7)
Installation surrounding temperature	t_{SURR}	°C	-12 to +45
Outdoor temperature without preheater installed	t_{ODA}	°C	-12* to +45
Outdoor temperature with preheater installed	t_{ODA}	°C	-15 to +45
Maximum absolute humidity of extract air	x	g/kg	10
Cabinet			
Dimensions (without bracket)	w x h x d	mm	600 x 603 x 526**
Spigots/ducts connections	Ø	mm	8 pcs ø125 and 2 pcs oval (68 x 163) – female
Weight		kg	32
Thermal conductivity – polystyrene insulation	λ	W/mK	0.031
Heat transition figures – polystyrene insulation	U	W/m ² K	U<1
Fire classification of the polystyrene insulation	-	-	DIN 4102-1 class B2 EN 13501 class E
Drainage hose included	Ø/length	"/m	ø¾" – 1m
Cabinet colour	-	-	raw Alu-zinc
Electrical			
Voltage	U	V	230
Maximum power consumption (without/with preheater)	P	W	170/1370
Frequency	f	Hz	50
Protection class	-	-	IP21

* The use of preheating coil is recommended at outdoor temperature -3°C to ensure balanced operation.

** +20mm fitting.

RCV 320_{P1}

CAPACITY AND SPI CURVES WITH G4/G4 FILTERS

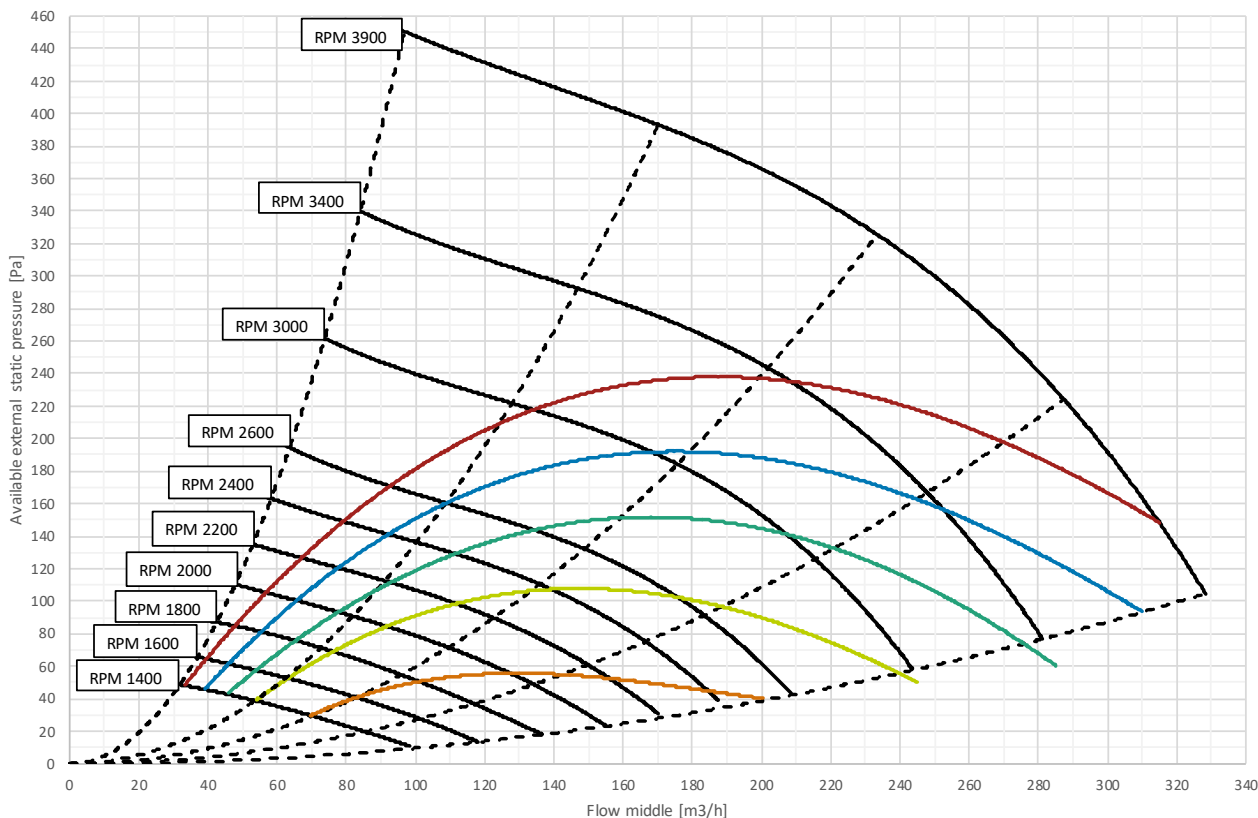

SFP/SPI/SEL*	0.45 W/m ³ /h	0.39 W/m ³ /h	0.33 W/m ³ /h	0.28 W/m ³ /h	0.22 W/m ³ /h
	1620 J/m ³	1400 J/m ³	1200 J/m ³	1000 J/m ³	800 J/m ³
	1.62 W/l/s	1.40 W/l/s	1.20 W/l/s	1.0 W/l/s	0.80 W/l/s

* SFP/SPI/SEL includes power consumption of both fans and the control.

THERMAL EFFICIENCY CURVES

- Thermal efficiency according to EN 13141-7 (dry)
Operational conditions: outdoor air: 7°C, 85% RH; extract air: 20°C, 37% RH
- Thermal efficiency according to EN 13141-7 (with condensation)
Operational conditions: outdoor air: 2°C, 85% RH; extract air: 20°C, 60% RH
- Thermal efficiency acc. PassivHaus Institut
Operational conditions: outdoor air: 4°C, 94% RH; extract air: 21°C, 30% RH

All values at balanced flow

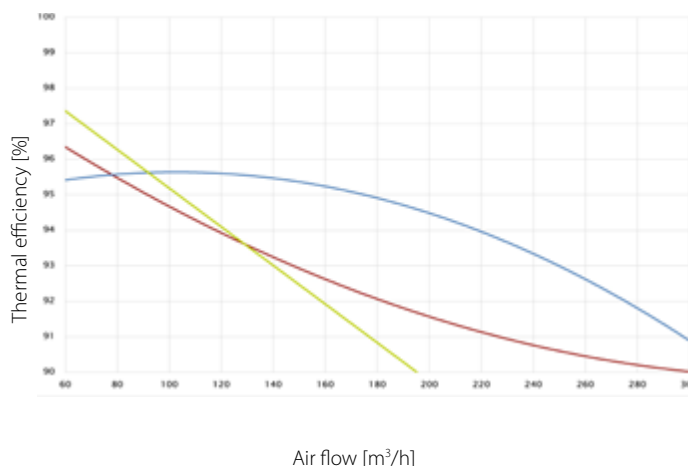

WALL AND ATTIC-MOUNTED UNITS

RCV 320_{P1}

SOUND POWER LEVEL (L_w) – DUCTS

RPM	Duct	[dB(A)]								
		63Hz	125Hz	250Hz	500Hz	1kHz	2kHz	4kHz	8kHz	Total
1200	supply/exhaust	23.6	33.1	32.8	34.0	30.0	20.8	13.3	18.5	39
	extract/outdoor	20.2	26.0	26.0	30.0	23.9	15.5	6.9	13.0	33
1400	supply/exhaust	26.2	36.1	37.0	37.2	34.4	24.6	19.0	18.6	42
	extract/outdoor	21.9	28.5	30.1	33.7	28.3	21.5	18.1	21.4	37
1600	supply/exhaust	27.8	36.7	41.0	40.2	37.6	28.8	22.0	19.1	45
	extract/outdoor	23.9	29.0	35.6	36.3	31.7	25.5	17.3	21.5	40
1800	supply/exhaust	30.2	38.1	46.1	43.1	40.6	32.1	24.9	13.3	49
	extract/outdoor	26.8	30.4	38.2	38.9	34.7	28.8	18.8	21.7	43
2000	supply/exhaust	32.0	39.8	49.4	45.8	43.5	35.2	28.5	13.0	52
	extract/outdoor	30.2	31.5	41.9	41.3	37.5	31.6	18.1	20.3	46
2200	supply/exhaust	34.2	40.9	51.0	48.1	46.0	38.1	31.8	12.7	54
	extract/outdoor	32.3	33.0	43.4	43.6	39.9	34.1	21.5	21.5	48
2400	supply/exhaust	35.4	42.3	54.4	50.1	47.6	40.6	34.7	18.7	57
	extract/outdoor	33.9	34.2	44.5	45.8	42.0	36.2	20.7	14.9	49
2600	supply/exhaust	38.6	43.9	55.8	52.4	49.7	43.1	37.5	19.7	58
	extract/outdoor	36.6	35.8	47.7	47.8	43.8	38.4	24.8	23.3	52
3000	supply/exhaust	40.1	45.6	59.0	62.5	53.1	47.0	41.9	26.9	65
	extract/outdoor	37.7	37.5	47.7	53.3	47.3	42.5	28.3	23.3	55
3400	supply/exhaust	43.8	51.4	62.4	68.8	57.0	50.2	45.7	31.9	70
	extract/outdoor	40.3	40.1	48.2	61.2	50.2	45.1	31.2	24.6	62

SOUND PRESSURE LEVEL (L_p) – CABINET

2m distance

RPM	Without background noise weighted [dB(A)]								
	63Hz	125Hz	250Hz	500Hz	1kHz	2kHz	4kHz	8kHz	Total
1000	-	2.6	9.5	12.9	9.6	5.8	1.4	3.0	17
1200	-	4.0	11.1	15.8	16.3	12.6	9.4	4.1	21
1400	-	7.1	13.9	17.6	16.4	12.6	5.3	1.7	22
1600	-	8.5	18.0	20.8	17.7	13.2	6.0	-0.1	24
1800	-	10.0	21.9	23.6	20.2	16.3	9.4	4.9	27
2000	-	11.5	22.4	25.7	22.2	18.3	11.6	5.6	29
2200	-	13.3	26.5	28.2	24.6	20.7	13.3	5.6	32
2400	-	18.5	28.1	30.9	27.7	24.4	17.5	5.6	35
2600	11.0	20.1	29.9	34.6	29.5	25.6	18.9	5.6	37
3000	11.1	20.2	32.3	37.9	32.1	29.0	22.8	9.0	40

WALL-MOUNTED UNITS

RCV 320_{P1}

DIMENSIONS

On the 320_{P1}, it is possible to connect the supply duct to the bottom if the ducts are to run beneath the floor.

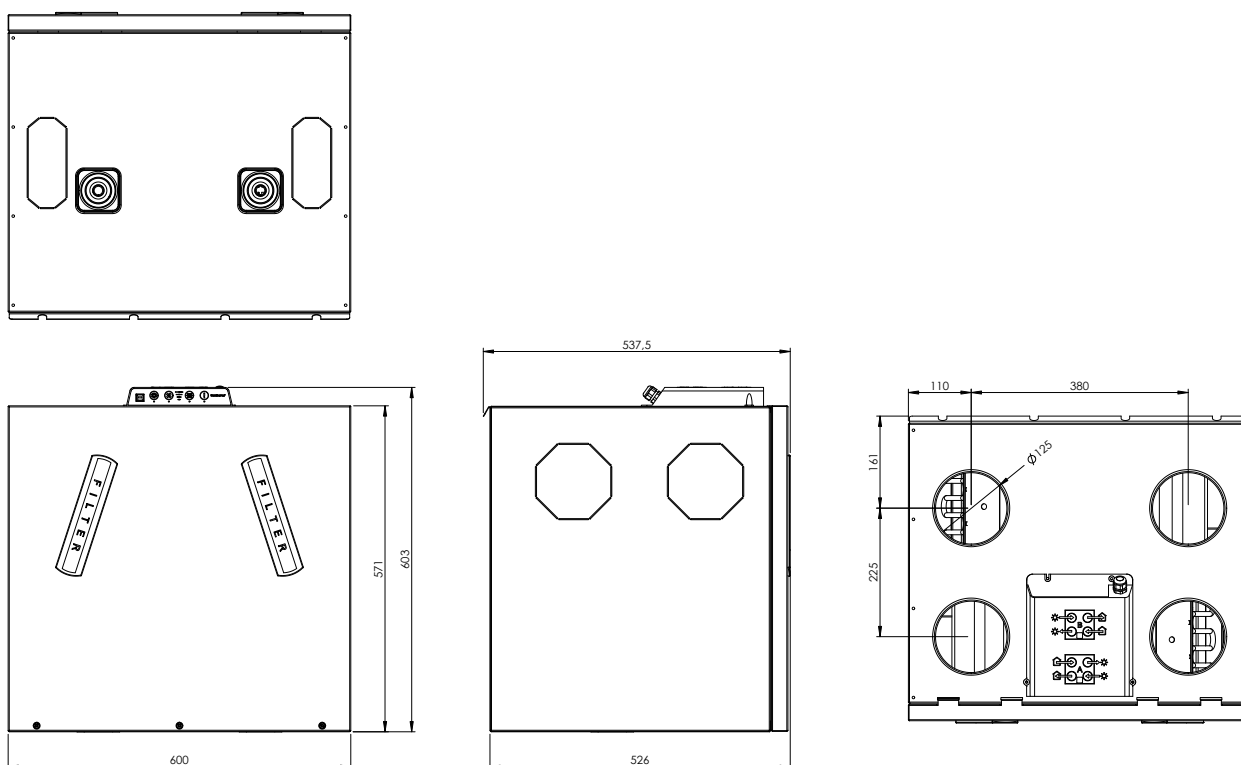

Revit files are available for free on request.
Contact your local supplier or Dantherm for access.

ATTIC AND WALL-MOUNTED UNITS

RCV 320_{P2}



The RCV 320 is a highly efficient and very compact residential ventilation unit for houses, villas, and apartments. Based on patent-pending technology and an ingenious design, it is delivered as a true plug and play solution with a built-in control panel and all necessary parts for on-site wall installation.

All units come with an Aluzinc surface finish and will be packaged four units on a pallet at a time to ease handling at building sites. In addition to speeding up your installation work, this reduces the amount of packaging materials for you to get rid of while also benefitting the environment.

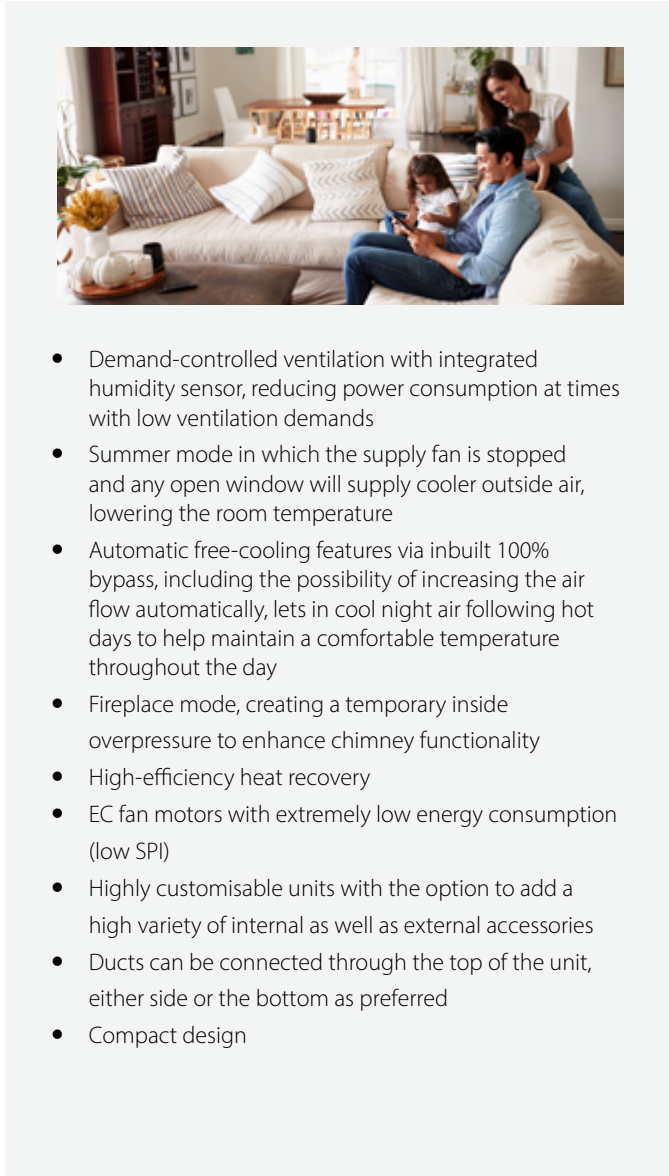

- Demand-controlled ventilation with integrated humidity sensor, reducing power consumption at times with low ventilation demands
- Summer mode in which the supply fan is stopped and any open window will supply cooler outside air, lowering the room temperature
- Automatic free-cooling features via inbuilt 100% bypass, including the possibility of increasing the air flow automatically, lets in cool night air following hot days to help maintain a comfortable temperature throughout the day
- Fireplace mode, creating a temporary inside overpressure to enhance chimney functionality
- High-efficiency heat recovery
- EC fan motors with extremely low energy consumption (low SPI)
- Highly customisable units with the option to add a high variety of internal as well as external accessories
- Ducts can be connected through the top of the unit, either side or the bottom as preferred
- Compact design

Third party testing and certification

Code	Description
ErP	Compliant with EU regulations for Eco-design
Nordic Swan Ecolabel	Listed in the Nordic Swan database for products suitable for Ecolabelled buildings

ATTIC AND WALL-MOUNTED UNITS

RCV 320_{P2}

TECHNICAL DATA

Specifications	Units		RCV 320 _{P2}
Maximum flow	V_{100Pa}	m ³ /h	320
Maximum rated flow	$V_{max. nom.}$	m ³ /h	200
Recommended operating range	V	m ³ /h	50 - 200
EN 13141-7 reference flow at 50Pa	V_{ref}	m ³ /h	140
Performance			
Thermal efficiency in accordance with EN13141-7	η_{SUP}	%	90
Leakage (external and internal) in accordance with EN 13141-7	-	-	<2% (Class A1)
Filters in accordance with ISO16890	-	-	ISO Coarse 75% (optional on supply: ePM1>50%)
Filters in accordance with EN779	-	-	G4 (optional on supply: F7)
Installation surrounding temperature	t_{SURR}	°C	-12 to +45
Outdoor temperature without preheater installed	t_{ODA}	°C	-12* to +40
Outdoor temperature with preheater installed	t_{ODA}	°C	-20 to +40
Maximum absolute humidity of extract air	x	g/kg	10
Cabinet			
Dimensions (without bracket)	w x h x d	mm	600 x 603 x 526**
Spigots/ducts connections	Ø	mm	8 pcs ø125 and 2 pcs oval (68 x 163) – female
Weight		kg	32
Thermal conductivity – polystyrene insulation	λ	W/mK	0.031
Heat transition figures – polystyrene insulation	U	W/m ² K	U<1
Fire classification of the polystyrene insulation	-	-	DIN 4102-1 class B2 EN 13501 class E
Drainage hose included	Ø/length	"/m	ø¾" – 1m
Cabinet colour	RAL	-	no paint/raw Alu-zinc
Electrical			
Voltage	U	V	230
Maximum power consumption (without/with preheater)	P	W	170/1070
Frequency	f	Hz	50
Protection class	-	-	IP21

* The use of preheating coil is recommended at outdoor temperature -3°C to ensure balanced operation.

** +20mm fitting.

CAPACITY AND SPI CURVES WITH G4/G4 FILTERS

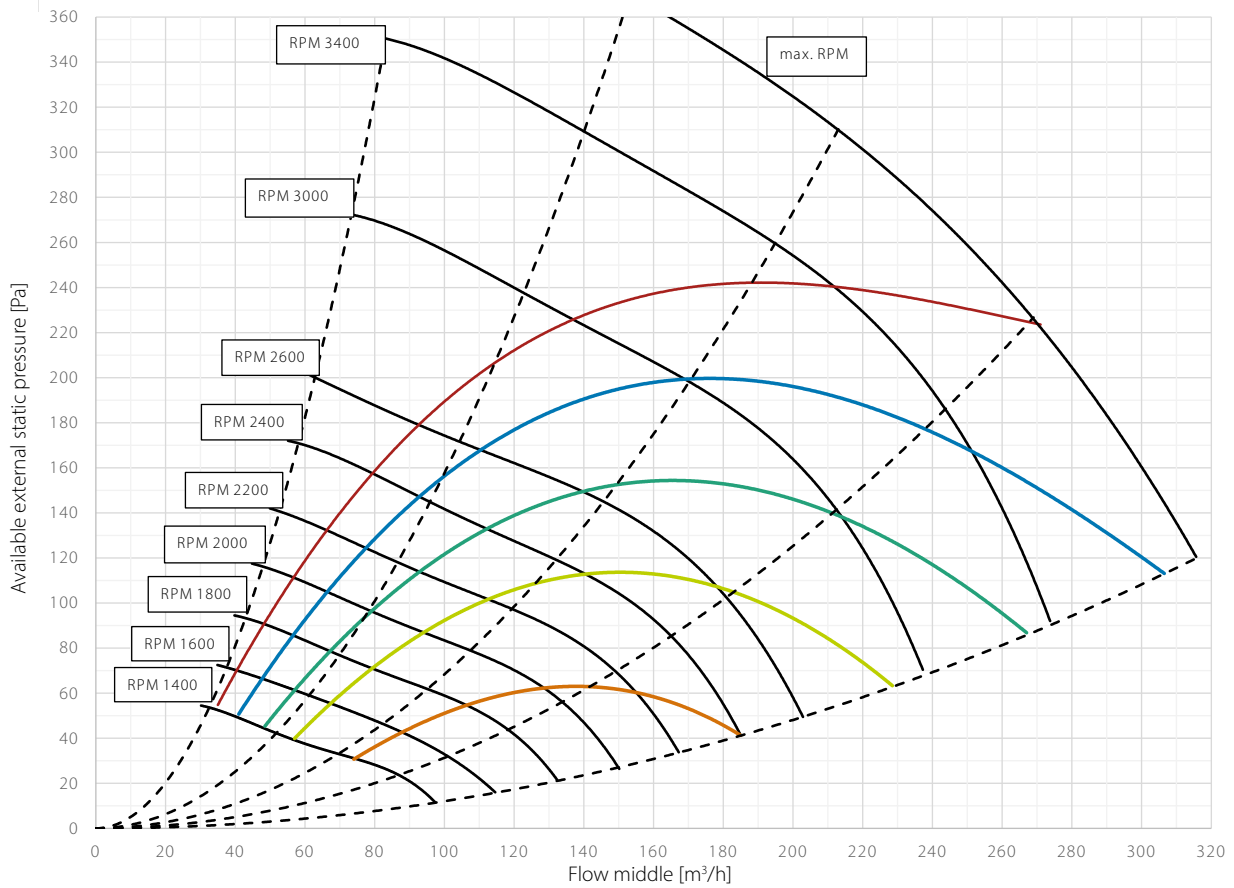

	—	—	—	—	—
SFP/SPI/SEL*	0.45 W/m ³ /h	0.39 W/m ³ /h	0.33 W/m ³ /h	0.28 W/m ³ /h	0.22 W/m ³ /h
	1620 J/m ³	1400 J/m ³	1200 J/m ³	1000 J/m ³	800 J/m ³
	1.62 W/l/s	1.40 W/l/s	1.20 W/l/s	1.0 W/l/s	0.80 W/l/s

* SFP/SPI/SEL includes power consumption of both fans and the control.

THERMAL EFFICIENCY CURVES

Legend

- Thermal efficiency according to EN 13141-7 (dry)
Operational conditions: outdoor air: 7°C, 85% RH; extract air: 20°C, 37% RH

All values at balanced flow

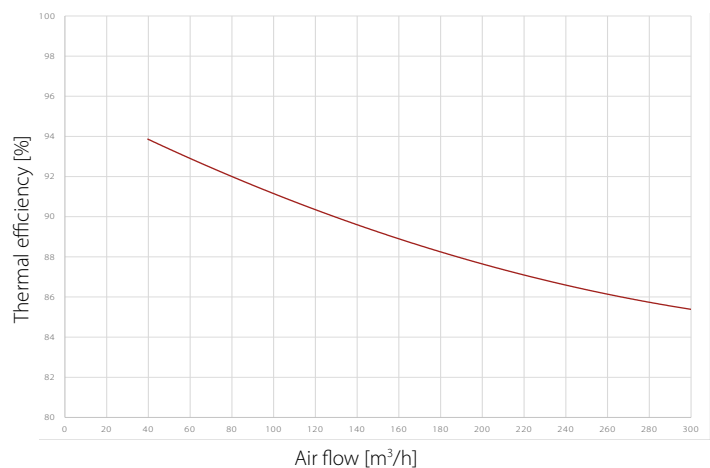

ATTIC AND WALL-MOUNTED UNITS

RCV 320_{P2}

SOUND POWER LEVEL (L_w) – DUCTS

RPM	Duct	[dB(A)]								
		63Hz	125Hz	250Hz	500Hz	1kHz	2kHz	4kHz	8kHz	Total
1200	supply/exhaust	23.6	33.1	32.8	34.0	30.0	20.8	13.3	18.5	39
	extract/outdoor	20.2	26.0	26.0	30.0	23.9	15.5	6.9	13.0	33
1400	supply/exhaust	26.2	36.1	37.0	37.2	34.4	24.6	19.0	18.6	42
	extract/outdoor	21.9	28.5	30.1	33.7	28.3	21.5	18.1	21.4	37
1600	supply/exhaust	27.8	36.7	41.0	40.2	37.6	28.8	22.0	19.1	45
	extract/outdoor	23.9	29.0	35.6	36.3	31.7	25.5	17.3	21.5	40
1800	supply/exhaust	30.2	38.1	46.1	43.1	40.6	32.1	24.9	13.3	49
	extract/outdoor	26.8	30.4	38.2	38.9	34.7	28.8	18.8	21.7	43
2000	supply/exhaust	32.0	39.8	49.4	45.8	43.5	35.2	28.5	13.0	52
	extract/outdoor	30.2	31.5	41.9	41.3	37.5	31.6	18.1	20.3	46
2200	supply/exhaust	34.2	40.9	51.0	48.1	46.0	38.1	31.8	12.7	54
	extract/outdoor	32.3	33.0	43.4	43.6	39.9	34.1	21.5	21.5	48
2500	supply/exhaust	35.4	42.3	54.4	50.1	47.6	40.6	34.7	18.7	57
	extract/outdoor	33.9	34.2	44.5	45.8	42.0	36.2	20.7	14.9	49
2700	supply/exhaust	38.6	43.9	55.8	52.4	49.7	43.1	37.5	19.7	58
	extract/outdoor	36.6	35.8	47.7	47.8	43.8	38.4	24.8	23.3	52
2900	supply/exhaust	40.1	45.6	59.0	62.5	53.1	47.0	41.9	26.9	65
	extract/outdoor	37.7	37.5	47.7	53.3	47.3	42.5	28.3	23.3	55

RCV 320_{P2}SOUND PRESSURE LEVEL (L_P) – CABINET

2m distance

RPM	[dB(A)]								
	63Hz	125Hz	250Hz	500Hz	1kHz	2kHz	4kHz	8kHz	Total
1000	-	2.6	9.5	12.9	9.6	5.8	1.4	3.0	17
1200	-	4.0	11.1	15.8	16.3	12.6	9.4	4.1	21
1400	-	7.1	13.9	17.6	16.4	12.6	5.3	1.7	22
1600	-	8.5	18.0	20.8	17.7	13.2	6.0	-0.1	24
1800	-	10.0	21.9	23.6	20.2	16.3	9.4	4.9	27
2000	-	11.5	22.4	25.7	22.2	18.3	11.6	5.6	29
2200	-	13.3	26.5	28.2	24.6	20.7	13.3	5.6	32
2400	-	18.5	28.1	30.9	27.7	24.4	17.5	5.6	35
2600	11.0	20.1	29.9	34.6	29.5	25.6	18.9	5.6	37
3000	11.1	20.2	32.3	37.9	32.1	29.0	22.8	9.0	40

ATTIC AND WALL-MOUNTED UNITS

RCV 320_{P2}

DIMENSIONS

On the RCV 320, it is possible to connect the supply duct to the bottom if the ducts are to run beneath the floor.

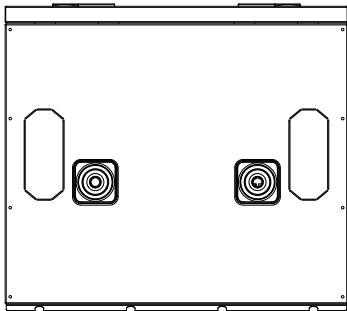

REVIT

Revit files are available for free on request. Contact your local supplier or Dantherm for access.

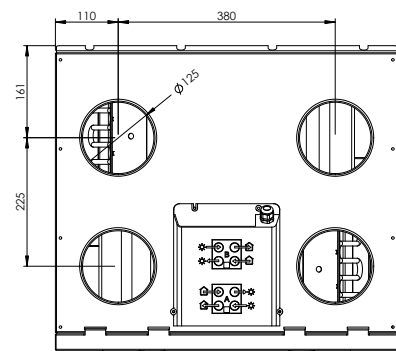
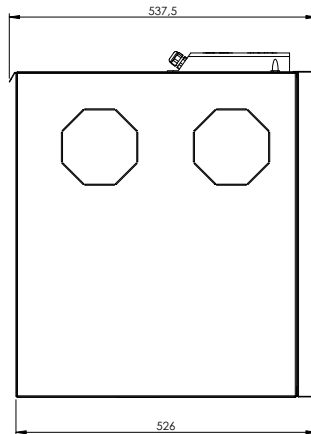
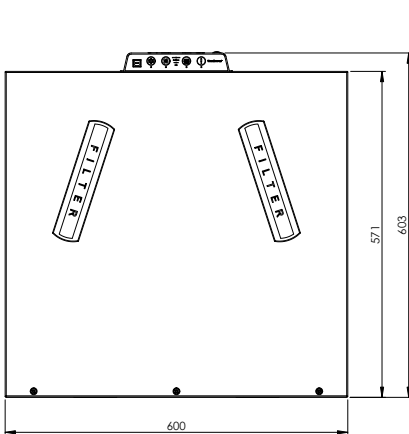

DUCT CONNECTIONS

(A) LEFT SET-UP
Factory set-up

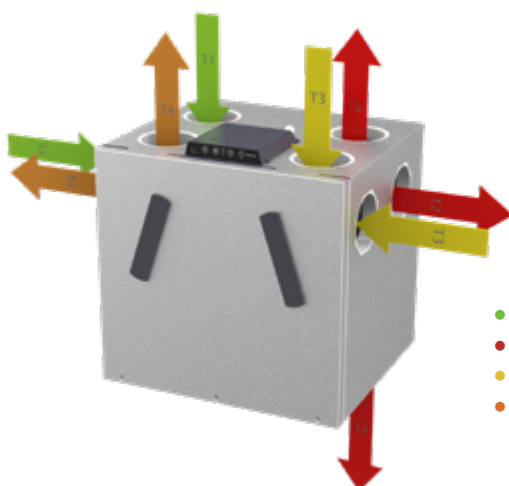

(B) RIGHT SET-UP Optional -
easy change on site

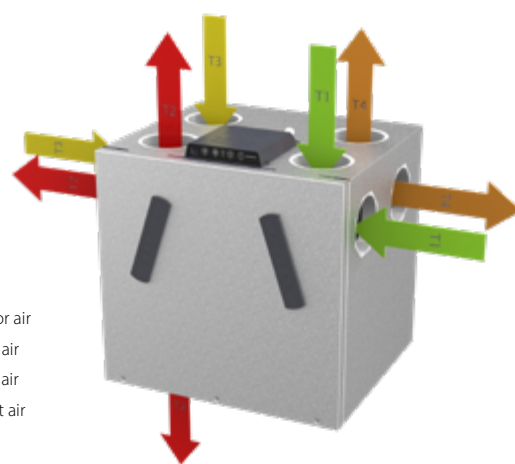

- T1 Outdoor air
- T2 Supply air
- T3 Extract air
- T4 Exhaust air

ATTIC AND WALL-MOUNTED UNITS HCH RANGE



For a quick selection of the product range you can use the selection chart below. The selection chart shows the air volumes at 100Pa pressure loss.

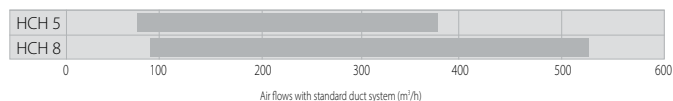

Overview

The HCH residential ventilation units are primarily designed for 1 and 2 family houses. The units are supplied as packaged ventilation units complete with built-in demand-control and a control panel. The residential ventilation units are fitted with highly efficient counter-flow heat exchangers which are optimised to a very high efficiency level thus achieving a very low specific fan power (SFP value) for the entire unit.

For a quick selection you can use the selection chart below. The selection chart shows the air volumes when operating with a normal duct system with normal pressure drop.

All HCH models are fully operational in surrounding temperatures down to -12°C.

The HCH residential ventilation units are horizontal models designed to be fitted in the loft or on the floor of a plant room. They fulfil the ventilation requirements of houses up to approximately 475m², depending on national requirements and the actual pressure loss in the installation.

All HCH models have duct connections at the ends and service access at the front. Electrical connection is at the end of the unit facing the fresh air – right-hand – side. The ducts connected to the home (supply and extract) are always on the left-hand side of the unit. The condensation drain is located at the rear of the unit.



ATTIC AND WALL-MOUNTED UNITS

HCH RANGE

Filters

All models use 50mm G4 compact filters as standard for both supply air and extract air. This will cater for the majority of air cleaning needs. The advantage of compact filters is that they have a considerably larger filter surface area than fibrous filters and small bag filters. The filter thus works for longer and under normal conditions, it will not need changing more than twice a year, equivalent to the filter timer setting.

If necessary, F7 filters (pollen filters) are available as accessories, which ensure that allergens do not enter the home through the ventilation system.



PANEL FILTERS



CHANGING THE HCH FILTER

Installation

Measurement and adjustment of air volumes is done via pressure nozzles and PC-tool. A performance graph is adhered to the polystyrene front showing the pressure and air volumes the installer must use to determine the correct fan speeds. The label also has a space for the installer to write in the air volumes, the back pressure and fan speeds to which the system has been adjusted.

Operation

The two horizontal models HCH 5 and HCH 8 are operated via the control panel. It is recommended to connect an App or HCP11 so that the status of the unit can be seen/heard and adjusted.

Safety operation – connection to a smoke or fire alarm system

It is possible to connect a standard smoke/fire alarm system to the HCH residential ventilation unit. When activated, the alarm system will give a fire alarm signal and stop both fans to avoid more smoke/fire to enter from outside. Once the smoke/fire danger is no longer present, the unit must be restarted manually by reset button on foil panel..

When desired (due to higher risk of smoke/fire or higher safety requirements), it is also possible to build duct dampers into the duct work and have the ventilation unit open/close these whenever the unit is running/stopped. The damper motors (one for supply and one for extract air) can be powered and controlled by the accessory controller FPC (Fire Protections Controller).

Service and maintenance

In general, the only regular maintenance required by HCH products is to check/change the air filters twice a year, when the alarm LED blinks yellow and the acoustic alarm bleeps once an hour. On the HCH models, the front panel is removed, after which the two filters can be changed and the filter timer reset.

Apart from changing the air filters and cleaning the outside of the unit, any other form of service will have to be carried out by qualified personnel. Local Dantherm technicians and Dantherm partners are always available to solve any problem with the unit that might arise.

ATTIC AND WALL-MOUNTED UNITS

HCH 5



The HCH 5 residential ventilation units are primarily designed for 1-2 family houses. The units are supplied as packaged ventilation units complete with built-in demand-control and a control panel. The residential ventilation units are fitted with highly efficient counter-flow heat exchangers which are optimised to a very high efficiency level thus achieving a very low specific fan power (SFP value) for the entire unit.



- Demand-controlled ventilation with integrated humidity sensor, reducing power consumption at times with low ventilation demands
- High-efficiency heat recovery
- EC motors with extremely low energy consumption (low SFP)
- Easy-to-install solution with pressure pipes for air volume measurement and adjustment via PC-Tool
- HCH models are suitable for installation on uninsulated attics
- Summer mode in which the supply fan is stopped and any open window will supply cooler outside air, lowering the room temperature
- Automatic free-cooling features via inbuilt 100% bypass, including the possibility of increasing the air flow automatically, lets in cool night air following hot days to help maintain a comfortable temperature throughout the day
- Fireplace mode, creating a temporary inside overpressure to enhance chimney functionality
- Highly customisable units with the option to add a high variety of internal as well as external accessories
- Internal pre-heater as accessory

Third party testing and certifications

Code	Description
PHI	Passivhaus certified
PCDB listed SAP App. Q	Listed in the UK database for balanced whole-house mechanical ventilation with heat recovery
DIBt	Certified by the German Institute of Construction Technology
EPB	Listed in the database for Energy Performance of Buildings in Belgium
ErP	Compliant with EU regulations for Eco-design
Nordic Swan Ecolabel	Listed in the Nordic Swan database for products suitable for Ecolabelled buildings

ATTIC AND WALL-MOUNTED UNITS

HCH 5

TECHNICAL DATA

Specifications	Units	HCH 5
Performance		
Max. flow at 100Pa	m ³ /h	350
Max. rated flow at 100Pa	V _{max.rated} + m ³ /h	300
Recommended operating range	V + m ³ /h	80 - 300
EN 13141-7 reference flow at 50Pa	V _{REF} + m ³ /h	210
Energy consumption class – average climate	SEC-class	A
Energy consumption class – average climate	SEC-class	A+ *
Heat exchanger type		Dantherm aluminium counter-flow heat exchanger
Thermal efficiency		Up to 94%**
Bypass		Yes
Filters in accordance with EN779		G4 (optional on supply: F7)
Filters in accordance with ISO 16890		ISO Coarse 75% (optional on supply: ePM1>50%)
Surrounding temperature where the unit is installed	°C	-12 to +50
Operational temperature range without preheating	°C	-13*** to +50
Operational temperature range with preheating	°C	-20 to +50
Leakage (external and internal) according to EN 13141-7	class	<2% (Class A1)
Cabinet		
Dimensions (w x h x d)	mm	1180 x 600 x 580
Duct connection	mm	160
Weight unit	kg	52
Weight including packaging	kg	66
Dimensions including packaging and pallet (w x d x h)	mm	1210 x 610 x 750
Outer cabinet material		Aluzinc
Colour	RAL	Alzunik grey
Cabinet insulation, polystyrene	mm	40
Insulation factor – cabinet	W/m ² x °K	0.78
Fire classification – polystyrene cabinet	DIN 4102	class B1
Fire classification – whole unit	EN 13501	class E
Protection class		IP20
Electrical data		
Supply voltage	V	1 x 230
Frequency	Hz	50
Maximum power consumption (without/with preheater)	W	154/1554

* Requires an Energy Efficiency Class A+ kit (including CO₂ sensor and HAC 1 accessory control). Described under Accessories.

** Condensing operation.

*** We recommend preheating at temperatures under -3°C to ensure a balanced operation.

ATTIC AND WALL-MOUNTED UNITS HCH 5

CAPACITY AND SPI CURVES WITH G4/G4 FILTERS

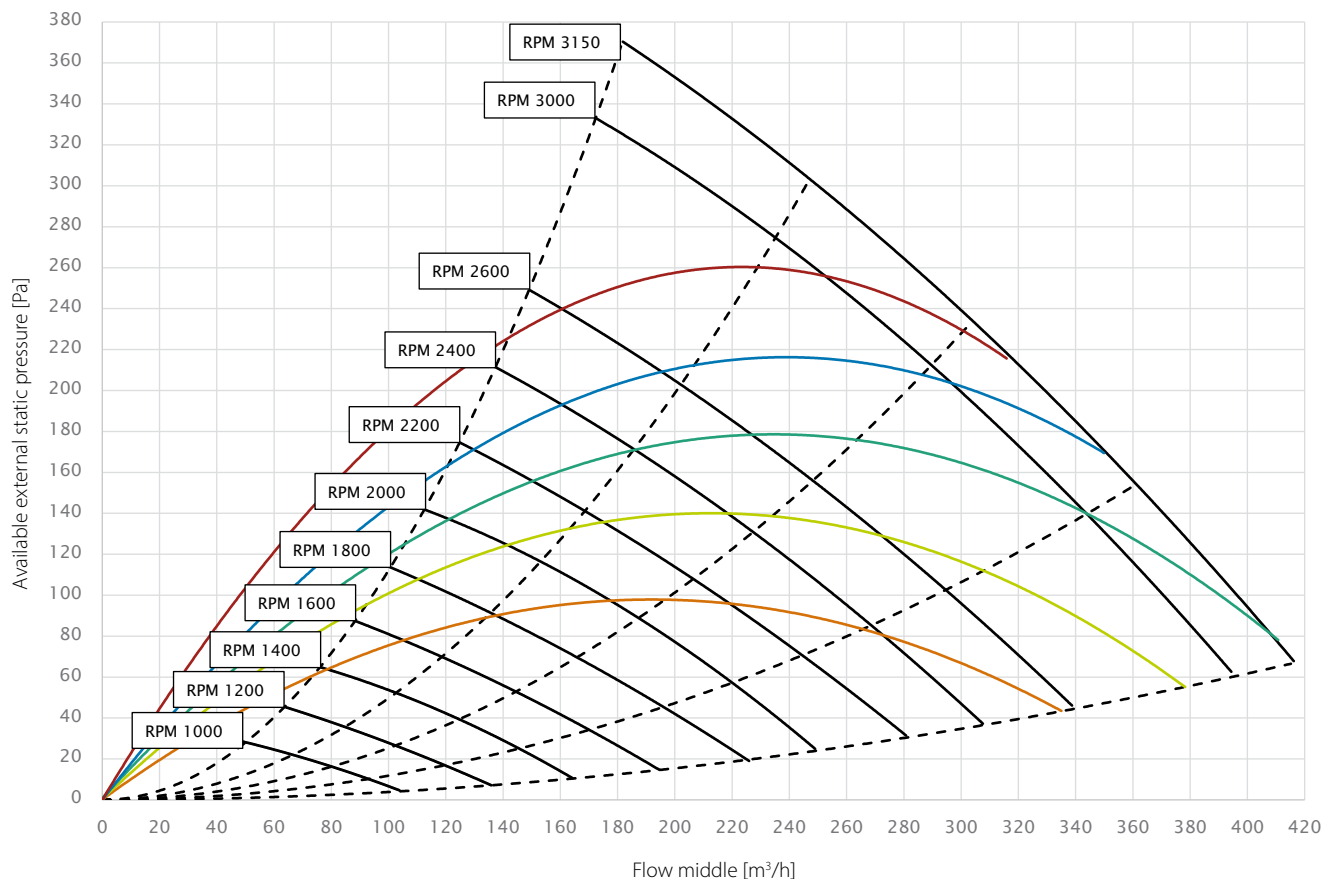

	—	—	—	—	—
SFP/SPI/SEL*	0.45 W/m ³ /h	0.39 W/m ³ /h	0.33 W/m ³ /h	0.28 W/m ³ /h	0.22 W/m ³ /h
	1620 J/m ³	1400 J/m ³	1200 J/m ³	1000 J/m ³	800 J/m ³
	1.62 W/l/s	1.40 W/l/s	1.20 W/l/s	1.0 W/l/s	0.80 W/l/s

* SFP/SPI/SEL includes power consumption of both fans and the control.

THERMAL EFFICIENCY CURVES

Legend

- Thermal efficiency according to EN 13141-7 (dry)
Operational conditions: outdoor air: 7°C, 80% RH; extract air: 20°C, 38% RH
- Thermal efficiency (with condensation)
Operational conditions: outdoor air: -10°C, 50% RH; extract air: 25°C, 55% RH
- Thermal efficiency according Passivhaus Institut
Operational conditions: outdoor air: 4°C, 90% RH; extract air: 21°C, 32% RH

All values at balanced flow

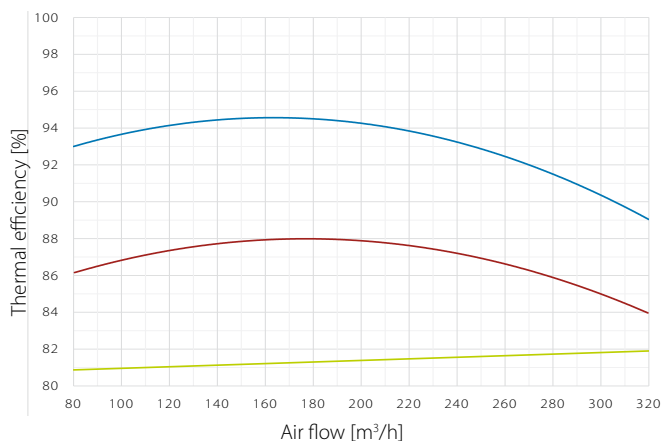

HCH 5

SOUND DATA WITH G4/G4 FILTERS

Flow m ³ /h	Pressure Pa	Measure Point	Frequency band sound power Lw dB(A)								Total sound power Lw dB(A)	Sound pressure Standard room* Lp dB(A)
			63Hz	125Hz	250Hz	500Hz	1000Hz	2000Hz	4000Hz	8000Hz		
162	70	Supply air duct	23	34	40	36	29	25	17	18	42	
		Extract air duct	23	33	39	37	29	24	18	18	42	
		Cabinet	22	31	39	41	31	29	23	21		40
	100	Supply air duct	25	35	43	38	31	28	18	18	45	
		Extract air duct	25	36	42	39	40	25	17	18	45	
		Cabinet	23	34	41	42	33	31	24	21		41
216	70	Supply air duct	26	36	44	39	33	30	19	18	46	
		Extract air duct	28	36	43	41	34	29	18	18	46	
		Cabinet	28	35	45	44	37	35	27	21		45
	100	Supply air duct	26	37	44	40	34	31	19	18	47	
		Extract air duct	27	37	45	42	35	30	19	18	48	
		Exhaust air duct	34	43	52	52	47	51	38	21	57	
		Cabinet	26	34	46	45	38	36	28	21		46
250	100	Supply air duct	28	39	46	42	37	33	21	18	49	
		Extract air duct	30	39	48	45	38	33	20	18	50	
		Cabinet	28	36	50	48	41	39	32	22		49

* Standard room = room with 10m² floor, 2.4m ceiling height, mean absorption 0.2.

ATTIC AND WALL-MOUNTED UNITS HCH 5

DIMENSIONS

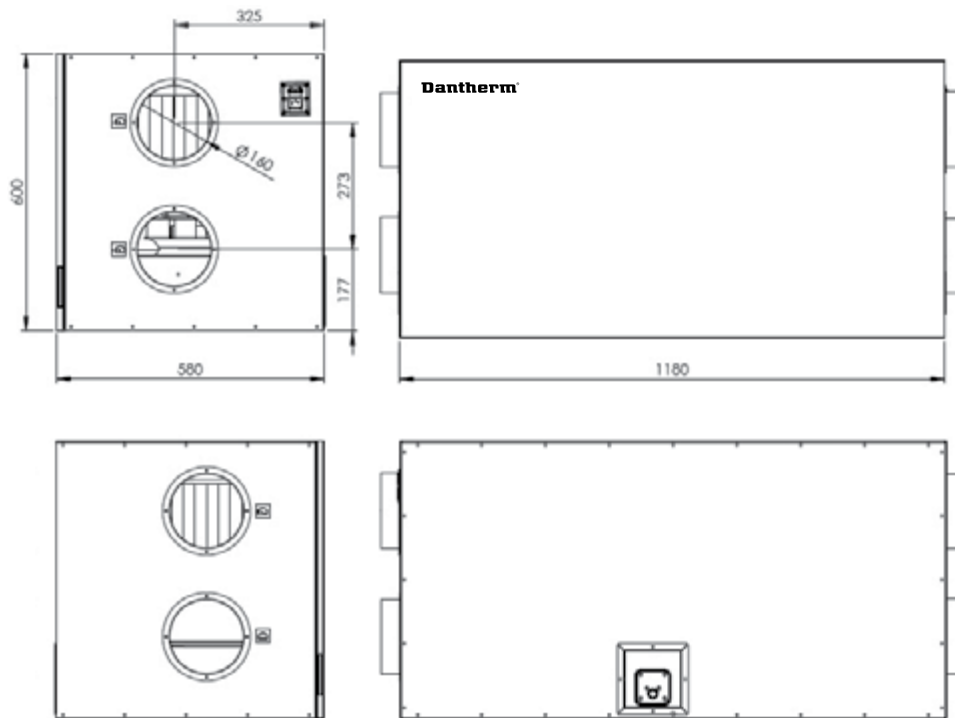

DUCT CONNECTIONS



ATTIC AND WALL-MOUNTED UNITS

HCH 8



The HCH 8 residential ventilation units are primarily designed for 1-2 family houses. The units are supplied as packaged ventilation units complete with built-in demand-control and a control panel. The residential ventilation units are fitted with highly efficient counter-flow heat exchangers which are optimised to a very high efficiency level thus achieving a very low specific fan power (SFP value) for the entire unit.



- Demand-controlled ventilation with integrated humidity sensor, reducing power consumption at times with low ventilation demands
- High-efficiency heat recovery
- EC motors with extremely low energy consumption (low SFP)
- Easy-to-install solution with pressure pipes for air volume measurement and adjustment via PC-Tool
- HCH models are suitable for installation on uninsulated attics
- Summer mode in which the supply fan is stopped and any open window will supply cooler outside air, lowering the room temperature
- Automatic free-cooling features via inbuilt 100% bypass, including the possibility of increasing the air flow automatically, lets in cool night air following hot days to help maintain a comfortable temperature throughout the day
- Fireplace mode, creating a temporary inside overpressure to enhance chimney functionality
- Highly customisable units with the option to add a high variety of internal as well as external accessories
- Internal pre-heater as accessory

Third party testing and certifications

Code	Description
PHI	Passivhaus certified
PCDB listed SAP App. Q	Listed in the UK database for balanced whole-house mechanical ventilation with heat recovery
DIBt	Certified by the German Institute of Construction Technology
EPB	Listed in the database for Energy Performance of Buildings in Belgium
ErP	Compliant with EU regulations for Eco-design
Nordic Swan Ecolabel	Listed in the Nordic Swan database for products suitable for Ecolabelled buildings

ATTIC AND WALL-MOUNTED UNITS

HCH 8

TECHNICAL DATA

Specifications	Units	HCH 8
Performance		
Max. flow at 100Pa	m ³ /h	500
Max. rated flow at 100Pa	V _{max.rated} + m ³ /h	500
Recommended operating range	V + m ³ /h	80 - 500
EN 13141-7 reference flow at 50Pa	V _{REF} + m ³ /h	350
Energy consumption class – average climate	SEC-class	A
Energy consumption class – average climate	SEC-class	A ⁺ *
Heat exchanger type		Dantherm aluminium counter-flow heat exchanger
Thermal efficiency		Up to 92% **
Bypass		Yes
Filters in accordance with EN779		G4 (optional on supply: F7)
Filters in accordance with ISO 16890		ISO Coarse 75% (optional on supply: ePM1>50%)
Surrounding temperature where the unit is installed	°C	-20 to +50
Operational temperature range without preheating	°C	-13 *** to +50
Operational temperature range with preheating	°C	-20 to +50
Leakage (external and internal) according to EN 13141-7	class	<2% (Class A1)
Cabinet		
Height	mm	600
Width	mm	1180
Depth (standard mounting rail/rail for plan mounting)	mm	780
Duct connection	mm	250
Weight, unit	kg	70
Weight including packaging	kg	84
Dimensions including packaging and pallet (w x d x h)	mm	1200 x 800 x 775
Outer cabinet material		Aluzinc
Colour	RAL	Alzunik grey
Cabinet insulation – polystyrene	mm	40
Insulation factor – cabinet	W/m ² x °K	0.78
Fire classification – polystyrene cabinet		DIN 4102 class B1
Fire classification – whole unit		EN 13501 class E
Protection class		IP20
Electrical data		
Supply voltage	V	1 x 230
Frequency	Hz	50
Max. current consumption, without pre- and after-heat	A	1.1
Max. power consumption, without pre- and after-heat	W	246

* Requires an Energy Efficiency Class A+ kit (including CO₂ sensor and HAC 1 accessory control). Described under Accessories.

** Condensing operation.

*** We recommend preheating at temperatures under -3°C to ensure a balanced operation.

ATTIC AND WALL-MOUNTED UNITS HCH 8

CAPACITY AND SPI CURVES WITH G4/G4 FILTERS

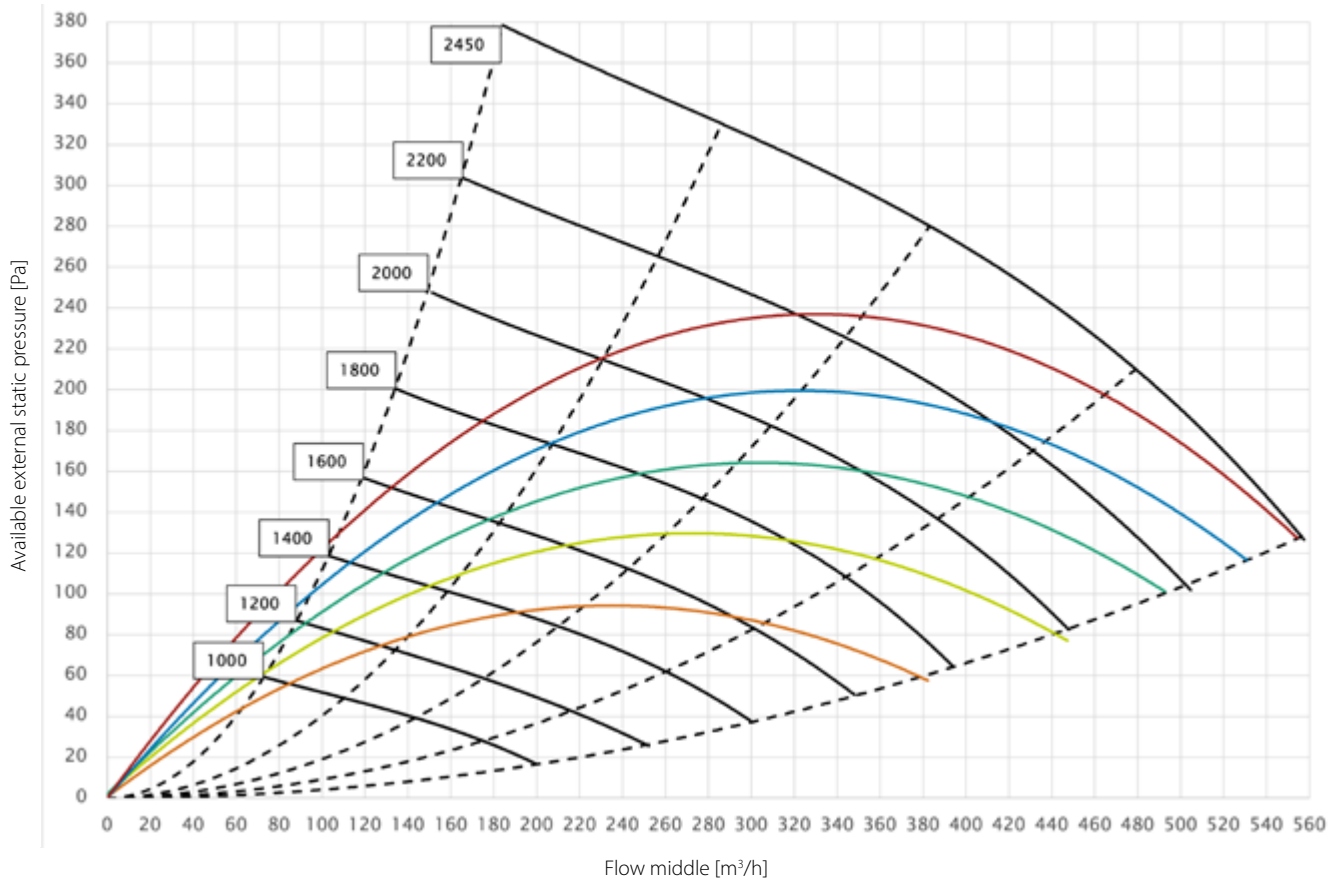

	—	—	—	—	—
SFP/SPI/SEL*	0.45 W/m ³ /h	0.39 W/m ³ /h	0.33 W/m ³ /h	0.28 W/m ³ /h	0.22 W/m ³ /h
	1620 J/m ³	1400 J/m ³	1200 J/m ³	1000 J/m ³	800 J/m ³
	1.62 W/l/s	1.40 W/l/s	1.20 W/l/s	1.0 W/l/s	0.80 W/l/s

* SFP/SPI/SEL includes power consumption of both fans and the control.

THERMAL EFFICIENCY CURVES

Legend

- Thermal efficiency according to EN 13141-7 (dry)
Operational conditions: outdoor air: 7°C, 80% RH; extract air: 20°C, 38% RH
- Thermal efficiency (with condensation)
Operational conditions: outdoor air: -10°C, 50% RH; extract air: 25°C, 55% RH
- Thermal efficiency according Passivhaus Institut
Operational conditions: outdoor air: 4°C, 90% RH; extract air: 21°C, 32% RH

All values at balanced flow

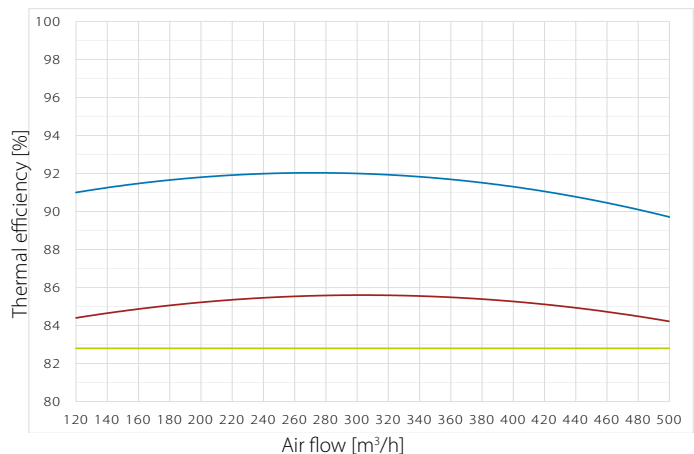

HCH 8

SOUND DATA WITH G4/G4 FILTERS

Flow m ³ /h	Pressure Pa	Measure Point	Frequency band sound power Lw dB(A)								Total sound power Lw dB(A)	Sound pressure Standard room* Lp dB(A)
			63Hz	125Hz	250Hz	500Hz	1000Hz	2000Hz	4000Hz	8000Hz		
			350	100	Supply air duct	44	51	56	50	43		
		Extract air duct	41	47	48	46	41	36	23	2	59	
		Cabinet	26	37	52	43	40	37	23	17		
450	100	Supply air duct	39	48	62	55	52	50	37	22	67	61
		Extract air duct	39	47	61	55	53	48	37	20	66	
		Cabinet	38	46	60	52	50	47	36	22		

* Standard room = room with 10m² floor, 2.4m ceiling height, mean absorption 0.2.

DIMENSIONS

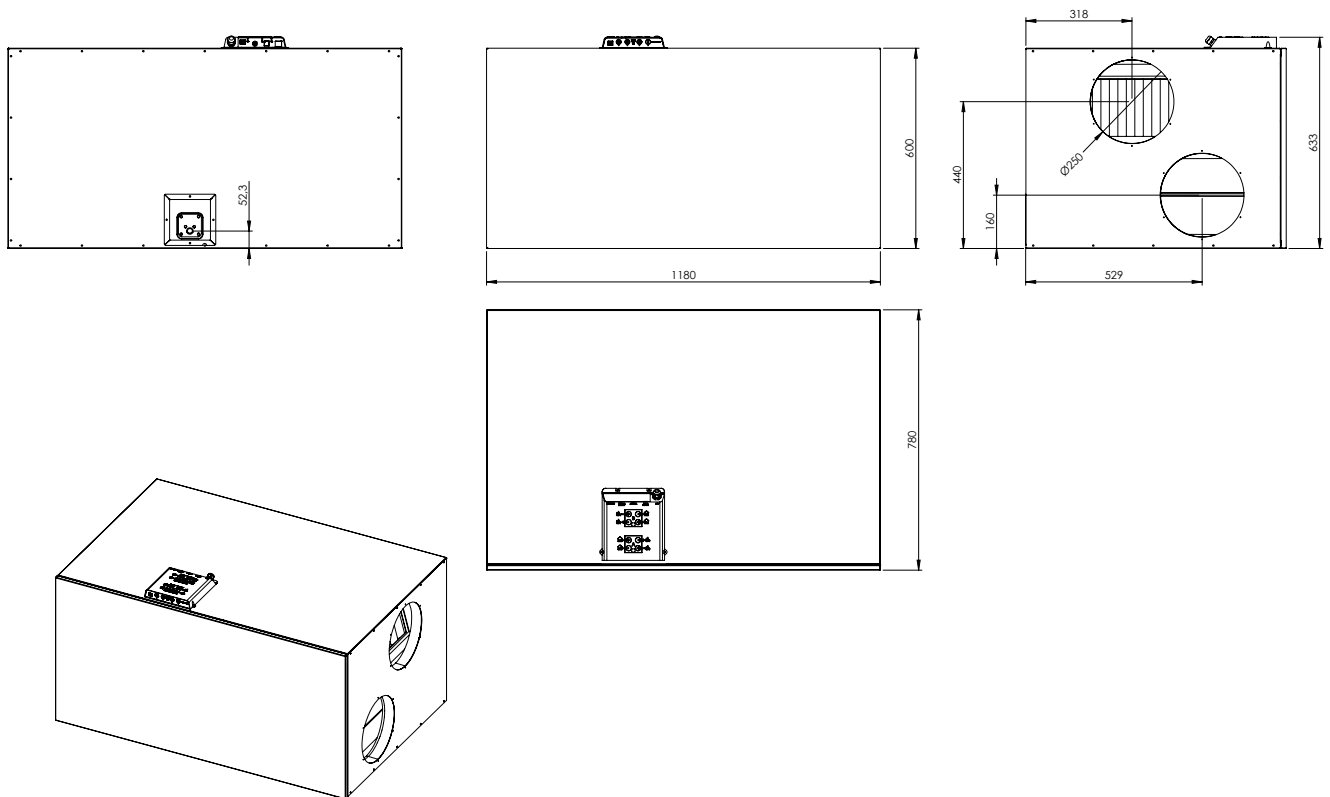

ACCESSORIES



ACCESSORIES

QUICK GUIDE

PRODUCTS SUITABILITY

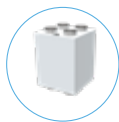

SILENCER

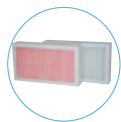

FILTERS



WATER HEATING COILS



PRE/AFTER HEATERS



HCV



RCV



HCC



HCH



ACCESSORIES

QUICK GUIDE

PRODUCTS SUITABILITY

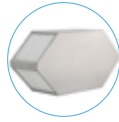

ENTHALPY HEAT EXCHANGERS



PLUGS AND CABLES



INSTALLATION ACCESSORIES



DISPLAY KITS



HCV



RCV



HCC



HCH



ACCESSORIES

SILENCER

The HCV 400-460 Silencer Box reduces fan and air flow noise before it is carried into the duct system. It is made of Aluzinc painted in colour RAL 9016. The ends of the sound attenuators are fitted with coupling connections and can be mounted directly on top of the HCV 400 or HCV 460 residential ventilation units.

Illustration	Accessory	Description	HCV 300	HCV 400	HCV 460	HCV 500	HCV 700	HCH 5	HCH 8	RCV 320	HCC 2	HCC 260 P1	HCC 360 E1
	096978	Silencer Box The HCV 400-460 Silencer Box reduces fan and air flow noise before it is carried into the duct system.		•	•								



HCV 400 with Silencer Box

Key features

- Discreet design with same width, depth and colour as HCV 400 unit
- Significant sound attenuation is achieved on all four ducts
- Plug-and-Play solution that fits direct to the top of the HCV 400 unit
- All four ducts in the Silencer Box are thermally and acoustically insulated and prepared for HCV 400 left and right configuration of duct work to reduce installation time
- Easy cabling at the top of the HCV 400 unit, because the front lid of the silencer can be removed
- Pressure loss is negligible
- Includes circular sound attenuators made of perforated aluminium surrounded with glass wool insulation and a PE vapour barrier

DIMENSIONS

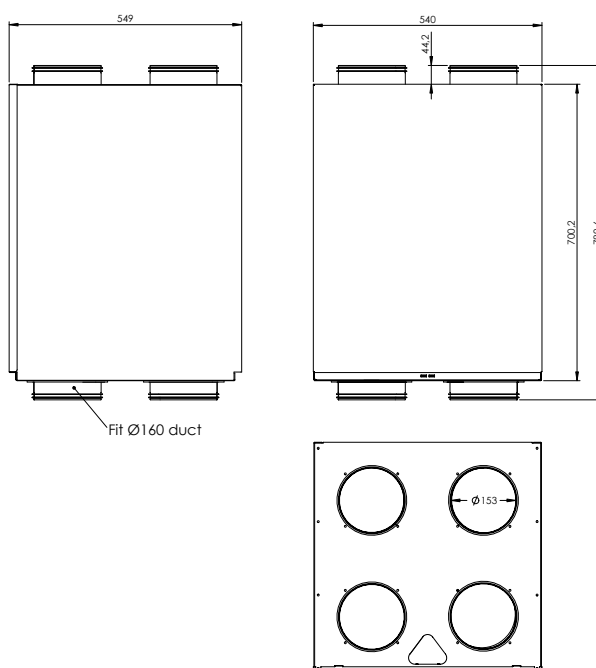

ACCESSORIES

SILENCER

The HCV 400-460 Silencer Box significantly reduces fan and air flow noise. The tables below illustrate the sound data with the Silencer Box installed, and can be compared with the sound data tables of the respective products in the wall-mounted units section of this catalogue.

HCV 400_{P1} SOUND DATA WITH G4/G4 FILTERS AND SILENCER BOX

Air flow	Pressure	Operational point	Sound effect Lw for centre frequency (1/1 octave)								Total sound power Lw(A)	Sound pressure 1m distance L_p(A)	Sound pressure 2m distance L_p(A)
			63Hz	125Hz	250Hz	500Hz	1000Hz	2000Hz	4000Hz	8000Hz			
m ³ /h	Pa		dB								dB(A)		
130	70	Supply	18.3	31.4	33.4	29.5	17.8	12.1	13.7	4.8	36.7		
		Extract	33.8	35.1	33.1	30.1	21.6	17.6	17.0	9.1	39.5		
		Outdoor	33.8	35.1	33.1	30.1	21.6	17.6	17.0	9.1	39.5		
		Exhaust	18.3	31.4	33.4	29.5	17.8	12.1	13.7	4.8	36.7		
		Cabinet										36.2	35.2
150	70	Supply	20.3	32.4	35.4	31.5	18.8	13.1	15.7	6.8	38.4		
		Extract	34.8	35.1	38.1	32.1	22.6	18.6	18.0	10.1	41.7		
		Outdoor	34.8	35.1	38.1	32.1	22.6	18.6	18.0	10.1	41.7		
		Exhaust	20.3	32.4	35.4	31.5	18.8	13.1	15.7	6.8	38.4		
		Cabinet										38.1	36.2
150	100	Supply	21.3	34.4	36.4	32.5	21.8	16.1	19.7	10.8	39.7		
		Extract	37.8	37.1	39.1	34.1	25.6	21.6	23.0	16.1	43.5		
		Outdoor	37.8	37.1	39.1	34.1	25.6	21.6	23.0	16.1	43.5		
		Exhaust	21.3	34.4	36.4	32.5	21.8	16.1	19.7	10.8	39.7		
		Cabinet										41.1	38.1
225	70	Supply	23.3	35.4	35.4	33.5	23.8	17.1	21.7	12.8	39.9		
		Extract	37.8	38.1	39.1	34.1	26.6	22.6	24.0	18.1	43.8		
		Outdoor	37.8	38.1	39.1	34.1	26.6	22.6	24.0	18.1	43.8		
		Exhaust	23.3	35.4	35.4	33.5	23.8	17.1	21.7	12.8	39.9		
		Cabinet										41.8	39.3
225	100	Supply	26.3	39.4	40.4	35.5	25.8	20.1	23.7	15.8	43.9		
		Extract	39.8	41.1	44.1	37.1	29.6	24.6	27.0	22.1	47.4		
		Outdoor	39.8	41.1	44.1	37.1	29.6	24.6	27.0	22.1	47.4		
		Exhaust	26.3	39.4	40.4	35.5	25.8	20.1	23.7	15.8	43.9		
		Cabinet										43.5	41.2
300	100	Supply	28.3	40.4	39.4	40.5	29.8	23.1	27.7	19.8	45.2		
		Extract	42.8	43.1	44.1	41.1	32.6	28.6	31.0	27.1	49.2		
		Outdoor	42.8	43.1	44.1	41.1	32.6	28.6	31.0	27.1	49.2		
		Exhaust	28.3	40.4	39.4	40.5	29.8	23.1	27.7	19.8	45.2		
												46.5	44.5

ACCESSORIES

SILENCER

HCV 400_{P2} SOUND DATA WITH G4/G4 FILTERS AND SILENCER BOX

Air flow	Pressure	Operational point	Sound effect Lw for centre frequency (1/1 octave)								Total sound power Lw(A)	Sound pressure 1m distance	Sound pressure 2m distance
			63Hz	125Hz	250Hz	500Hz	1000Hz	2000Hz	4000Hz	8000Hz			
m ³ /h	Pa		dB								dB(A)		
100	80	Supply	19.4	36.7	25.0	21.6	11.7	4.8	17.6	8.5	37.2		
		Extract	32.9	39.1	24.6	25.7	13.7	9.4	18.2	16.5	40.4		
		Outdoor	32.9	39.1	24.6	25.7	13.7	9.4	18.2	16.5	40.4		
		Exhaust	19.4	36.7	25.0	21.6	11.7	4.8	17.6	8.5	37.2		
		Cabinet										33.4	31.2
150	100	Supply	27.6	37.3	38.0	32.0	21.3	14.0	18.7	16.5	41.5		
		Extract	40.5	41.3	38.0	36.3	23.0	15.9	19.2	16.5	45.5		
		Outdoor	40.5	41.3	38.0	36.3	23.0	15.9	19.2	16.5	45.5		
		Exhaust	27.6	37.3	38.0	32.0	21.3	14.0	18.7	16.5	41.5		
		Cabinet										40.9	38.3
240	200	Supply	34.0	40.2	47.9	41.8	30.4	22.1	21.2	19.8			
		Extract	47.0	46.9	47.2	44.1	32.5	24.5	24.9	21.0			
		Outdoor	47.0	46.9	47.2	44.1	32.5	24.5	24.9	21.0			
		Exhaust	34.0	40.2	47.9	41.8	30.4	22.1	21.2	19.8			
		Cabinet											

HCV 400_{E1} SOUND DATA WITH G4/G4 FILTERS AND SILENCER BOX

Air flow	Pressure	Operational point	Sound effect Lw for centre frequency (1/1 octave)								Total sound power Lw(A)	Sound pressure 1m distance	Sound pressure 2m distance
			63Hz	125Hz	250Hz	500Hz	1000Hz	2000Hz	4000Hz	8000Hz			
m ³ /h	Pa		dB								dB(A)		
100	80	Supply	17.0	36.2	33.7	26.5	16.9	10.0	16.1	0.0	38.5		
		Extract	35.9	37.3	30.9	30.0	19.7	16.0	16.6	7.9	40.7		
		Outdoor	35.9	37.3	30.9	30.0	19.7	16.0	16.6	7.9	40.7		
		Exhaust	17.0	36.2	33.7	26.5	16.9	10.0	16.1	0.0	38.5		
		Cabinet										33.7	32.8
150	100	Supply	21.8	35.9	39.0	30.5	21.5	13.9	18.3	11.7	41.2		
		Extract	38.8	39.5	42.3	35.9	23.0	17.1	18.7	11.6	45.8		
		Outdoor	38.8	39.5	42.3	35.9	23.0	17.1	18.7	11.6	45.8		
		Exhaust	21.8	35.9	39.0	30.5	21.5	13.9	18.3	11.7	41.2		
		Cabinet										40.7	39
240	200	Supply	30.2	39.0	41.6	39.4	28.9	20.5	20.6	20.7	45.2		
		Extract	41.8	43.5	47.1	41.5	31.0	23.9	22.7	22.8	50.2		
		Outdoor	41.8	43.5	47.1	41.5	31.0	23.9	22.7	22.8	50.2		
		Exhaust	30.2	39.0	41.6	39.4	28.9	20.5	20.6	20.7	45.2		
		Cabinet										48.6	46.5

ACCESSORIES FILTERS

BUY ONLINE
shop.dantherm.com



Most models use 50mm **G4 cartridge** filters as standard for both supply air and extract air. This will cater to the majority of air cleaning needs. The advantage of compact filters is that they have a considerably larger filter surface area than fibrous filters and small bag filters. The filter thus works for longer and under normal conditions it will not need changing more often than twice a year, equivalent to the filter timer setting.

F7 filters (pollen filters): If necessary, F7 filters are available as accessories, which ensure that allergens do not enter the home through the ventilation system.











All filters are available to buy online, including those for out-phased units.

Illustration	Accessory	Description	HCV 300	HCV 400	HCV 460	HCV 500	HCV 700	HCH 5	HCH 8	RCV 320	HCC 2	HCC 260P1	HCC 360E1	HCC 360P2
	093844	HCV 300 – Panel filter set, F7/G4 One F7 filter and one G4 filter.	•											
	093845	HCV 300 – Panel filter set, G4 Two G4 filters.	•											
	098346	HCV 400 – Panel filter set, F7/G4 One F7 filter and one G4 filter.		•	•									
	098347	HCV 400 – Panel filter set, G4 Two G4 filters.		•	•									
	096393	HCV 500 – Panel filter set, F7/G4 One F7 filter and one G4 filter.				•								
	087342	HCV 500 – Panel filter set, G4 Two G4 filters.				•								
	093479	HCV 700 – Panel filter set, F7/G4 One F7 filter and one G4 filter.					•							
	093478	HCV 700 – Panel filter set, G4 Two G4 filters.					•							
	063448	HCH 5 – Panel filter set, F7/G4 One F7 filter and one G4 filter.						•						
	063470	HCH 5 – Panel filter set, G4 Two G4 filters.						•						
	063449	HCH 8 – Panel filter set, F7/G4 One F7 filter and one G4 filter.							•					
	063471	HCH 8 – Panel filter set, G4 Two G4 filters.							•					
	087998	HCC 2 – Panel filter set, F7/G4 One F7 filter and one G4 filter.									•	•	•	•
	087997	HCC 2 – Panel filter set, G4 Two G4 filters.									•	•	•	•
	111174	RCV 320 – Panel filter set, G4 Two G4 filters.								•				
	111175	RCV 320 – Panel filter set, F7/G4 One F7 filter and one G4 filter.								•				

ACCESSORIES

PRE/AFTER WATER HEATING COILS

Pre- and after-heating coils are effective solutions to regulate the air temperature, with preheating coils an excellent choice for preventing ice building up in the heat exchanger at low temperatures, and post-heating coils effective at increasing the supply air temperature.

Illustration	Accessory	Description	HCV 300	HCV 400	HCV 460	HCV 500	HCV 700	HCH 5	HCH 8	RCV 320 P2	HCC 2	HCC 260 P1	HCC 360 E1	HCC 360P2
	063843	Water heating coil set, Ø125mm The set includes water heating coils with 2RR, two-way water valve, 0-10V servo motor, 230/24V VAC trafo, duct sensor and tube sensor for frost protection. To be controlled by the accessory control HAC.	•							•	•	•	•	•
 Servo motor	063851	Water heating coil set, Ø160mm The set includes water heating coils with 2RR, two-way water valve, 0-10V servo motor, 230/24V VAC trafo, duct sensor and tube sensor for frost protection. To be controlled by the accessory control HAC.		•	•	•		•		•	•	•	•	•
 Two-way water valve	063852	Water heating coil set, Ø250mm The set includes water heating coils with 2RR, two-way water valve, 0-10V servo motor, 230/24V VAC trafo, duct sensor and tube sensor for frost protection. To be controlled by the accessory control HAC.					•		•					
 230/24 V VAC trafo														
	076107	Preheating coil, 700W For building into the unit.	•											
	098268	Preheating coil, 1400W For building into the unit.		•										
	108639	Preheating coil, 1850W For building into the unit.			•									
	115124	Preheating coil, 1400W For building into the unit.				•		•						
	076108	Preheating coil, 2 x 600W For building into the unit.				•								
	076109	Preheating coil, 2 x 800W For building into the unit.					•							
	110459	Preheating coil, 1 x 900W For building into the unit.								•				

PRE/AFTER WATER HEATING COILS FEATURES

**Water heating coils**

The water heating coil kit includes 2RR, 2-way water valve, 0-10V servo motor, 230/24VAC trafo, duct sensor and tube sensor for frost protection. It is controlled by the accessory control HAC 2.

CWW 125-2-2.5		Max capacity						Supply air temperature 21°C					
		80°C/60°C			60°C/40°C			80°C/60°C			60°C/40°C		
Air volume	m ³ /h	85	150	215	85	150	215	85	150	215	85	150	215
Air temperature out	°C	40	36	34	28	25	23	21	21	21	21	21	21
Pressure loss	Pa	11	28	51	11	28	51	11	28	51	11	28	51
Capacity	kW	0.7	1.1	1.4	0.4	0.5	0.6	0.2	0.3	0.5	0.2	0.3	0.5
Water flow	L/h	36	36	72	36	36	36	9	10	23	17	22	28
Pressure loss, max.	KPa	0.5	0.5	1	0.5	0.5	0.5	0.2	0.2	0.4	0.3	0.4	0.5

CWW 160-2-2.5**		Max capacity						Supply air temperature 21°C					
		80°C/60°C			60°C/40°C			80°C/60°C			60°C/40°C		
Air volume	m ³ /h	145	250	335	145	250	335	145	250	335	145	250	335
Air temperature out	°C	47	43	40	33	31	29	21	21	21	21	21	21
Pressure loss	Pa	6	15	27	6	15	27	6	15	27	6	15	27
Capacity	kW	1.6	2.4	3.0	0.9	1.3	1.7	0.3	0.5	0.7	0.3	0.5	0.7
Water flow	L/h	72	108	144	36	72	72	14	24	35	12	28	30
Pressure loss, max.	KPa	1	3	4	0.5	1	2	0.2	0.4	0.5	0.1	0.4	0.5

CWW 250-2-2.5***		Max capacity						Supply air temperature 21°C			
		80°C/60°C		60°C/40°C		80°C/60°C		60°C/40°C			
Air volume	m ³ /h	360	630	630	360	360	630	360	630		
Air temperature out	°C	44	40	31	29	21	21	21	21		
Pressure loss	Pa	10	25	10	25	10	25	10	25		
Capacity	kW	3.6	5.3	2.0	3.0	0.74	1.29	0.74	1.28		
Water flow	L/h	72144	252	108	144	30	61	40	61		
Pressure loss, max.	KPa	1	3	1	2	0.5	1.0	0.7	1.0		

*Air in 15°C.

** Please note that this heater coil has 160mm duct connections, so 2 pcs of Ø160/200mm duct reduction parts are needed for installation with a HCV 700 (Ø200).

*** Please note that this heater coil has 250mm duct connections, so 2 pcs of Ø200/250mm duct reduction parts are needed for installation with a HCV 700 (Ø200).

PRE/AFTER WATER HEATING COILS FEATURES

WEIGHT



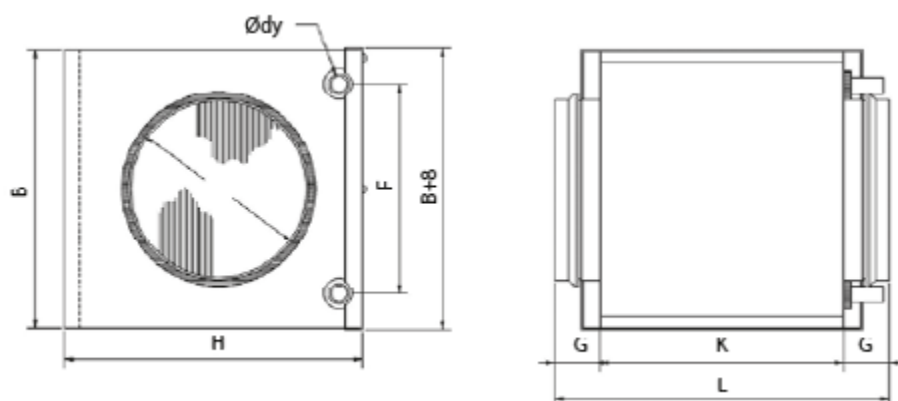

	$\varnothing d$	B	H	$\varnothing dy$	F	G	K	L	Weight
	mm								
CWW 125-2-2.5	125	238	180	10	137	40	276	356	3.5
CWW 160-2-2.5	160	313	255	10	212	40	276	356	5.4
CWW 250-2-2.5	250	398	330	10	250	40	276	356	7.7

DIMENSIONS



ACCESSORIES

PRE/AFTER HEATERS

Illustration	Accessory	Description	HCV 300	HCV 400	HCV 460	HCV 500	HCV 700	HCH 5	HCH 8	RCV 320 P1	HCC 2	HCC 260 P1	HCC 360
	063853	Electric pre-/after heating coil, Ø125mm, 900W stand-alone The set includes a 900W electric heater with duct sensor and built-in thermostat control. Direct control by the built-in thermostat, with no connection to the ventilation unit.	▼							▼	▼	▼	▼
	063854	Electric pre-/after heating coil, Ø160mm, 1200W stand-alone The set includes a 1200W electric heater with duct sensor and built-in thermostat control. Direct control by the built-in thermostat, with no connection to the ventilation unit.		▼		▼	▼	●					
	063855	Electric pre-/after heating coil, Ø250mm, 1800W stand-alone The set includes a 1800W electric heater with duct sensor and built-in thermostat control. Direct control by the built-in thermostat, with no connection to the ventilation unit.					▼		●				
	063898	Electrical pre-/after heater kit, Ø125mm, 900W, 0-10V controlled The set includes a 900W heater, integrated 0-10V regulation and a duct sensor. Must be controlled from the accessory control HAC.	▼							▼			
	063899	Electrical pre-/after heater kit, Ø160mm, 1200W, 0-10V controlled The set includes a 1200W heater, integrated 0-10V regulation and a duct sensor. Must be controlled from the accessory control HAC.		▼	▼	▼	▼	●					
	063900	Electrical pre-/after heater kit, Ø250mm, 1800W, 0-10V controlled The set includes a 1800W heater, integrated 0-10V regulation and a duct sensor. Must be controlled from the accessory control HAC.					▼		●				
	086877	External electric preheating coil, 900W The set includes a 900W heater and a power cable. The heater is controlled and powered by the main PCB of the HCC unit.									●	●	●
		External electric preheating coil, 1200W The set includes a 1200W heater and a power cable. The heater is controlled and powered by the main PCB of the unit.								●			

▼ Only used for after heating.

PRE/AFTER HEATERS FEATURES



Circular electric duct heater for reheating of supply air

The electric duct heater is designed for installation in the supply air duct. The duct heater is provided with duct connections with a rubber sealing gasket. The duct heater is not suitable for outdoor installation. The control current is connected to the accessory control HAC 2. Connection to supply voltage 230V is made separately. The duct heater is controlled by a stepless regulation via the accessory control HAC 2.

Circular electric duct heater, direct control by the built-in thermostat

This duct heater is controlled by the built-in thermostat. Both heaters are supplied with a duct sensor.

Capacity, dimensions and weight

The duct heaters are without fins and therefore the resulting air pressure loss is negligible.

Specifications	Units	063853	063854	063855
Air volume	m ³ /h	180	300	450
Heat output	kW	0.9	1.2	1.8
Temperature rise	°C	16.8	14.2	3.4
Power consumption, 1 x 230V	A	4.1	5.5	8.2
Duct connection	Ø mm	125	160	250
Weight	kg	3.0	3.5	5.0

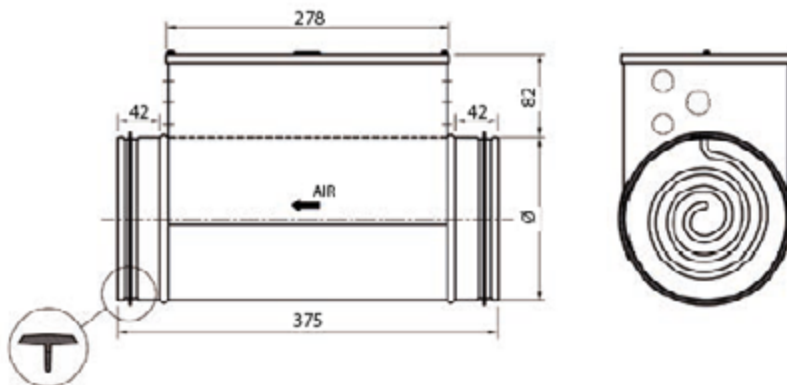

DIMENSIONS



ACCESSORIES

ENTHALPY HEAT EXCHANGERS











Heat recovery takes place in a highly efficient counter-flow heat exchanger, which is able to achieve optimum efficiency with the least possible loss of pressure in connection with the low air volumes used in housing. Transferring the humidity from the extract air to the fresh supply air prevents a dry indoor climate during wintertime. In the summer, when the relative humidity of the outdoor air is high, supply air will be dehumidified when passing through the enthalpy exchanger. This makes the supply air feel comfortably cold. Because of their superb ability to recover both heat and humidity, enthalpy exchangers are known to reduce heating costs substantially.

Illustration	Accessory	Description	HCV 300	HCV 400 P1-P2	HCV 460P2	HCV 500	HCV 700	HCH 5	HCH 8	RCV 320	HCC 2	HCC 260P1	HCC 360P2
	099183	Enthalpy heat exchanger For SWOP solution. Separate box including installation, labelling, flow chart etc.		•	•					•			
	099229	Enthalpy heat exchanger For SWOP solution. Separate box including installation, labelling, flow chart etc.									•	•	•

When the heat exchanger has been swapped, you need to use the PC Tool to change the unit type to the right enthalpy variant (E1). To ensure correct air balance, you will subsequently have to recalibrate the unit.











ACCESSORIES

PLUGS AND CABLES

Illustration	Accessory	Description	HCV 300	HCV 400	HCV 460	HCV 500	HCV 700	HCH 5	HCH 8	RCV 320	HCC 2	HCC 260 P1	HCC 360
	087353	Condensate pump kit This condensate pump kit is designed for mounting on HCC 2 units where there is no safe drain with fall to a drainage or on units where the drain is too far away. The kit is furnished with a bracket for fixing it to the HCC 2 unit, a power supply cable for connection to the HCC 2 unit, pressure equalisation hose and drain hose.									•		
	108625	Condensate pump kit This condensate pump kit is designed for mounting on HCC 260 and HCC 360 units where there is no safe drain with fall to a drainage or on units where the drain is too far away.										•	•
	064885	Power supply, 230VAC - 24VDC for duct control The 24VDC power supply is used together with HAC if the ventilation unit is controlling duct damper motors.	•	•	•	•	•	•	•	•	•	•	•
	086861	Digital plug, 25 pcs This digital plug is connected to the control of the unit. This allows to override the following fan speed, fire/smoke/negative pressure/stop+alarm and high water level stop.	•	•	•	•	•			•	•	•	•
	087619	USB cable, 3m USB cable to be used in connection with software update of units and Dantherm PC Tool (HPT 1).	•	•	•	•	•			•	•	•	•
	099104	Cable for HCP 11, 20m Extension cable for the wired HCP 11 control.	•	•	•	•	•			•	•	•	•
	086853	Calibration set, 10 pcs Calibration set for air flow calibration. Including 3m silicone tube, suction cups and fittings.	•	•	•	•	•			•	•	•	•
	062737	Siphon trap kit Including 2m 3/4" hose.						•	•				
	064807	Heat cable, 3m 230V, 10W/m including 5°C thermostat. For frost protection of condensate hose.						•	•				
	063887	Communication cable, 30m Cable with plug for connection of control panel to the HCH unit.						•	•				
	096427	Communication cable, 10m Cable with plug for connection of control panel to the HCH unit.						•	•				



ACCESSORIES

INSTALLATION ACCESSORIES

Illustration	Accessory	Description	HCV 300	HCV 400	HCV 460	HCV 500	HCV 700	HCH 5	HCH 8	RCV 320	HCC 2	HCC 260 P1	HCC 360
	053730	Floor stand Height 230mm and adjustable feet. RAL 9016 Traffic white.	•										
	099220	Floor stand Height 120mm and adjustable feet. RAL 9016 Traffic white.		•	•					•			
		Floor stand Alu-zink.		•	•					•			
	052423	Floor stand Height 230mm and adjustable feet. RAL 9016 Traffic white.				•	•						
	098251	Mounting attrap, 2 sets To indicate the mounting dimensions in advance, without using the real unit. Includes 2 x mounting attrap + 2 x wall rails.		•	•								
	098426	Mounting attrap To indicate the mounting dimensions in advance, without using the real unit. Includes 2 x mounting attrap + 2 x wall rails.	•										
	052250	Inspection door 730 x 1200mm Mat white RAL 9016 with key.									•	•	•
	052251	Inspection door with sound insulation 730 x 1200mm Mat white RAL 9016 with key.									•	•	•
	052252	Inspection door 730 x 1500mm Mat white RAL 9016 with key.									•	•	•
	052254	Inspection door with sound insulation 730 x 1500mm Mat white RAL 9016 with key.									•	•	•
	111176	Oval duct adaptor PE-HD adaptor to connect an oval duct. The integrated lip seal provides an airtight connection between the pipe and the adaptor. The oval duct adaptor is suitable for supply air.								•			

ACCESSORIES

DISPLAY KITS

Illustration	Accessory	Description	HCV 300	HCV 400	HCV 460	HCV 500	HCV 700	HCH 5	HCH 8	RCV 320	HCC 2	HCC 260 P1	HCC 360
	051958	Display kit Kit including polycarbonate and mounting parts, flow chart and instructions.		•	•								
	051956	Display kit Kit including polycarbonate and mounting parts, flow chart and instructions.									•	•	•
	111173	Display kit Kit including polycarbonate and mounting parts, flow chart and instructions.							•				

CONTROLS



CONTROLS RANGE

QUICK GUIDE

PRODUCTS SUITABILITY



EMBEDDED CONTROL



FOIL PANEL



WIRELESS CONTROL



WIRED CONTROL



PC TOOL



MOBILE APP



HCV



RCV



HCC



HCH



CONTROLS PLATFORM SET UP

PLATFORM 2:

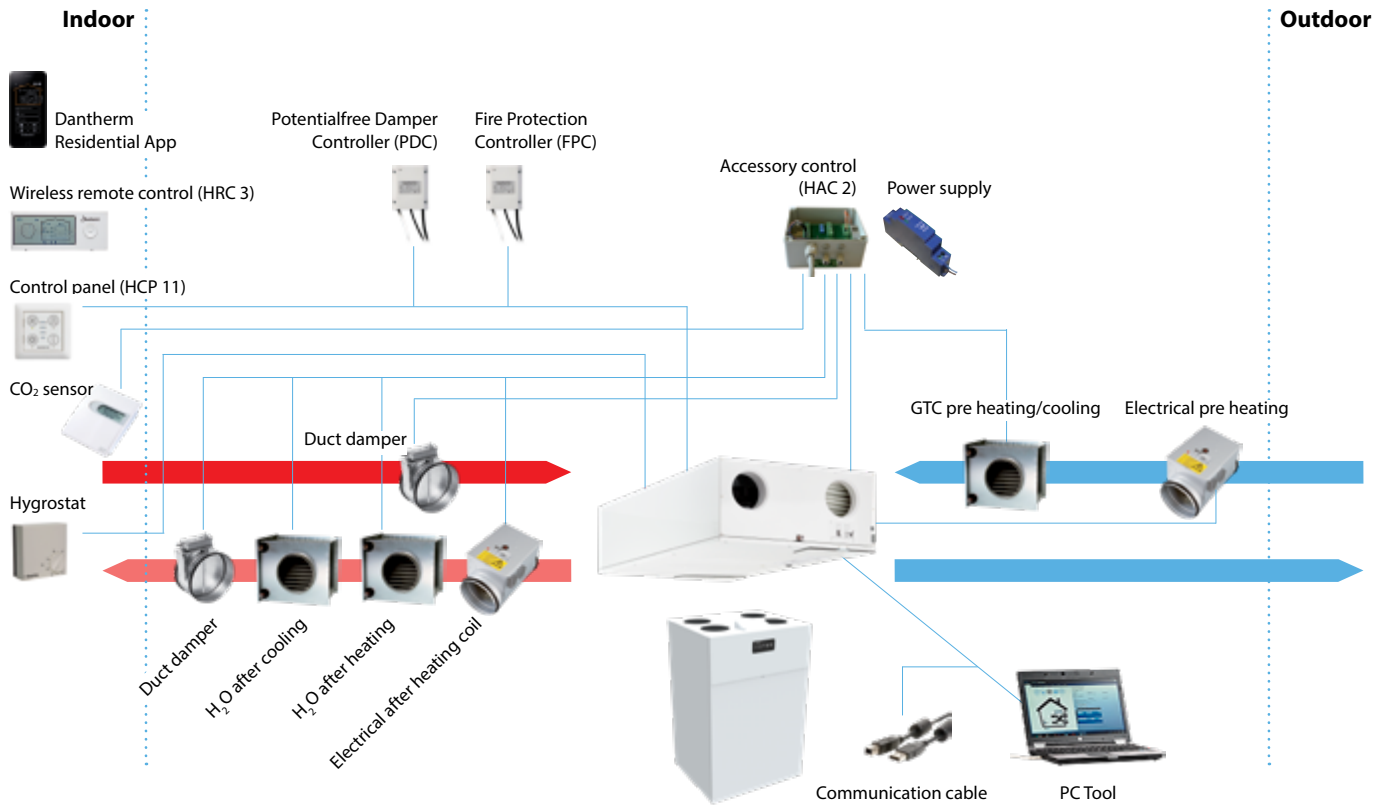

CONTROLS RANGE

EMBEDDED CONTROLS

HCV and HCC units have an embedded control which measures and adjusts all parameters continuously in order to maintain a correct ventilation level at the lowest possible energy consumption. The controller has a wide range of connections for both internal and external accessories.



Platform 2

The controller has a wide range of connections for both internal and external accessories.

For external connections, you will find:

- Wired LAN interface that supplies data communication to ModBus over TCP/IP
- Ideal for connection to external building management systems (BMS/CTS)
- ModBus over RS485: For HAC accessory control or wired control (HCP 11)
- Antenna socket for the wireless remote control antenna
- Two additional digital inputs that can be used for e.g. forced operation controlled by the hygrostat, cooker hood, fire protection or similarly

For more on internal accessories, please see the “Accessories” chapter.

The USB connection of the controller enables professional installers to carry out all adjustments and settings using the Dantherm PC Tool. The PC Tool is also capable of displaying both live and historic data for all unit components. This is crucially important in connection with maintenance, service and troubleshooting.

The USB port offers firmware update option.

The HCV units are secured against incorrect and uneconomical operation for long periods of time. Several of the functions return to default after four hours as a means of preventing excessive energy consumption, for instance if a unit is left running at maximum fan speed or in manual bypass mode. If you switch off the installation, it will automatically restart after four hours to ensure proper ventilation and to keep condensation from forming in the ducts and in the unit.

In emergency situations where there is a warning message about switching off ventilation systems and closing doors and windows, the supply current to the system must be interrupted by a safety switch or similarly.

CONTROLS RANGE

EMBEDDED CONTROLS

Control panel

The HCV unit has a built-in control panel with four buttons for controls, and nine LED feedback signals.

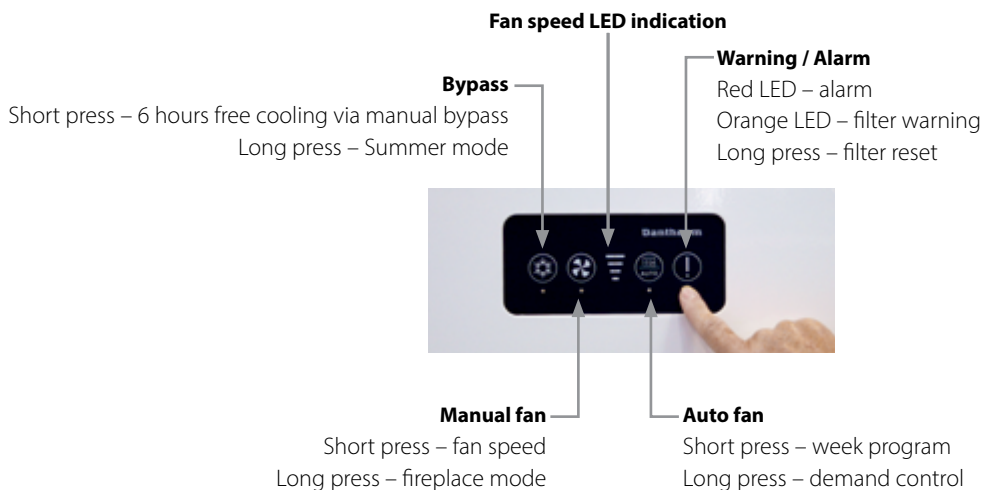

Fan control

During initial calibration, fan speed no. 3 is set on the control panel to the nominal air volume the house requires under normal usage.

The correlation between the four fan speeds on the control panel is as follows:

- Fan speed 0 = both fans stopped for 4 hours
- Fan speed 1 = 30% lower than fan speed 2
- Fan speed 2 = 30% lower than fan speed 3
- Fan speed 3 = nominal air change, set by installer during the initial calibration
- Fan speed 4 = 30% higher than fan speed 3 (4-hour time-out)

In demand-controlled mode with integrated humidity sensor, the maximum speed is step 3.

In demand-controlled mode with integrated VOC sensor or CO₂ sensor connected to the HAC 2, the maximum speed is step 4.

Filter control

The filter pressure is expected to increase between filter change intervals. To compensate for the reduced air volumes over time, the two fans run faster and faster until the filter alarm is triggered and the filter timer has been reset.

CONTROLS RANGE

WIRELESS REMOTE CONTROL

We offer a wireless remote control option, which can be mounted on the wall or placed on a shelf. The remote control is designed for the user, but also includes a special installer menu, allowing the installer to do extensive settings without the use of the PC Tool.

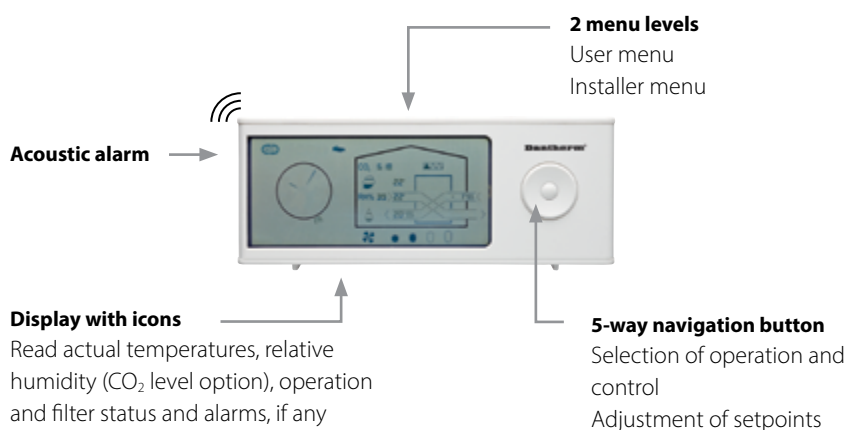

The user features are:

- Select fan speed in manual mode
- Select demand mode
- Select week mode, as well as selecting week program 1-11
- Manually activated by-pass
- Enable fireplace boost mode – seven minutes with overpressure inside the house for easy ignition of a fireplace
- Enable/disable away mode – the unit decreases permanently to fan speed 1
- Enable/disable night mode – the unit decreases to fan speed 1. The hour for enable/disable can be adjusted.
- Adjust filter timer duration
- Reset filter timer after filter exchange
- Reading air temperatures in the duct connections, including the remote controls embedded temperature sensor
- Setting time and date

The remote control has a visual/acoustic alarm that will sound when the filter needs to be inspected or replaced. This ensures correct maintenance even when the unit is set to demand mode and your attention is not at the remote control.

The wireless remote control uses two AAA alkaline batteries. Battery lifetime of up to two years is possible, as the display and remote shifts to hibernation mode after two minutes without user interaction. In addition, the remote is shut down at night.

Illustration	Code	Description	HCV 300	HCV 400	HCV 460	HCV 500	HCV 700	RCV 320	HCH 5	HCH 8	HCC 2	HCC 260 P1	HCC 360
	087953	Wireless remote control, HRC 3 Remote control with manual operation, demand-controlled operation, week program, away operation, night operation, readings and installer menu.	•	•	•	•	•	•	•	•	•	•	•

CONTROLS RANGE

WIRED CONTROL

Wired control (HCP)

This wired control comes with a white plastic frame and a metal frame for fastening into a standard junction box as well as a 6m communication cable. Alternatively, Dantherm can supply a box for fixing to the wall in an appropriate place.

The HCP 11 wired control gives the user the following possibilities :

- Manual control of air change (step 0-4)
- Control of air change with week program
- Demand controlled air change (when RH and VOC sensors are connected)
- Enable summer cooling mode (only extract air)
- Enable free cooling with bypass
- Enable fireplace mode
- Reading and resetting of alarms, including filter alarm

The installer can use the wired HCP 11 to adjust air volumes during commissioning.

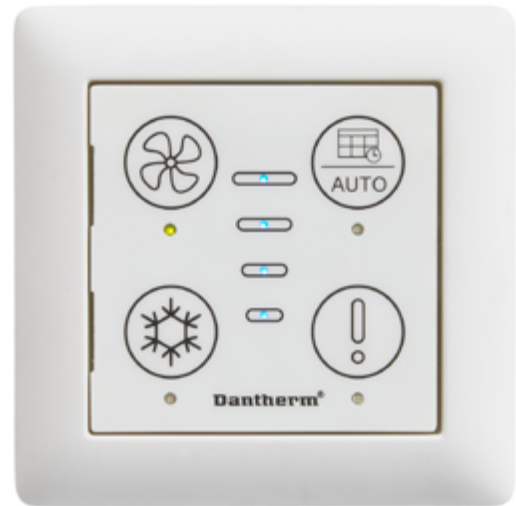



Illustration	Code	Description	HCV 300	HCV 400	HCV 460	HCV 500	HCV 700	HCH 5	HCH 8	RCV 320	HCC 2	HCC 260 P1	HCC 360
	052539	Wired control, HCP 11 With acoustic alarm. Fire protection control compatible. Wired control with manual control, week program, demand control, summer cooling mode, free cooling with bypass, fireplace mode as well as air flow settings. Including 6m cable.	•	•	•	•	•	•	•	•	•	•	•

CONTROLS RANGE PC TOOL



CALIBRATION VIA PC TOOL



CALIBRATION USING CONTROL PANEL



FILTER TIMER RESET

The Dantherm PC Tool is available for all units. Though its installer menu, the installer can easily adjust the unit, connect extra accessories, adjust various user settings, read and reset alarms, if any.

It also has a user menu, where the user can read and adjust various settings, such as week programs, set points, alarms and historical data about temperatures and air quality (accessory).



CONTROLS RANGE

DANTHERM APP

The Dantherm App, which is available for iOS and Android via the App store and Google play, offers a user-friendly and intuitive way to control the residential ventilation unit. The App is connected to the Wi-Fi router of the house. It is available for all HCV and HCC units.

The control options include:

- Demand control operation
- Manual operation
- Week program operation
- Night operation
- Manual bypass cooling
- Summer cooling.
- Fireplace mode
- Alarms
- Settings menu





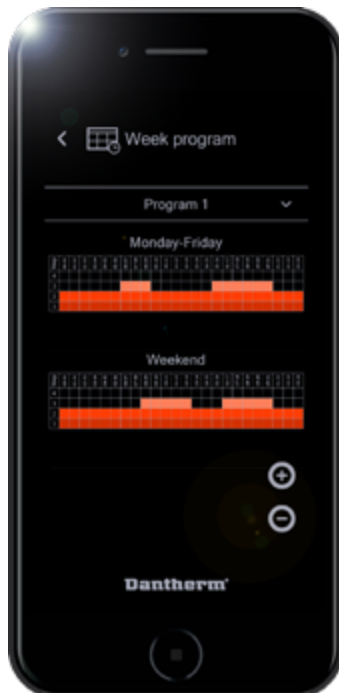







Easy to use! You can download it on Google Play or the App Store. Demo mode included.



CONTROL ACCESSORIES RANGE

A wide range of additional control accessories are available in order to cover any specific need for control and system optimisation.

Illustration	Accessory	Description	HCV 300	HCV 400	HCV 460	HCV 500	HCV 700	HCH 5	HCH 8	RCV 320	HCC 2	HCC 260 PT	HCC 360
	516301	Hygrostat The hygrostat measures the humidity in wet rooms. Ideal for high-humidity rooms requiring an increased air change, for instance bathrooms.	●	●	●	●	●	▼	▼	●	●	●	●
	113118-2	Humidity sensor, 700mm The RH% demand sensor will continuously monitor the humidity of the extract air and adjust the air flow level accordingly.									●	●	●
	111635-2	Air quality sensor, 700mm The VOC sensor will continuously monitor the level of artificial as well as natural organic fumes in the air and adjust the air flow level accordingly.									●	●	●
	113114-2	Humidity sensor, 480mm The RH% demand sensor will continuously monitor the humidity of the extract air and adjust the air flow level accordingly.	●	●	●	●	●	●	●	●			
	111633-2	Air quality sensor, 480mm The VOC sensor will continuously monitor the level of artificial as well as natural organic fumes in the air and adjust the air flow level accordingly.	●	●	●	●	●	●	●	●	●	●	●
	063874	CO₂ sensor For control of air change accordance with the CO ₂ level in a given room.	●	●	●	●	●	●	●	●	●	●	●
	096984	Antenna extender 5m.		●	●								
	098084	Potentialfree Damper Controller (PDC) For potential free ON/OFF control of damper motor. Up to 4 PDC per ventilation unit.	●	●	●	●	●	●	●	●	●	●	●
	098083	Fire Protection Controller (FPC) For connection of fire and smoke damper or smoke damper. Up to 4 FPC per ventilation unit.	●	●	●	●	●	●	●	●	●	●	●
	077138	Accessory control, HAC 2 For control of heating coils, geothermal pre-cooling/heating coils, duct dampers, stop function input, fire thermostat, CO ₂ sensor, hygrostat and alarms. Including 3m cable.	●	●	●	●	●	●	●	●	●	●	●

▼ Unit needs a HAC 1 to connect the hygrostat.

CONTROLS ACCESSORIES

HAC AND SENSORS



Accessory control HAC 2

Accessory control HAC 2

One or more of the following functions can be connected to the accessory control:

- After heating coils for water or electricity
- Geothermal preheating/pre-cooling coils
- 24 VDC duct damper outlet
- Stop function inlet
- Fire/smoke detector inlet
- External CO₂ sensor for demand control
- External hygrostat
- Filter alarm outlet
- General alarm

HAC 2 comes with 3m cable.



VOC air quality demand sensor

VOC air quality demand sensors

The unit can be fitted with a VOC air quality sensor. This sensor will continuously monitor the level of artificial as well as natural organic fumes in the air.

Examples of included fumes:

- Natural fumes, e.g. formaldehyde from building materials
- Chemical fumes from sprays, e.g. hair spray or perfumes
- Indoor pollution e.g. from smoking and printing with laser printer
- Fumes from fire-retardant substances in carpets, paint and furniture

Using the VOC sensor in demand mode will result in the correct level of ventilation with the lowest possible power consumption. If a wireless remote control or App is connected, the actual VOC level will be shown in the display using a 3 level icon.



Humidity sensor

Humidity RH% demand sensor

The ventilation units can be fitted with a humidity sensor (RH%). This sensor will continuously monitor the humidity of the extract air and adjust the air flow level in accordance with the demand of the home. Using demand mode will ensure the correct level of ventilation at the lowest possible electrical power consumption. The level of humidity is indicated in the Dantherm App as well as the wireless remote control (if connected). If VOC, CO₂ and RH% sensors have been fitted, the ventilation level will be determined by the sensor that detects the highest demand.

CONTROLS ACCESSORIES

FIRE PROTECTION CONTROLLER (FPC)

The Fire Protection Controller (FPC) is a unit that controls a fire damper for fire and smoke protection purposes. The unit has been designed for Belimo or similar fire damper actuators fitted with spring-return and position feedback. The fire damper actuator is connected directly to the FPC, and then controlled via the ventilation system. Each FPC is to be addressed individually. Up to four FPCs can be connected to one ventilation unit.

The FPC is fitted with LED lamps indicating the damper position and status, and a digital input socket for surveillance if so required in your installation, for instance for a thermostat or a smoke detector.



Fire Protection Controller (FPC)

Features

- Easy cable installation
- Individual alarm and damper status
- Digital input for thermostat or smoke detector for surveillance where required
- LED lamps indicate damper position and status
- Weekly or monthly self-test

For decentralised ventilation applications, the most frequently used solution is to lead exhaust air from each apartment and to the roof through separate air ducts. The ducts are fireproofed and joined in one exhaust air cowl. Such a solution often requires more ventilation shaft space than available, particularly in connection with renovation projects. Instead, the exhaust air can be removed using one joint air duct. But that requires fire and smoke dampers, fire thermostats and external automatic fire protection. Until now, this has dramatically increased the price of renovation projects.

Keeping installation costs for projects with joint air ducts at a very competitive level, Dantherm's new residential ventilation units have been fully prepared for control of fire and smoke dampers by means of the FPC.

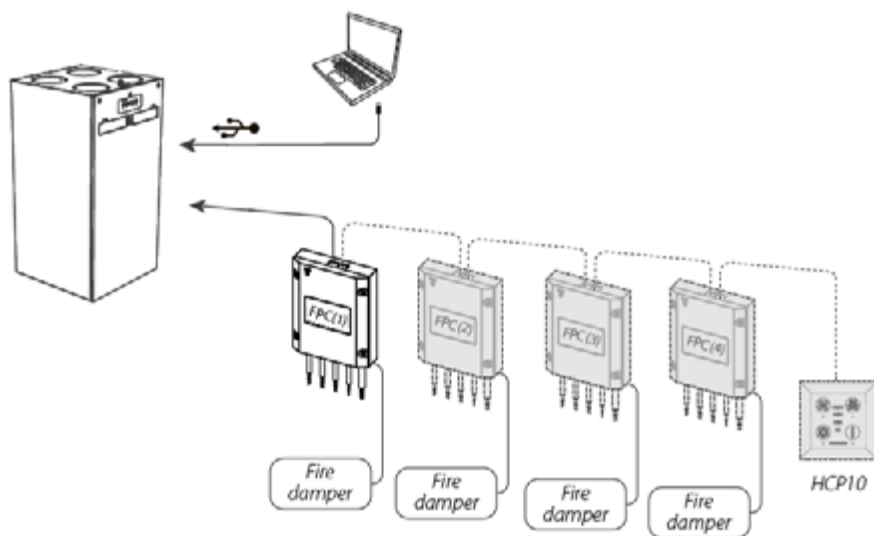

Fire Protection Controller set-up



Dimensions

FIRE PROTECTION CONTROLLER (FPC)

The ventilation unit controls the FPC which in turn controls the fire and smoke dampers by means of the connected fire thermostats and smoke sensors. When a fire is detected, the ventilation unit is shut down and the fire and smoke dampers are closed. That stops smoke from spreading to other apartments. The ventilation keeps running in apartments where there is no fire.

Fire control features:

Activation of the digital input, for instance if fire or smoke is detected

- The ventilation unit is shut down
- The fire and smoke damper is closed

Loss of power or stopped ventilation unit

- The fire and smoke damper is closed

Faulty components, wiring and bus communication

- The ventilation unit is shut down
- The fire and smoke damper is closed
- The ventilation unit displays an FPC error and logs it in the alarm log

Weekly or monthly self-test

- Shuts down the ventilation unit, closes the fire and smoke damper and tests the position feedback
- Opens the fire and smoke damper, tests the position feedback and powers up the ventilation unit
- If faults are registered, the fire damper is closed, the ventilation unit is shut down and the display will report an error which will be registered in the alarm log

Manual test activated using the PC Tool in connection with

- Annual testing of automatic control as well as fire and smoke dampers
- Testing before apartment occupancy

After faults, the ventilation units must be reset manually using the control panel. Automatic and manual tests are registered in the alarm log of the unit.

Power	Unit	Connection
Damper motor supply	24V/230V AC	Terminal 1&2 Wago cage clamp
Position feedback Digital input for dry contact use SPDT connections for open/close feedback	12V/12mA	Terminal S1-S6 Wago cage clamp
Thermostat/smoke detector For dry contact use	12V/12mA	Terminal 10-11 Wago cage clamp
RS 485 communication ModBus RTU protocol	12V/A-B	RJ11 696C
Power consumption		Max 100mA

DENMARK

Dantherm A/S
DK-7800 Skive
+45 96 14 37 00
sales.dk@dantherm.com

GERMANY

Dantherm GmbH
22844 Norderstedt
+49 40 526 8790
sales.de@dantherm.com

ITALY

Dantherm S.p.A.
37010 Pastrengo (VR)
+39 045 6770533

62012 Civitanova Marche (MC)
+39 0733 714368
sales.it@dantherm.com

SPAIN

Dantherm SP S.A.
28108 Alcobendas, Madrid
+34 91 661 45 00

46980 Paterna, Valencia
+34 961 524 866
sales.es@dantherm.com

UNITED KINGDOM

Dantherm Ltd
Maldon CM9 4XD
+44 (0)1621 856611
sales.uk@dantherm.com

FRANCE

Dantherm SAS
69694 Vénissieux Cedex
+33 4 78 47 11 11
sales.fr@dantherm.com

POLAND

Dantherm Sp. z o.o.
62-023 Gądko
+48 61 65 44 000
sales.pl@dantherm.com

NORWAY

Dantherm AS
3138 Skallestad
+47 33 35 16 00
sales.no@dantherm.com

SWEDEN

Dantherm AB
602 13 Norrköping
+46 (0)11 19 30 40
sales.se@dantherm.com

RUSSIA

Dantherm LLC
142800, Stupino
Moscow
+7 (495) 642 444 8
sales.ru@dantherm.com

SWITZERLAND

AirCenter AG
CH-5405 Baden Dättwil
+41 43 500 00 50
info@aircenter.ch

CHINA

MCS China
Baoshang, Shanghai, 201906
+8621 61486668
sales.cn@dantherm.com

Dealer:

KEEP UPDATED
FOLLOW US ON:



danthermgroup.com